

RADIO'S LIVEST MAGAZINE

SPECIAL  
ELECTRONICS  
NUMBER

OVER 175 ILLUSTRATIONS

RCA  
150  
Radio  
Expander  
**Radio-Craft**

HUGO GERNSBACH EDITOR

April  
25 Cents

In United States  
and Canada

**8,000-VOLT  
RECTIFIER!**

See Page 670

Developments in Electronic Music — Circuit Features of New Test Units  
New! — The "Audio Expressor" for P. A. Systems — Radio Waves Control Set!

OVER 50,000 RADIO MEN READ RADIO-CRAFT MONTHLY

# NEW!

# -AN A. C. OSCILLATOR THAT HOLDS ITS ACCURACY

(Individually hand calibrated dials)

**ACCURATE** frequency calibration assured by large 330° fully visible *hand calibrated* dial! (No troublesome trimmers or padders used.)

**UNIFORM** output level regardless of frequency assured by new WESTON A.A.C. circuit. Tuning oscillator or shifting frequency band does not increase or decrease signal strength.

**CONSTANT** signal free from drift or shift in frequency assured by A. A. C. circuit which automatically regulates mutual conductance of oscillator tube.

**COMPLETE** attenuation of signal on all bands assured by new WESTON design, thorough double shielding, and elimination of line feedback.

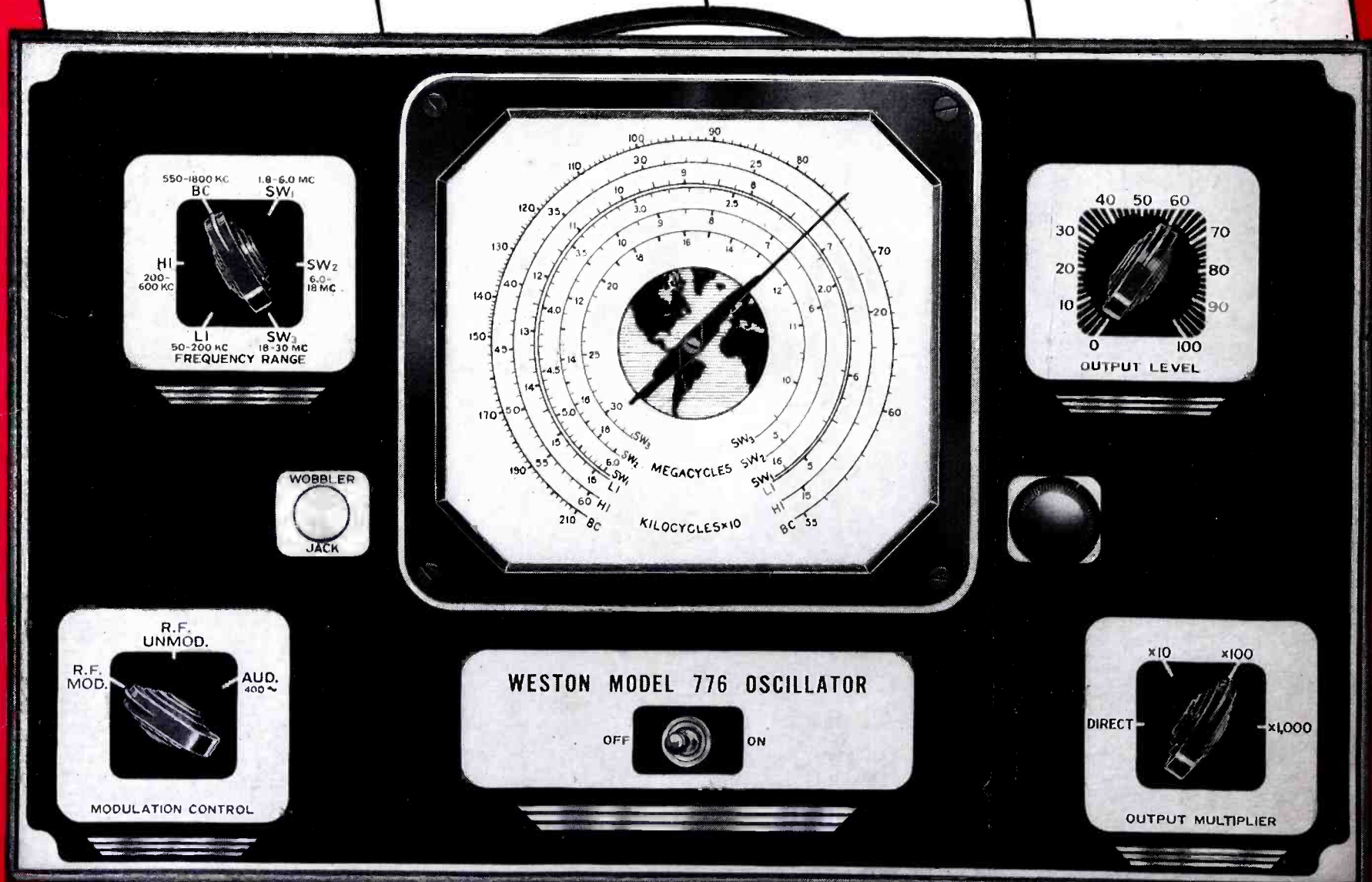

The above 4 features, heretofore available only in high priced laboratory oscillators . . . yet recognized as essential for thorough radio servicing . . . now are available *for the first time* in a practical service oscillator, *at a serviceman's price*. The new WESTON Model 776 Oscillator gives you all "four," *plus* 12

additional features and refinements. In addition, it has been styled to match other recent and widely popular instruments in the WESTON line. You will want all the facts on Model 776 . . . a serviceman's oscillator that fully meets WESTON'S high standards of accuracy and durability. The coupon will bring you complete literature.

Weston Electrical Instrument Corp.,  
599 Frelinghuysen Ave., Newark, N. J.

Send data on Model 776 Oscillator.

Name.....

Address.....

City..... State.....

# WESTON Instruments



**J. E. SMITH**  
President  
National Radio  
Institute  
Established 1914  
The man who has  
directed the  
home study train-  
ing of more men  
for the Radio In-  
dustry than any  
other man in  
America.

# I WILL TRAIN YOU TO START A SPARE TIME OR FULL TIME RADIO SERVICE BUSINESS WITHOUT CAPITAL

**HERE ARE A FEW EXAMPLES  
OF THE KIND OF MONEY  
I TRAIN MY MEN TO MAKE**



**\$200 TO \$300 A MONTH IN OWN  
BUSINESS**

"For the last 18 months I have been in business for myself, making between \$200 and \$300 a month. I have N.R.I. to thank for my start in this field."—**ARLIE J. FROEHNEB**, 224 W. Texas Ave., Goose Creek, Texas.

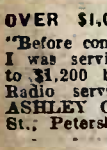

**OVER \$1,000 BEFORE GRADUATING**

"Before completing half the N.R.I. Course I was servicing sets, and I made \$1,000 to \$1,200 before graduating. I am doing Radio service work for myself now."—**ASHLEY G. ALDRIDGE**, 1228 Shepherd St., Petersburg, Va.



**CHIEF OPERATOR BROADCASTING  
STATION**

"When I completed 20 lessons, I obtained my Radio Broadcast Operator's License and immediately joined Station WMPC, where I am now Chief Operator."—**HOLLIS F. HAYES**, 85 Madison St., Lapeer, Mich.

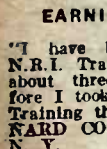

**EARNINGS TRIPLED BY N.R.I.  
TRAINING**

"I have been doing nicely, thanks to N.R.I. Training. My present earnings are about three times what they were before I took the Course. I consider N.R.I. Training the finest in the world."—**BERNARD COSTA**, 201 Kent St., Brooklyn, N. Y.



**Get My LESSON on  
Radio Servicing Tips FREE**

I'll prove that my Training gives practical, money-making information, that it is easy to understand—that it is just what you need to master Radio. My sample lesson text, "Radio Receiver Troubles—Their Cause and Remedy" covers a long list of Radio receiver troubles in A.C., D.C., battery, universal, auto, T. R. F., superheterodyne, all-wave, and other types of sets. And a cross reference system gives you the probable cause and a quick way to locate and remedy these set troubles. A special section is devoted to receiver check-up, alignment, balancing, neutralizing, testing. You can get this lesson Free by mailing the coupon.



**MAIL  
COUPON  
NOW**

**The Tested Way  
to BETTER PAY**

Do you want to make more money? The worldwide use of Radio has made many opportunities for you to have a spare time or full time Radio service business of your own. Three out of every four homes in the United States have Radio sets which regularly require repairs, servicing, new tubes, etc. Servicemen can earn good commissions selling new sets to owners of old models. I will train you at home in your spare time to sell, install, service, all types of Radio sets to start your own Radio business and build it up on money you make in your spare time while learning. Mail coupon for my 64-page book. It's Free—it shows what I have done for others—what I am ready to do for you.

**Many Make \$5, \$10, \$15 a Week Extra  
in Spare Time While Learning**

Almost every neighborhood needs a good spare time serviceman. The day you enroll I start sending you Extra Money Job Sheets. They show you how to do Radio repair jobs, how to cash in quickly. Throughout your training I send you plans and ideas that have made good spare time money—from \$200 to \$500 a year—for hundreds of fellows. I send you special Radio equipment and show you how to conduct experiments and build circuits which illustrate important Radio principles. My training gives you PRACTICAL EXPERIENCE while learning.

**There's a Real Future in Radio  
For Well Trained Men**

Radio already gives jobs to more than 300,000 people. And in 1936, Radio enjoyed one of its most prosperous years. More than \$500,000,000 worth of sets, tubes and parts were sold—an increase of more than 60% over 1935. Over a million Auto Radios were sold, a big increase over 1935. 24,000,000 homes now have one or more Radio sets, and more than 4,000,000 autos are Radio equipped. Every year millions of these sets go out of date and are replaced with newer models. More millions need servicing, new tubes, repairs, etc. A few hundred \$30, \$50, \$75 a week jobs have grown to thousands in 20 years. And Radio is still a new industry—growing fast!

**Get Ready Now for Your Own Radio Business  
and for Jobs Like These**

Radio broadcasting stations employ engineers, operators, station managers and pay up to \$5,000 a year. Spare time Radio set servicing pays as much as \$200 to \$500 a year—full time jobs with Radio jobbers, manufacturers and dealers, as much as \$30, \$50, \$75 a week. Many Radio Experts own and operate their own full time or part time Radio sales and service businesses. Radio manufacturers and jobbers employ testers, inspectors, foremen, engineers, servicemen, paying up to \$6,000 a year. Radio operators on ships get

good pay, see the world besides. Automobile, police, aviation, commercial Radio, loud speaker systems are newer fields offering good opportunities. Television promises to open many good jobs soon. Men I have trained are holding good jobs in these branches of Radio. Read their statements in my 64-page book. Mail the coupon.

**I GIVE YOU A PROFESSIONAL  
SERVICING  
INSTRUMENT**

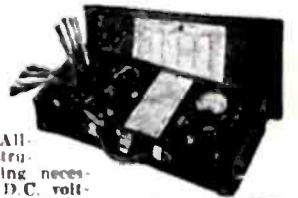

Here is the instrument every Radio expert needs and wants—an All-Wave, All-Purpose, Set Servicing Instrument. It contains everything necessary to measure A.C. and D.C. voltages and current; test tubes, resistance; adjust and align any set, old or new. It satisfies your needs for professional servicing after you graduate—can help you make extra money servicing sets while training.

**Save Money—Learn At Home  
Money Back Agreement Protects You**

I am sure I can train you at home successfully. I will agree in writing to refund every penny you pay me if you are not satisfied with my Lessons and Instruction Service when you finish my Course. I'll send you a copy of this agreement with my Book.

**Find Out What Radio Offers You  
Get My 64-Page Book Free Now**

Act Today. Mail the coupon now for my Free Lesson and my book, "Rich Rewards in Radio." Both are free to anyone over 16 years old. My book points out Radio's spare time and full time opportunities and those coming in Television; tells about my Training in Radio and Television; shows you letters from men I have trained, telling what they are doing and earning. Find out what Radio offers YOU! MAIL THE COUPON in an envelope, or paste it on a penny post card—NOW!

**J. E. SMITH, President,  
National Radio Institute  
Dept. 8DX  
Washington, D. C.**

**THIS  
FREE BOOK  
HAS HELPED  
HUNDREDS OF  
MEN MAKE  
MORE  
MONEY**

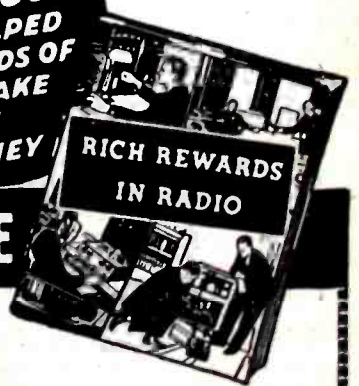

**GOOD FOR BOTH 64 PAGE BOOK FREE  
SAMPLE LESSON FREE**

J. E. SMITH, President, National Radio Institute, Dept. 8DX, Washington, D.C.

Without obligating me, send your Lesson "Radio Receiver Troubles—Their Cause and Remedy" and free book about spare time and full time Radio opportunities and how I can train for them at home in my spare time—about the N.R.I. Set Servicing Instrument you give me. I am particularly interested in the branch of Radio checked below.

- Radio Service Business of My Own
- Spare Time Radio Service Work
- Retail Sales of Radio Sets and Equipment
- Service Expert for Retail Stores
- Broadcasting Station Operator
- Aviation Radio Operator
- Ship Radio Operator

- Loud Speaker Systems, Installations and Service
- Auto Radio Installation and Service
- Television Station Operator
- Service Expert with Radio Factory
- Commercial Radio Station Operator
- All-around Servicing Expert

(If you have not decided which branch you prefer—mail coupon now, for information to help you decide.)

NAME ..... AGE .....

ADDRESS ..... 14X1

Please Say That You Saw It in RADIO-CRAFT



HUGO GERNSBACK, Editor-in-Chief  
 N. H. LESSEM Associate Editor ROBERT EICHBERG Associate Editor  
 R. D. WASHBURNE, Managing Editor

**CONTENTS — APRIL 1938, Issue**  
 Volume IX Number 10

Editorial: Electronic Wonders.....Hugo Gernsback	661
The Radio Month in Review.....	662
Radio in Pictures.....	664
American Technique in the Television Studio.....	665
Recent Developments in Electronic Music .....Benjamin F. Miessner	666
Outstanding Circuit Features of 1937 and '38 Service Instruments.....Alfred A. Ghirardi	668
India's New Network of Radio Broadcasting.....	670
New "Amplified" D.C. Meter.....	671
It's Easy to Build This "Browning-83" 4-Band Superhet. .....Glenn H. Browning	672
New! The Du Mont Television System .....Allen B. Du Mont	674
New! Audio "Expressor" for Sound Systems .....A. C. Shaney	676
International Radio Review.....	677
New Circuits in Modern Radio Receivers—No. 7 .....F. L. Sprayberry	678
Radio Waves Used to Completely Control Remote Receiver.....W. E. Shrage	679
A Direct-Reading Electronic "Flux" Meter .....Heinz Bouke	680
Short-Cuts in Radio.....	681
Servicing Questions & Answers.....	682
Operating Notes.....	682

4-Tube "Pee-Wee" T. R. F. Receiver.....	683
Television Students Learn by Making Cathode-Ray Tubes—Part V.....U. A. Sanabria	683
Radio-Craft's Information Bureau.....	684
Build This Simplified, Neon-Type Test Unit .....Kenneth L. Huntley, W8PQP	685
Canada's "Interference Detectives"—Part I.....	686
"Learn-by-Experimenting" Beginners' Practical Radio Course—Experiment No. 5B.....Sol D. Prenskey	686
The Latest Radio Equipment.....	689
<b>RADIO SERVICE DATA SHEETS:</b>	
No. 223—RCA Model 15U Radio-Phonograph.....	690
No. 224—Ditto (continuation).....	691
No. 225—Ditto (continuation).....	693
Readers' Department .....	692
A "Handy" P.A. Amplifier.....George Davejan	694
Radio Wittiquiz.....	694
Book Reviews .....	704
Radio Interference Now International Problem.....	714

**IN MAY RADIO-CRAFT—  
ANNUAL PUBLIC-ADDRESS NUMBER**

New developments in public address, sound recording, installations and servicing, and other activities of importance to the sound specialist will receive special consideration in the forthcoming issue. Other articles scheduled for this issue are of exceptional interest to radio Service Men, electronic specialists, radio set builders and experimenters.

Ask your newsdealer to reserve for you a copy of the forthcoming May issue (Annual PUBLIC-ADDRESS NUMBER) of *Radio-Craft*.

Published by Radcraft Publications, Inc. Publication office: 29 Worthington Street, Springfield, Mass. Editorial and Advertising Offices: 99 Hudson Street, New York City. Chicago Advertising Office: RADIO-CRAFT, 520 North Michigan Avenue, Chicago, Ill.

Foreign Agents:  
 London—Garringe's American News Agency, 9A Green St., Leicester Square, W. C. 2, England.  
 Paris—Messageries Dawson, 4 Rue Faubourg, Poissonniere, France.  
 Melbourne—McGill's Agency, 179 Elizabeth St., Australia.  
 Dunedin—James Johnston, Ltd., New Zealand.

RADIO-CRAFT is published monthly, on the first of the month preceding that of date; subscription price is \$2.50 per year in U. S. and Canada. (In foreign countries, \$3.00 a year to cover additional postage.) Entered at the post office at Springfield as second-class matter under the act of March 3, 1879.

Text and illustrations of this magazine are copyright and must not be reproduced without permission of the copyright owners.

Copyright 1938 Radcraft Publications, Inc.

# TRAIN FOR RADIO IN 12 WEEKS

## BY MY QUICK, EASY "LEARN BY DOING" METHOD



Prepare today to enter a real money-making field by my quick, easy way to learn Radio. Here in my school you are trained in **12 weeks** for your start for a better job and a real future. You do actual work on a great outlay of Radio equipment. The remarkable "**Learn-By-Doing**" methods used in the great Coyne Shops train you in **Radio, Television** and sound equipment servicing. Not by books . . . Not by Correspondence . . . But all under the individual guidance of skilled instructors, and only on similar kind of work you will meet out on a real job. My methods make it **easy to learn**—First you are **told how to do a thing**—then you are **shown how to do it**—then you **do the work yourself**. WHERE ELSE CAN YOU FIND SO QUICK AND EASY A WAY TO GET PRACTICAL TRAINING IN THIS GIANT INDUSTRY?

# I'LL FINANCE YOUR TRAINING

**DON'T LET LACK OF MONEY** keep you from sending in the Coupon TODAY. Learn how you can get training first and take more than a year to pay for it after graduation. Make your first payment 60 days after your regular 12 weeks' training period ends. Then take over a year to pay the balance of your tuition in easy monthly payments. Hundreds of ambitious fellows have used this method to get Coyne Training. **FILL IN THE COUPON AND MAIL IT TODAY.** It will bring you the details of this amazingly quick and easy way to get your start towards a good pay job.



*H. C. Lewis*

### Radio—Television—Sound Equipment

Your training at Coyne is in wonderful, modern daylight shops on the finest kind of **RADIO, TELEVISION and SOUND EQUIPMENT**. Television is sure to come as a commercial industry, whether this year or next. Talking Picture and Public Address Systems offer opportunities for the trained man. Everything possible has been done to make your stay at Coyne happy and healthful as well as profitable.

### Electric Refrigeration Training Included at No Extra Cost

This combination Training (Radio and Refrigeration) can be of great value to you. Whether you go into business for yourself or get a job working for a Radio Sales and Service organization, the fact that you are trained in servicing Electric Refrigerators should be profitable to you. Many Radio Manufacturers also make Electric Refrigerators and men with this combination training are much more valuable to these employers. You can NOW get this training without extra cost.

### No Advanced Education or Previous Experience Needed

If you can read and write simple English and are ambitious you can be trained the Coyne way—by actual experience on a wide variety of up-to-date Superheterodyne sets, oscillators, analyzers, and test instruments. You learn how to operate television receiving and transmitting equipment and how to install, test and service public address systems and sound picture equipment. Coyne training also helps prepare you to qualify for a government license examination as Amateur Broadcast or Telegraph Radio Operator and to know Code and Department of Commerce rules. Send coupon for all details.

### Part Time Work While Learning Employment Service after Graduation

If you need part time work to help pay living expenses while training, my Employment Department will help you get it. They will also give you Life-time Employment Service after you graduate.

### Mail Coupon Today I'll Send You All the Facts

Get the new "**Coyne Opportunity Catalog**," giving all facts about Coyne Training. Photographs of Shops showing students at work on modern radio equipment under the personal supervision of Coyne Expert Instructors. Also details of my Part Time Employment Offer, Pay After Graduation Plan and Graduate Employment Service. Yours without cost. Simply Mail the Coupon.



**H. C. LEWIS, President** RADIO DIVISION Founded 1899  
**COYNE ELECTRICAL SCHOOL**  
 500 S. Paulina St., Dept. 48-8H Chicago, Ill.

**H. C. LEWIS, President,**  
 Radio Division, Coyne Electrical School,  
 500 S. Paulina St., Dept. 48-8H, Chicago, Ill.

Send me your big FREE Book about Coyne Training and give me all details regarding your "Part Time Employment Offer" and "Pay After Graduation Plan" of easy, monthly payments.

NAME.....AGE.....

ADDRESS.....

CITY.....STATE.....

Please Say That You Saw It in RADIO-CRAFT

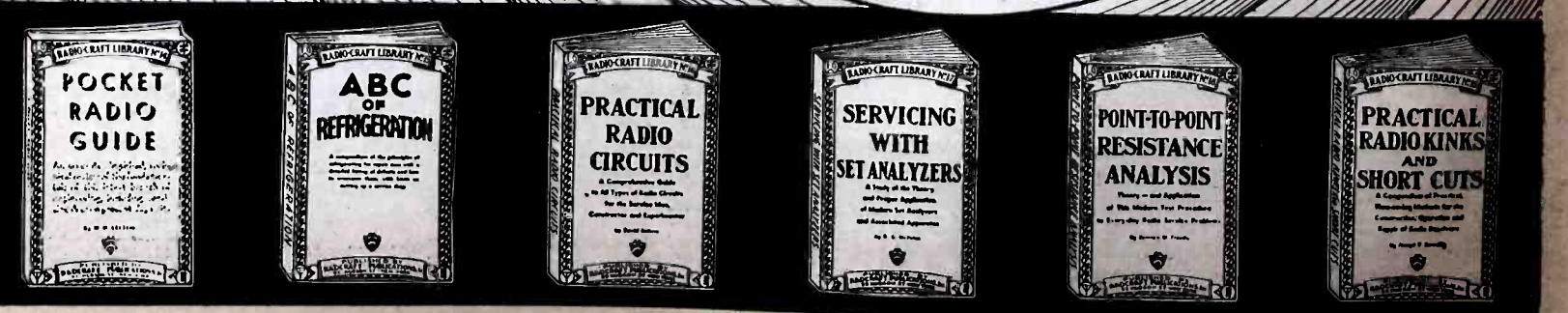
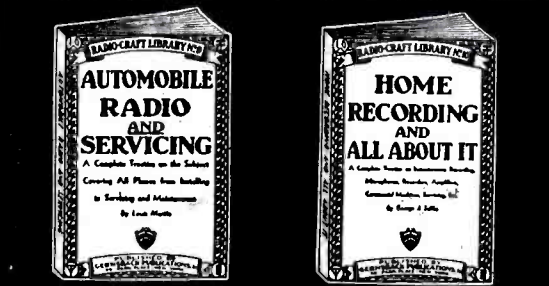
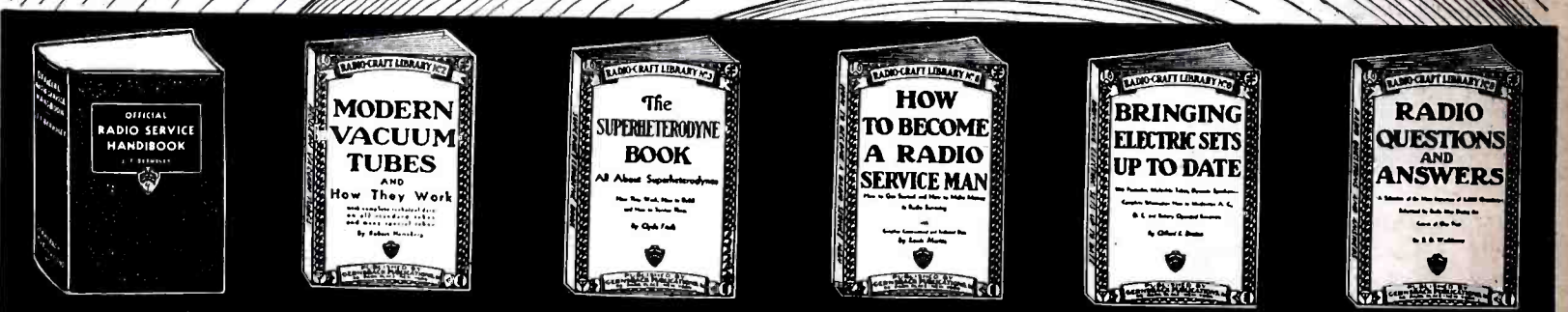
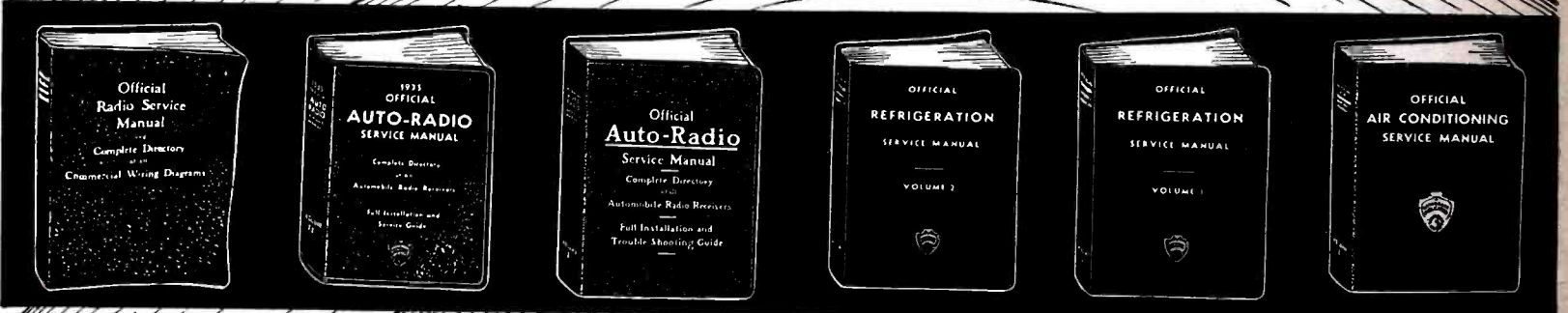
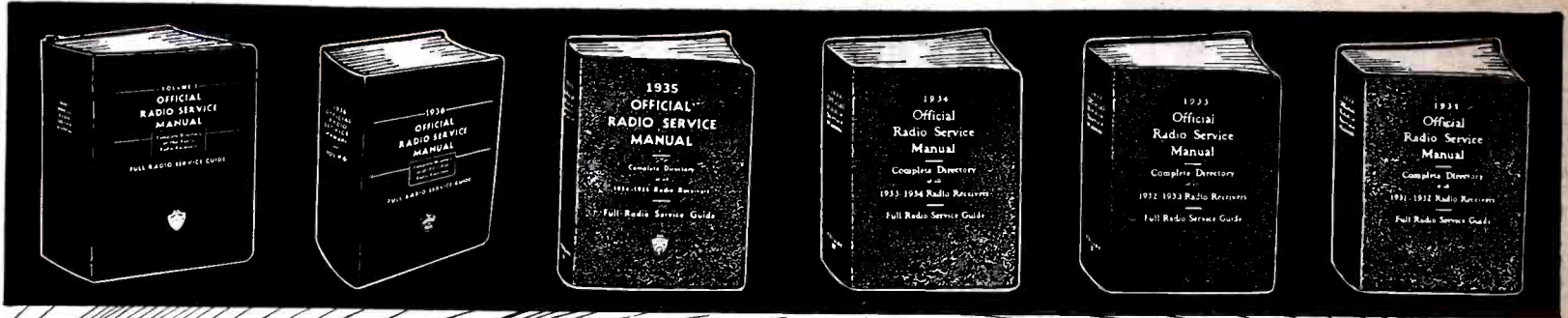

**KNOWLEDGE—  
AT A PRICE !**

Here is knowledge which strains neither the purse nor the mind! Easily digestible, simply written, completely illustrated with photographs and explanatory diagrams . . . yet entirely authoritative and complete in scope . . . that is what we offer in this library of books! Practically every phase and subject connected with radio and its allied fields of refrigeration and air conditioning is covered.

The experience and insight which comes only with many years of publishing radio magazines, books and other literature (we started in 1908) is inevitably reflected in the contents and style of these books. Undeniable proof of these facts is the excellent reputation and popularity which they have achieved. Not too technical, yet technical enough to be authoritative . . . not too expensive so that anyone at all interested in radio can have access to them. Ranging in price from 50c to \$12, every serviceman, experimenter and radio fan can become the proud owner of these books, if not at once, then in easy stages.

Your local dealer and mail order house carries a complete stock of these books. See him today for further information or drop us a post card.

**RADCRAFT PUBLICATIONS, INC.  
99 HUDSON STREET  
NEW YORK, NEW YORK**

Please Say That You Saw It in RADIO-CRAFT



"Takes the Resistance out of Radio"

Editorial Offices: 99 Hudson St., New York, N. Y.

HUGO GERNSBACK, Editor

Vol. IX, No. 10, April, 1938

## ELECTRONIC WONDERS

An Editorial by HUGO GERNSBACK

**P**RACTICALLY all electronic devices which should come under this heading are those which generate within themselves an electronic stream which puts electrons to work in one way or another.

For this reason, strictly speaking, such devices are really tubes of one kind or another. We thus have radio tubes, photoelectric cells, television tubes and multiplier tubes, all of which make use of actual electrons within the tube. Of course a host of other devices erroneously called "electronic" are coupled with these tubes in order to produce the effect desired. Thus, a radio vacuum tube is not of much use by itself unless we use inductances, condensers, resistors and other components, in order to operate our radio sets. But if it were not for the radio tube and its electronic stream, we would not have radio. The same is true of photoelectric cells, television tubes, etc., but the key to all electronic activity is always such an electronic generator, regardless of what we call it or how it is shaped.

It is often said, and quite truthfully, that the electron tube will probably be the one agency which will revolutionize most of our human activities during the next two generations. As yet, we are still considerably in the dark as to the true functioning of electronic tubes. While we have certain theories, a great deal of research remains to be done to give us a better insight into their actual electronic action. The general workings of electronic tubes are known to us and we have a fairly good picture of what goes on, but many new discoveries are being made constantly to make our tubes ever more efficient and sensitive, although such improvements have resulted in more complicated structures of the tube elements.

Considering the improvements and refinements that have been made since the time Edison discovered the famous *Edison effect* in an electron tube, and which have taken years to accomplish, the present-day stage of development gives a rough approximation of what will be done in the future. In radio tubes for instance, continued research has made it possible to use less and less filament current and yet increase the electron output. It is possible today to operate tubes efficiently with the filaments (or heaters) just barely red. This then brings us to the stage of development where filaments will be dispensed with entirely. At the present time, the filament or heater is necessary to generate electrons, but the day is not far distant when filaments and heaters will not be required at all. In other words, we will have absolutely cold tubes that will give us an electron output much greater than any we know of today.

Electrons are not dependent on large amounts of physical heat at all. If we rub a stick of sealing wax with a piece of felt, we generate a huge charge of electrons. The ordinary drycell or battery is also a generator of an electron charge where no heat is used. Then we also have such powerful and natural electron-charge generators as radium, uranium and other elements which constantly give off streams of electrons with no outside heat whatsoever being used. So far, no satisfactory electron tube has been evolved where a heating element in one form or another is not used, but this does not mean to say that we will not have the "cold tube" in the future.

The advent of such "cold tubes" will immediately revolutionize the entire radio industry and by that time the power required to operate a radio set will be infinitesimal compared to the power needed today. It is quite possible that future electronic tubes of this "cold" type will probably be "voltage operated." In other words, minute values of current at high tension will be sufficient to create a stream of electrons, in connection with some other device within the tube. This will make the operation of radio sets and other devices highly economical and efficient.

It is usually the heating effect in modern vacuum tubes such as television tubes, photoelectric cells, etc., which necessitate the comparatively large dimensions and cut down the useful life of these tubes. The heaters give off a billion-fold greater electron stream than is actually required and this surplus stream of electrons raises havoc within the tube, not only by blackening and making the inside surface of the glass conductive, but by changing the vacuum in the tube continuously until it becomes what X-ray technicians call a "hard" tube, meaning thereby that the vacuum has increased beyond the required, normal amount.

During the latter part of January of this year, the entire world was treated to one of the most magnificent electronic spectacles man could ever witness. I refer of course to the *Aurora Borealis* or Northern Lights which flared up over the northern part of the globe because of the electronic bombardment of the earth by the sun on which appeared tremendous sunspots. Remember, that the electrons traveled 93 million miles through an almost perfect vacuum in order to reach the earth, and yet they caused such marvelous effects. It also shows how little we really know of the practical utilization of electrons that have as yet not been harnessed.

Sooner or later we will learn how to tap this tremendous solar electronic emission, a power so vast that if we knew how to harness it, a small fraction of the energy would be sufficient to drive all our machinery, railroads and light up our homes, factories and offices throughout the entire world.

# THE RADIO MONTH



(Photo—Radio Press Service)

Fig. A shows how two 5-meter transceivers were used to communicate between ship and shore while filming an Australian feature. At top, transmitting from camera stand; below, receiving message on boat.

## SUN SPOTS AND STATIC

IN January, the sun came down with a bad case of spots, visible to the naked eye. These resulted in magnetic storms, a lovely Aurora Borealis and gobs of static, the latter audible to the naked ear.

To view the spots, one peered at the sun through heavily smoked glasses. The spot, when seen, was disappointing, and would have gotten nowhere in the Crossley reports; Hollywood could have done it better. It merely looked as though the sun were a trifle mildewed.

The Aurora was much better done. As the magnetic storms swept through the stratosphere, gases at that level glowed like mammoth neon signs, breaking the hearts of sponsors because they did not advertise anything.

The static was a complete success,

for it disrupted short-wave communications as though it were putting its whole soul into the job.

## PROPAGANDA FOR PROPER GEESE

EVERY nation in the world has its own political, social and economic philosophy. Like gossipy old women, nothing suffices the world's nations but to convert other nations to their way of thinking.

Radio is of great service along these lines, and a continuous bombardment of propaganda hurtles through the cringing ether to assault the ears of various nationals and internationals.

Italy has been disseminating anti-British broadcasts of such nature as to provoke Lieut. Comdr. Fletcher to remark, "Italy . . . has now become the poison pen of Europe, and poisons the whole of the world of international relations."

Britain, keeping her other cheek unturned, announced plans to strike back, with counter-propaganda programs in Arabic, Spanish and Portuguese. One such series, aimed at listeners to Italian broadcasts directed at Jerusalem, is given by an Arab prince, son of the King of Yemen.

Japan broadcasts attacks upon the militaristic Chinese Communists; Russia assails Hitler and Mussolini in language which would set fire to a cake of ice; Italy justifies its conquest of Ethiopia and assails Moscow; Germany fires verbal shots at Stalin, which are heard 'round the world, and coyly snuggles up to German-Americans; et cetera.

America, off to a late start, is putting her best foot forward, with some dozen privately-owned high-power short-wave

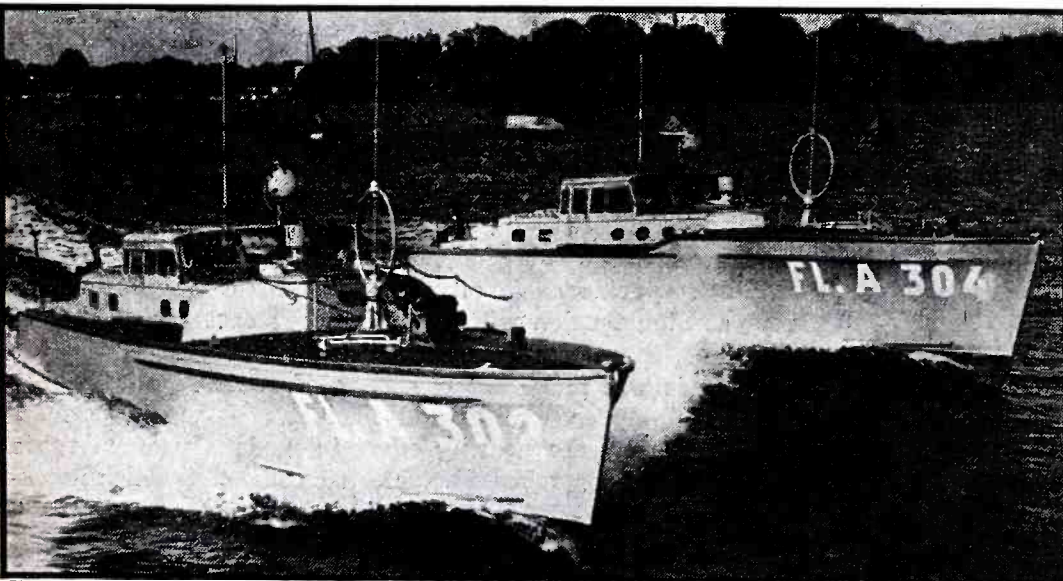
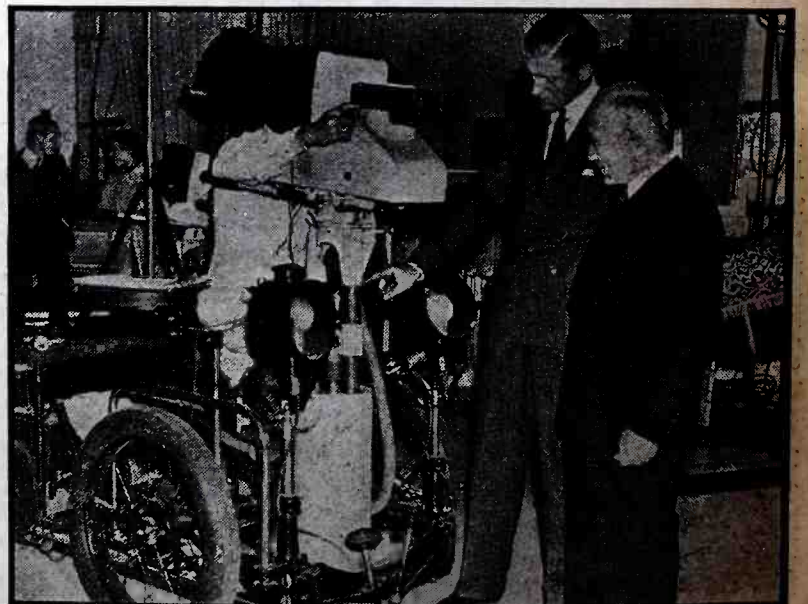

Fig. B—Germany's FL.A. (fur Flug Abwehr) boats, for air defense, have powerful motors and radio direction-finders. As scouts, they will radio an alarm of an invading fleet, then speed to safety.



(Photo—G. E. Co.)

Fig. C—The graph on the "Lie Detector" at the right shows that Grover Whalen is imperfectly truthful. Seeking new equipment for the N. Y. Fair, he tested the instrument, which tripped him twice.



(Photo—Globe)

Fig. D—Adolph Zukor, Paramount Pictures head, inspects the Emitron television pick-up at Alexandra Palace, site of a British studio. The new device is being explained by Gerald Cook, his host.



# IN REVIEW

Radio is now such a vast and diversified art it becomes necessary to make a general survey of important monthly developments. RADIO-CRAFT analyzes these developments and here presents them in review.

stations doing their best to spread the American idea to this naughty world. Unlike most of the foreign programs, those sent from the United States are of the "good will" type, designed to foster international amity rather than to attack any nation or national leader. Most of our directional broadcasts are aimed at our Latin-American neighbors; for example, of the two new aerials at W8XK, Saxonburg, Pa., one is beamed directly on Buenos Aires for Brazil, Argentina and the other South and Central American countries, the other on London, to cover England and continental Europe.

A new G.E. station is being readied on our Pacific coast, for regular broadcasts to the Orient. Many such programs will be announced in Chinese and Japanese, and it is believed that some people who speak and understand these languages will have survived to hear them.

## RADIOFFICIAL REPERCUSSIONS

**M**AE WEST'S original interpretation of Eve, as portrayed in a Sunday night broadcast, may go down in history with even more of a bang than the first flareback indicated. The furrvoiced movie star spoke lines which many found offensive, many inoffensive, many mildly amusing and a few tiresome.

Those who came under the first category grew vocal; protested violently. As a consequence, the program broadcast an apology the following week; the network barred Miss West and all mention of her name from its waves. (Broadcasters may say "damn"—they may not say "Mae West". Isn't radio wonderful?)

In the meantime, F.C. Commissioner McNinch had written N.B.C. prexy Lohr

a letter demanding full information as to responsibility for the broadcast, mentioning that "obscene, indecent, or profane" language on the air was against the law. The fact that stations operate under Federal licensing provisions was also mentioned.

When transcriptions were supplied the Commission, its verdict was that the broadcast was "far below even the minimum standards", and that the "incident" would be considered when license renewal applications were filed.

Had the matter ended there, all would be pretty good, but on January 15, three sequels reached the press:— (1) that Sen. Herring, of Idaho, was preparing a bill to "clean up radio" (i.e., censor it); (2) that the F.C.C. was planning "to raise the moral standard" of radio, and cocked a cocked eye at crime dramas. While it has no power to censor programs, it can exercise a strong hand through its licensing power; (3) that a motion was placed before the Massachusetts state legislature for local control of intrastate broadcasting. No mention was made of what would

(Continued on page 696)

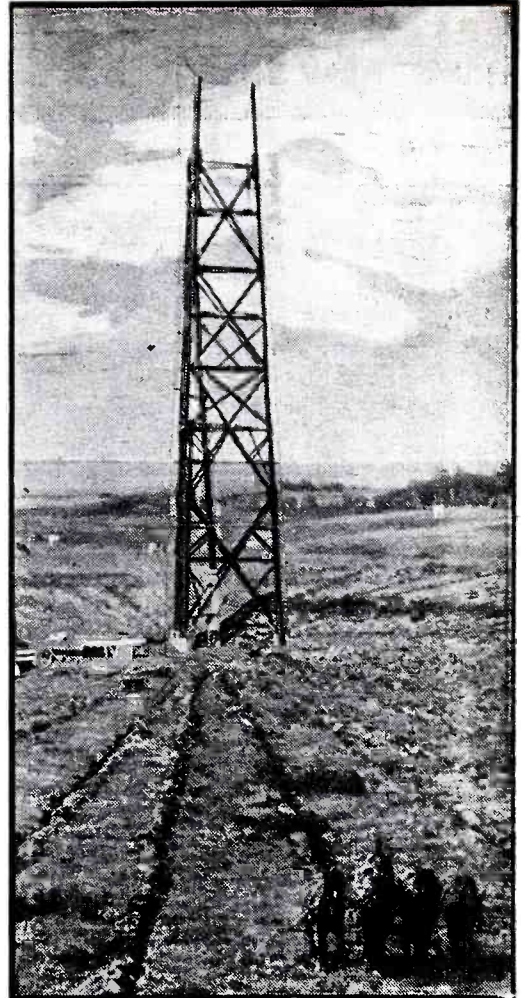

(Photo—RCA)  
Fig. E is a study in contrasts, as the old, horse-drawn plough breaks the earth for the new ground system for CKCK, Regina, Saskatchewan, Canada.

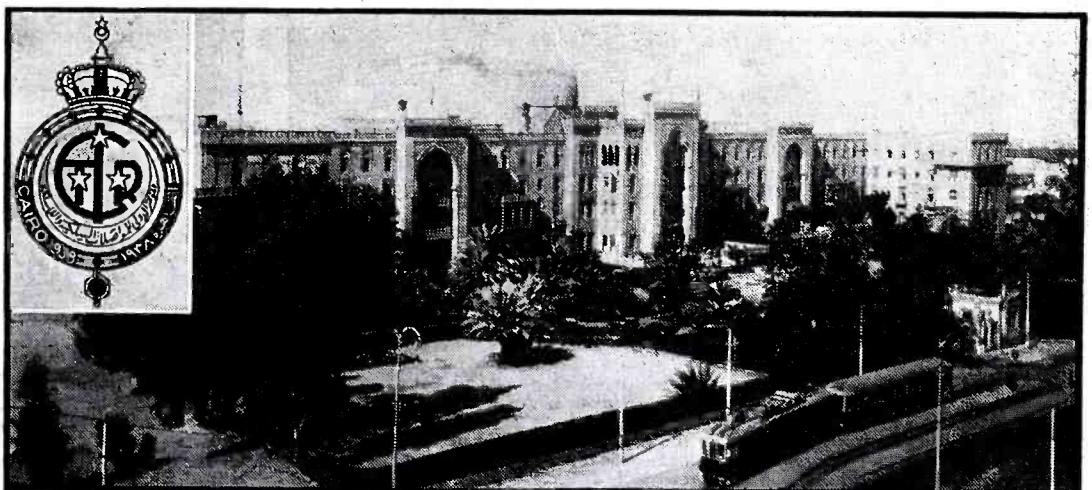

(Photo—Radio Press Service)  
Fig. F—Heliopolis Palace Hotel, Cairo, Egypt, is the site of International Radio Conference, which some 500 delegates of all nations attend every 6 years. Inset, official seal of the conference. (The United States government appropriated \$48,000 to pay the expenses of America's 1938 delegation.)



(Photo—Webster Co.)

Fig. H—Webster mobile speaker equipment in the trailer of Father Sullivan, Catholic Mission, Hingan Fu, Shensi Province, brings religious solace to war-torn China. Father Sullivan is at the mike.

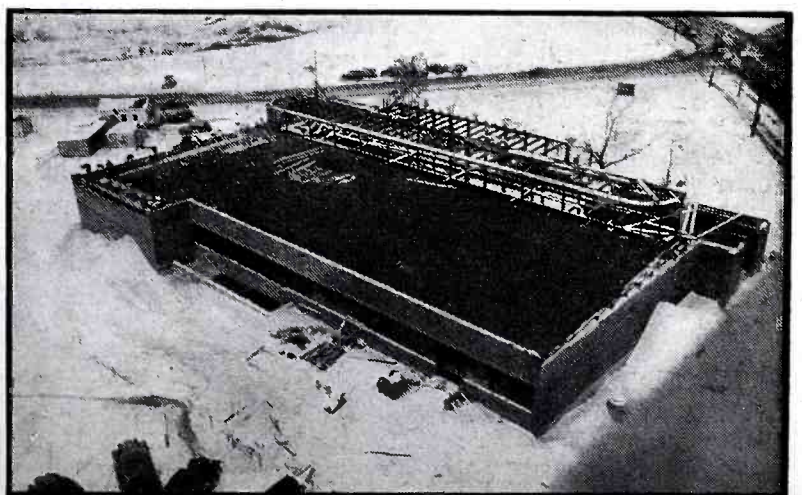

(Photo—G. E. Co.)

Fig. G—The welded steel framework of WGY's new station at Schenectady, N. Y., is practically completed. Most of the walls are up. The station should be ready for occupancy on or about May 1.

# RECENT DEVELOPMENTS



Fig. A. The *Electronica*, an electronic harmonica, provides the tones of a giant pipe organ. Of course, the harmonica's frequency range is limited.



Fig. B. The *Everett Organon*, described elsewhere in this issue, a commercial electronic instrument. (The *Everett* instrument, like the *Hammond organ*, is in the \$1,000 class; the piano, Fig. C, a little under \$1,000; and devices like the *Electar*, Fig. D, \$150, up.)



Fig. C. Ten times the volume of an ordinary concert piano is obtained without use of sounding-board.

Benjamin F. Miessner for 25 years an outstanding inventor and pioneer in radio, has spent the past 7 years (and \$150,000) on the application of electronics to musical instruments. He is considered the greatest living authority on this subject. The *Hammond Organ*, *Everett Organon* and other electronic musical instruments are manufactured under patent license from him. Of his more than 100 patents in kindred arts, 35 deal with electronic music. Some of his earlier patents include radio control of torpedoes, the "cat's-whisker" as used in crystal detectors, the electric radio set for battery elimination, and some 60 others which were sold to RCA in 1930. He also pioneered in electrical recording, which he developed in 1920 for the *Brunswick Phonograph Co.* which supplied the needed element to help restore "disc" prosperity.

**E**LECTRONIC MUSIC now so rapidly coming to the fore is in truth not a very new idea. While the results we see and hear today seem to the layman to be startlingly new, the principles by which these results are secured are rather old.

## ELECTRONIC-MUSIC PIONEERS

For example, in 1885, E. Lorenz of Germany made a dozen electric buzzers vibrate at frequencies of an octave of the musical scale. He did not stop there with the direct acoustic tones so produced; he mounted these buzzers in an evacuated chamber, fed the interrupted currents to a reproducing telephone. The buzzers, therefore, acted as separate sources of musical tone currents which, when controlled by keyboard switches, could be used to produce music by electrical means!

Later Duddell, an Englishman, demonstrated his *talking and singing arc*. This also produced the musical scale of tones when tuned circuits, having natural periods of electrical vibration equal to those of the musical scale, were connected by key switches across the arc circuit.

Thaddeus Cahill, beginning about 1895, developed a very pretentious electrical organ called the *Telharmonium*. This apparatus was actually set up in New York to broadcast, over telephone wires, the musical tone currents it generated. Since amplifiers were then not available, and since Cahill wished to supply innumerable locations with

his electrically-generated organ music, he had to use powerful generators. His apparatus actually required 30 freight cars for its transport and, when set up, looked like a central power plant.

All of these plans came to naught. They were proposed at too early a time, when all the aids and advances of modern electronics were for the most part unknown.

Through the intervening years there have been a great many developments in this art, and these have gradually evolved into the modern electronic musical instruments of today. It is not possible, short of a rather large book, even to review these many interesting attempts at musical tone production by electrical means. Indeed, many of them have already been reviewed in the pages of *Radio-Craft* and other technical periodicals.

*But dozens of instruments, which have passed through all the evolutionary stages, are now on the market and are swiftly coming into use.*

## MODERN ELECTRONIC MUSICAL INSTRUMENTS—ORGANS

One of these utilizes a series of minute inductor alternators, all driven by one induction motor through gearing, to develop the frequencies of the musical scale. Each of these has a number of output circuits so that their particular frequencies can be used in several places simultaneously. That is to say, a given frequency may be used as the fundamental or first partial tone



Fig. D. Tiny "microphones" pick up the strings' vibrations, to be amplified and reproduced.



Fig. E. The soft music of the violin is electronically augmented to fill a mammoth auditorium.

# IN ELECTRONIC MUSIC

BENJAMIN F. MIESSNER

The production of music by electronic means, though a 50-year-old study, is but now approaching perfection. In this article, the leading proponent discusses this new and growing art—Electronic Music.

of one pitch of the scale and also for the 2nd or 3rd or 4th, etc., of other lower fundamental frequency pitches of the scale. In this instrument as many as 8 separate partials may be used, and in any desired amplitude ratios for producing synthetically a great variety of musical tone qualities. The keyboard keys have multipolar switches beneath them, each one of which serves for a particular partial. Pre-set or manually adjustable stops permit the operator to mix these partials together in the amplitude ratios required for particular tone qualities; an amplifier and loudspeaker complete the arrangement.

In another electronic organ, tuned reed-organ or *harmonium*, are selectively vibrated by air suction through key-operated air valves. These reeds are each fitted with electrostatic pick-up screws near their free tips; the reeds are supplied with adjustable polarizing voltage and the pick-up screws are connected to the control-grid (input) of a high-gain audio amplifier feeding a loudspeaker. Several ranks of reeds are used, the vibrations of which may be reproduced singly or in various combinations for different tone qualities.

Another commercial type of electronic organ uses a separate audio oscillator tube for each note of the musical scale.

Some of these instruments have 15 or 20 such series of oscillators, each series having its own amplifier and loudspeaker. The separate oscillator-

amplifier-reproducer ranks use somewhat different circuits so that each such outfit produces a different tone quality through its pitch range. This arrangement is much like pipe organ practice, where many ranks of pipes are used, each rank (ordinarily 61 notes) giving a different tone quality. These ranks, as before, may be played singly or in various combinations through electric or pneumatic actions operated by the keyboard keys.

One of the most recent organs in Germany utilizes gas discharge tubes with reactive discharge circuits. From these may be obtained the familiar saw-tooth discharge waveforms, rich in buzzy harmonics; almost pure sine waves may be obtained also.

The chief difficulty with both audio oscillator and neon tube generators is pitch instability. With many hundreds of such oscillators in an organ it becomes almost impossible to keep them in tune. Pipe organs experience some difficulty of this type but to no such degree.

## ELECTRICAL FRETTED INSTRUMENTS—MAGNETIC VS. ELECTROSTATIC PICK-UP

Electrical fretted instruments such as guitars, ukuleles and violins have been on the market for several years and daily grow in popularity. *At least a dozen manufacturers are producing them. Practically every important dance orchestra uses one.*

These instruments use steel strings  
(Continued on page 712)

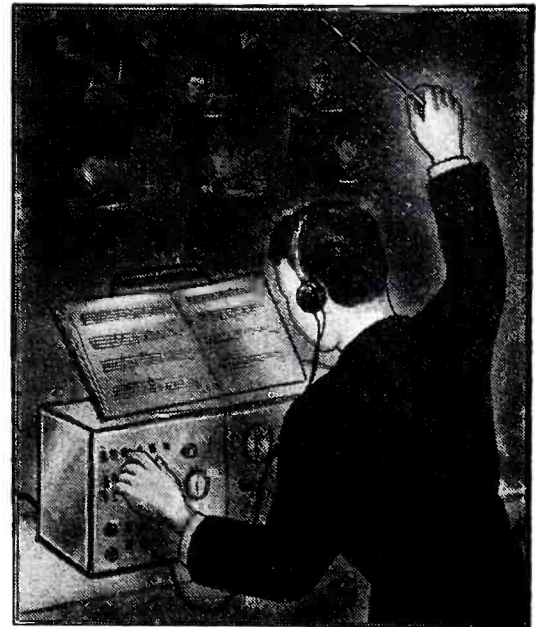

Fig. J. Tomorrow's Toscanini may combine the duties of control man with those of conductor. An earphone enables him to hear an audience-mike's pick-up.

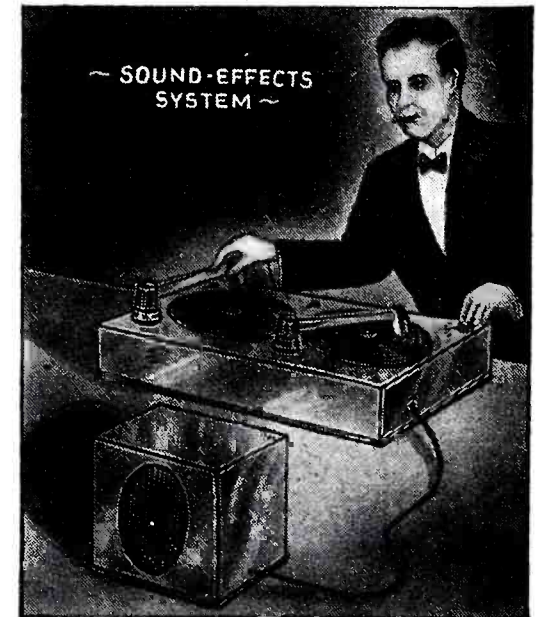

Fig. I. All sound effects, from bird songs to waterfalls are recorded for electronic reproduction. The orchestra of the future, envisioned by Mr. Miessner, will offer heretofore unheard musical effects—plus sound effects. (We'd like to hear the *1812 Overture* with the sounds of battle supplied via discs.)



Fig. F. Not only is the tone improved, but the new "dog-house" (bass viol) is easier to carry, as well.



Fig. G. A felt plug permits the clarinetist's breath to escape, but absorbs the sound waves.

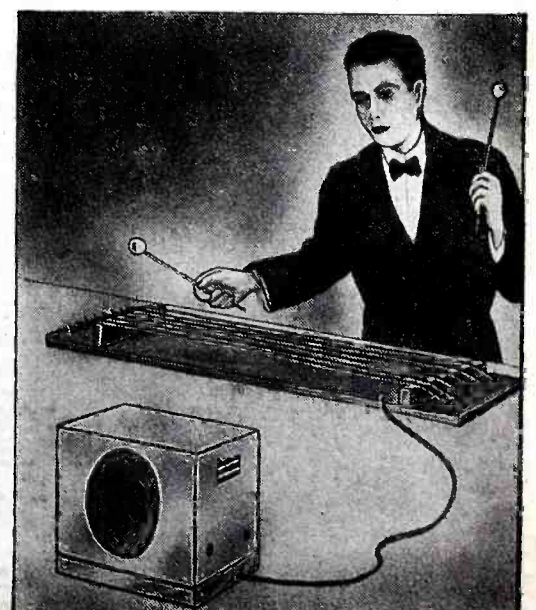

Fig. H. Felted hammers strike stretched gut strings to produce music of kettle drums electronically.



# CIRCUIT FEATURES

## SERVICE INSTRUMENTS

The author of "Radio Physics Course," "Modern Radio Servicing," and other books for Service Men, analyzes modern test circuits. Every technician should familiarize himself with these new developments.

ALFRED A. GHIRARDI

unique 0 to 250-volt D.C. voltage measuring section which draws absolutely no current from the circuit to be measured—and does this without resorting to complicated vacuum-tube voltmeter circuits, etc.

Figure 2A shows a diagram of an elementary circuit which will aid in making the system easily understood. Resistor R1 is an adjustable potentiometer resistor in the analyzer. The voltage drop (E1) across it is applied with the proper polarity (*positive to positive*) so as to "buck" the voltage E2 which is to be measured. A voltmeter V and a "zero-center" galvanometer G are also connected as shown.

The operation is as follows: when the unknown voltage E2 to be checked is applied to terminals A-B of the instrument, either it or the potential E1 across the potentiometer will be the higher. This difference of potential will cause a current to flow through the galvanometer and cause it to indicate. If the voltage E2 to be measured is *higher* than E1, the current flow will be from A around through the galvanometer and circuit to B and will be so indicated on the galvanometer. If the voltage E2 is *lower* than E1, the current will flow in the reverse direction and the galvanometer will so indicate. If the arm of the potentiometer is adjusted so that these two voltages are exactly equal, they will buck and neutralize each other, and no current will flow through the galvanometer. The voltmeter V, will then give an indirect but *exact* reading of the potential E2 across A-B—*without drawing any current from the circuit under measurement* (the current for operating the voltmeter is furnished by the power source connected to R1). In practice, the potentiometer is varied until G shows *no indication*, the unknown voltage is then read on the voltmeter V.

By providing the voltmeter V with several ranges, and also making the voltage E1 variable to cover all these ranges, the system is equally accurate, and presents an infinite resistance to the voltage being measured on all of these ranges. This system (1) draws no current on any range, (2) is unaffected by variations of line voltage and (3) the calibration is not disturbed by changing tubes. In the actual instrument, a simple switching arrangement makes one meter serve as both the galvanometer

and the voltmeter, which is a great convenience in operating it.

In Fig. 2A, a simple battery is shown as the voltage source in order to simplify the diagram. In the actual instrument, however, power for the zero-current voltmeter (as well as for the capacity meter and the highest range of the ohmmeter provided in the analyzer) is obtained from a built-in power supply consisting of a conventional power transformer, rectifier and filter system.

### (3) SMOOTH-CONTROL STEPLESS ATTENUATOR

**Clough-Brengle OCA Oscillator.** The exceptionally smooth control of high radio-frequency output which is provided in this test oscillator is accomplished by the novel attenuator arrangement shown in Fig. 2B.

The variable, non-inductive controls, R2 and R3, are low in resistance value as compared with the series fixed-resistor R1 which connects to the output of the oscillator tube. Impedance changes in R2 and R3, therefore, have a negligible effect on the tuned circuit, maintaining stability and frequency accuracy at a high level.

In normal operation arm A gives a *coarse* adjustment of R.F. output, while arm B acts as a vernier.

On the higher frequencies arm A is moved to the point D, which is maintained at "ground" potential. The only R.F. voltage appearing across R3 then comes from whatever distributed capacity exists between the circuit elements (represented by C1). Adjustment of arm B gives very smooth control of the R.F. output of the oscillator.

### (4) INDEPENDENT HOT-CATHODE LEAKAGE AND INTER-ELEMENT LEAKAGE TESTS

**Radio City Model 306 "Dependable" Tube Tester.** The value of adequate hot-cathode and inter-element leakage tests on modern vacuum tubes is too well known to need explanation here. The use of sensitive neon lamps as visual indicators for these leakage tests has become almost universal practice in the design of tube testers. However, an interesting variation of this arrangement is used in the tube tester considered here.

In this tester a sensitive neon lamp which indicates inter-element leakages

(Continued on page 715)

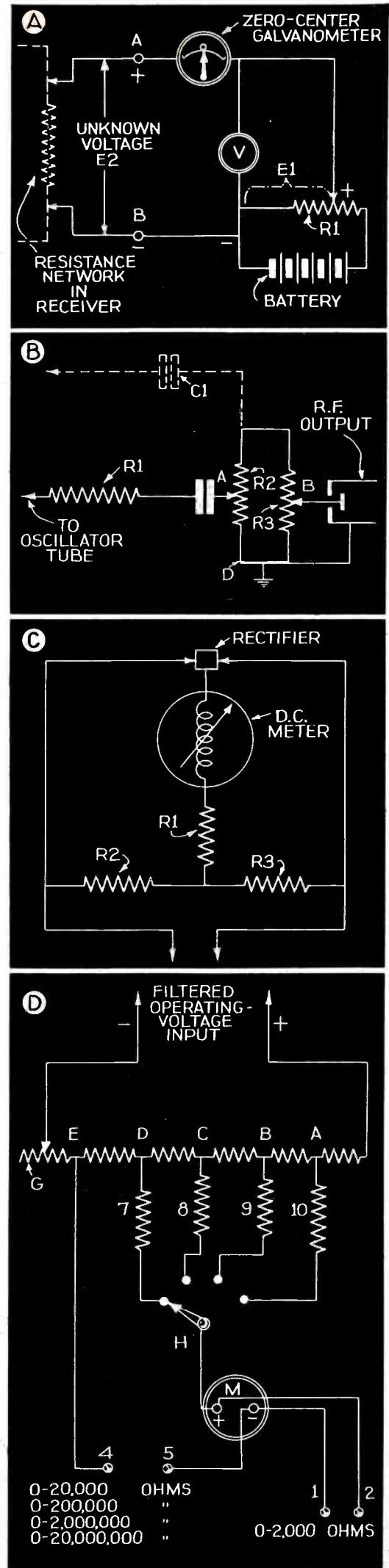

Fig. 2. (A) Good "no-current" potentiometer-type voltmeter circuit. (B) A smooth-control, stepless-attenuator circuit of a modern service oscillator. (C) Temperature compensation circuit for rectifier-type meters. (D) Circuit of calibrated ohmmeter which operates directly from the A.C. line. The rectifier circuit and filter channel are not shown in the above sketch but are very essential elements.

# INDIA'S NEW NETWORK OF RADIO BROADCASTING

A new radio system, with broadcast band and short-wave transmitters and time clock operated, pre-tuned receivers in key villages, furthers India's plan for eventual complete coverage. An unusual feature of this new All-India Radio system is that the pre-tuned receivers are dial-less and padlocked; and that the 8,000-volt power-supply tubes use mica "lampshades" to reduce possibility of "backfire."

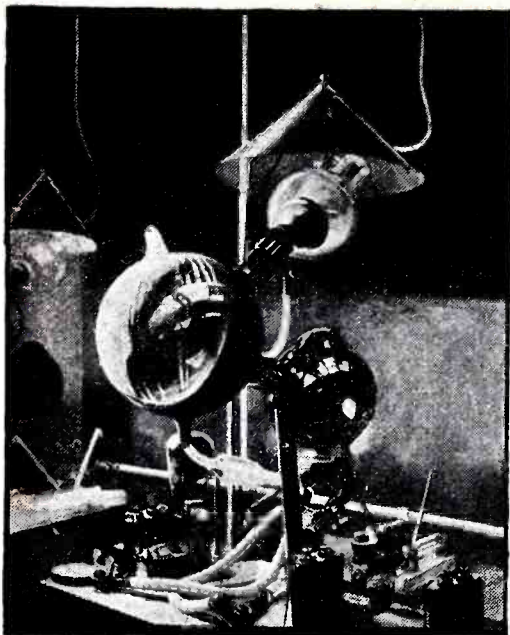

Fig. A. Reproduction of the cover painting showing the 8,000-V. Philips rectifier tube to be used in the new All-India Radio broadcasting network.

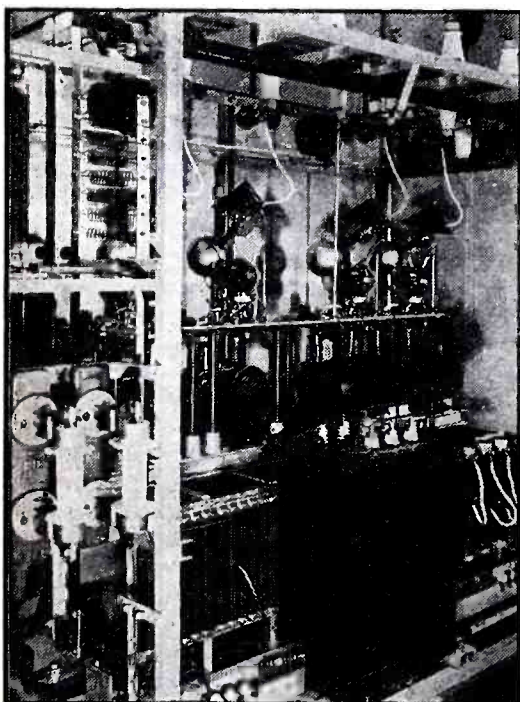

Fig. B. View of some of the power supply equipment for the transmitters. At the right is the bank of four 8,000-V. Philips rectifier tubes.

THE technical problem that now confronts the Broadcasting Department of the Government of India, All-India Radio, is that of providing a service over an area of nearly 2,000,000 square miles with the limited funds available, official announcements state.

In the development of broadcasting in India it has been accepted by All-India Radio as a fundamental precept that a satisfactory broadcasting system must provide a measure of service to the whole country. This immediately determines the principle of operating transmitting stations on the short wavelengths. At the same time, it is admitted that this is not a final solution. Simultaneously with the provision of a short-wave or "second-grade" service to the whole area, a medium-wave or "first-grade" service is necessary for the large towns. The basic principle of broadcasting development in India, therefore, is to provide a short-wave service to the whole country and to support this by a continual expansion of the area served by medium-wave stations as funds become available.

## 10 TRANSMITTERS ORDERED

To this end 10 transmitters have been ordered. Four short-wave "key" stations will be established at Delhi, Bombay, Calcutta, and Madras, and will be of 10-kw. (aerial) power. A second short-wave transmitter of 5-kw. power is also to be provided at Delhi for special purposes. The development program does not envisage any future increase in the number of short-wave stations. These

short-wave stations will provide a "second-grade" service to the whole of India.

At the same time, 5 medium-wave stations have been ordered, and will be situated at Lahore, Lucknow, Trichinopoly, Dacca, and Madras, the first 4 stations having a power of 5 kw. The Madras medium-wave station will have a power of 250 watts, and will service the city only, as Madras will also be provided with a 10-kw. short-wave transmitter. With these stations, and the existing medium-wave stations at Delhi, Bombay, Calcutta, and Peshawar, All-India Radio will have in operation 5 short-wave stations and 9 medium-wave stations. Two of the new stations are expected to be in operation by the end of the year: the 10-kw. short-wave station at Delhi and the 5-kw. medium-wave station at Lahore.

## CHOICE OF SHORT WAVELENGTHS

It is expected that the Indian short-wave stations will normally operate in the daytime on the 30-meter and 49-meter bands and at night principally on the new 60-meter and 90-meter bands for broadcasting which will be proposed at the forthcoming Cairo Conference.

It is considered that there should be no interference between the Indian short-wave stations operating an internal service and the European and the other short-wave stations operating an international service, as the Indian day wavelengths are the European night wavelengths, and the Indian night wavelengths are not used by the (Continued on page 698)

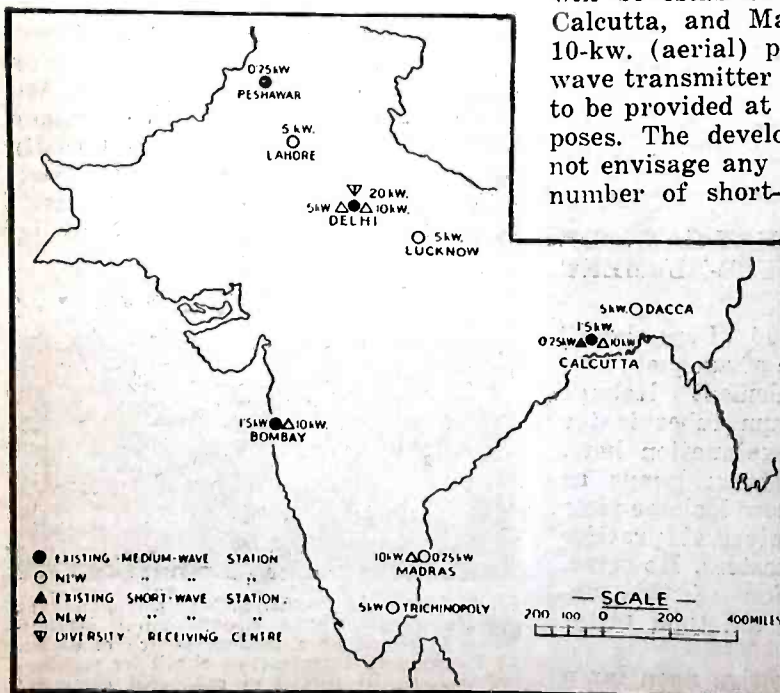

Fig. C. The map of India showing the locations of both the existing and the contemplated short-wave and medium-wave broadcasting stations. Only strategic spots, from the good-reception angle, were chosen.

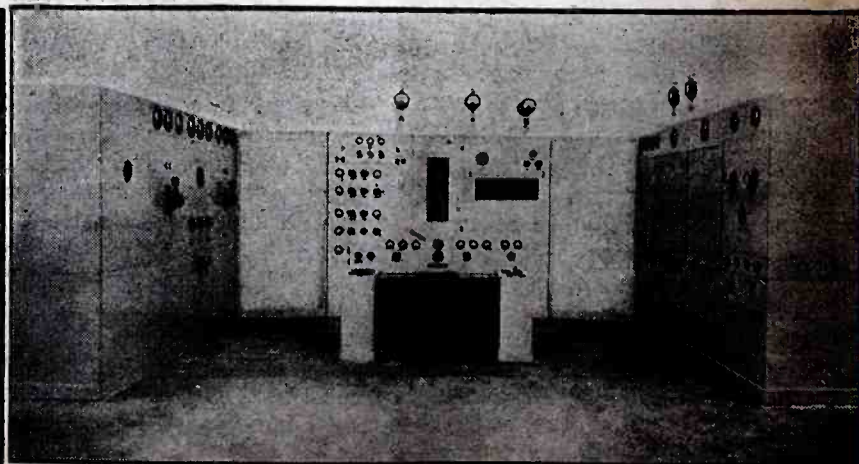

Fig. D. Impressive view of the short-wave transmitters to be used in the new All-India Radio broadcasting system. Other transmitters will operate in the medium-wave band, thus providing day and night broadcasting.

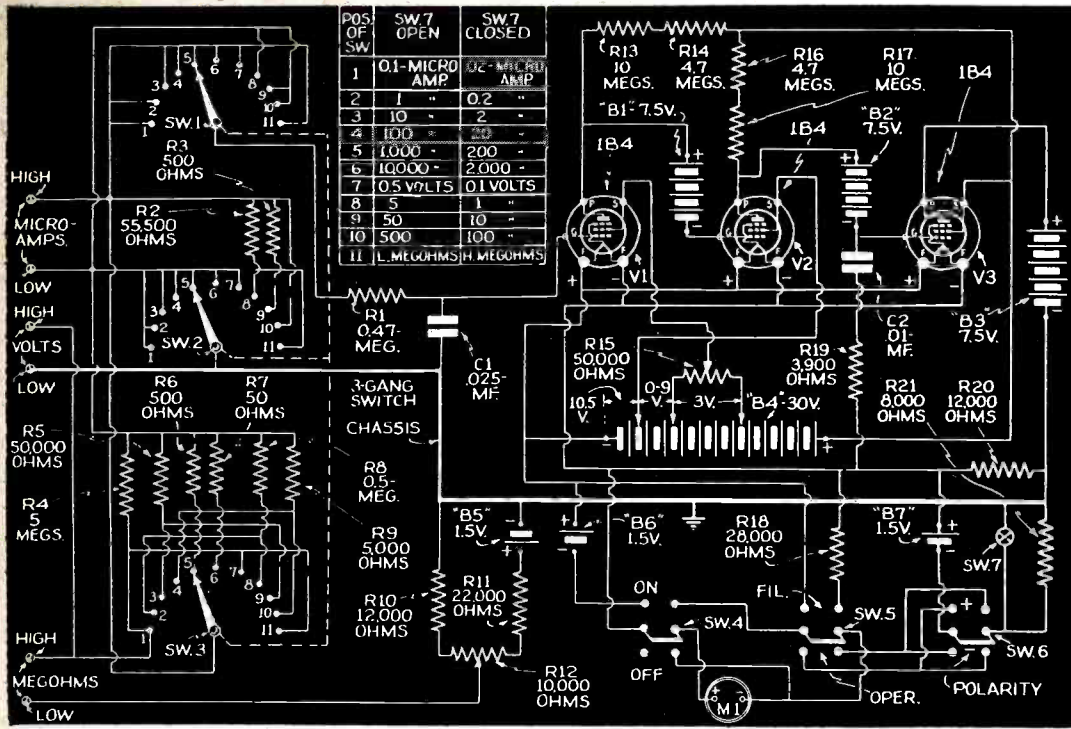

Fig. A. Front view of commercial unit.

A revolutionary new meter, devised by Dr. V. K. Zworykin of RCA electronic research laboratory, has a "negative-feedback" amplifier to gain "galvanometer" sensitivity.

## NEW "AMPLIFIED" D.C. METER

THE ultra-sensitive meter illustrated in Fig. A was developed for accurate measurements of ionic and electronic currents, employing a new electronic circuit which operates with unusual stability and amazing accuracy, even approaching that of the average reflecting galvanometer. For an instrument of its extreme sensitivity it is amazingly rugged. It cannot be easily damaged or burned-out by overload currents.

In current measurements the new meter provides for 12 scale ranges for measurement to 10,000 microamperes, the lowest full scale reading being .02 microamperes. For voltage measurements, 8 other scale ranges are available from .1 volts to 500 volts, with a meter resistance of 5 megohms. For resistance measurements, 2 scale ranges are provided for measurements of from .1 to 100 megohms, and from 20 to 1000

megohms, with less than .05 volts across resistance. With 90 volts in series, up to 200,000 megohms can be measured. Conversion of the meter for the 3 forms of operation is accomplished by means of a selector switch.

The Ultra-Sensitive D.C. Meter is a self-contained, battery operated (see Fig. B) precision instrument, utilizing three type 1B4 tubes. No external resistances or shunts are required.

The overall accuracy for all ranges of current or voltage measurements is plus or minus 2% of full scale at ambient temperatures of 50 to 100° F. and normal humidity. For resistance measurements the maximum deflection error is plus or minus 0.1 inches at mid-scale. This error is less at other points of the scale approaching zero at the ends.

### THEORY OF OPERATION

The Ultra-Sensitive D.C. Meter es-

entially consists of a group of input circuits, a D.C. feed-back amplifier, and an indicating meter. The principle of operation is easily grasped by referring to the block diagram, which shows a D.C. amplifier with its output connected in series with its input. It should be assumed to contain an odd number of stages so as to produce negative feed-back. When such an amplifier is connected in this manner, it will "lock-in" at what may be called its equilibrium condition which represents a certain voltage on each plate and grid in the amplifier (with respect to cathode) and a certain feed-back voltage (developed across  $R_o$ ) returned to the input. The system will tend to hold to these values with a tenacity proportional to the gain "G". Any tendency toward oscillation is prevented by the shunt capacitor. It may be assumed further that the amplifier is internally adjusted so that the equilibrium feed-back voltage is just equal to "E" so that the voltmeter (V.M.) will show no deflection.

(Continued on page 700)

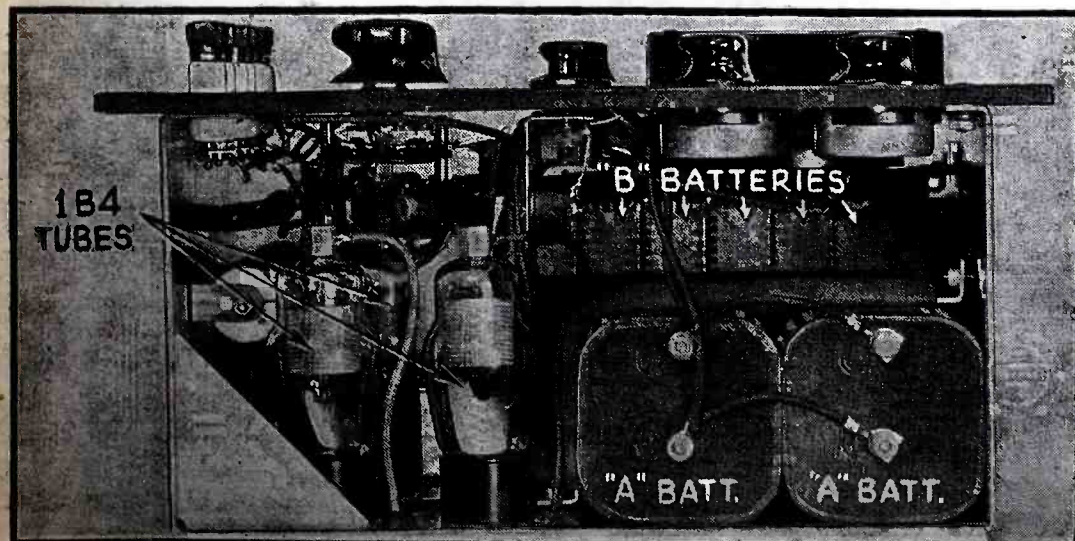
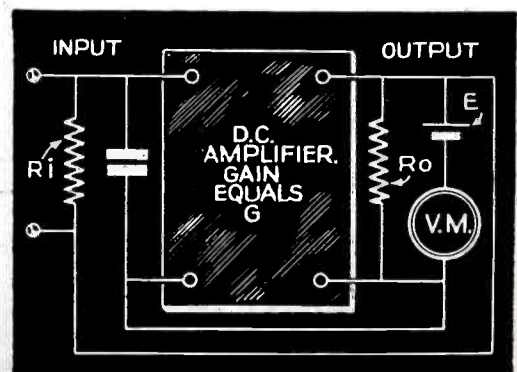

Fig. B. Interior view of meter showing outstanding components.



Block diagram of theory. Equivalent circuit, upper-left, reproduced by special permission.

## HIGHLIGHTS OF THE "BROWNING-83" 4-BAND SUPERHET. RECEIVER

Complete 4-band tuner assembled, wired and prealigned;

4-band range, 0.54- to 22 megacycles;

10 tubes employed, viz: 2-6K7's, 1-6A8, 1-6H6, 1-6F5, 1-6C5, 2-6F6's, 1-80, 1-6G5;

All tuning circuits individually shielded;

Large high-ratio vernier dial, accurately calibrated in megacycles for each band (4 scales on the dial);

Non-critical, straightforward superheterodyne circuit;

High signal-to-noise ratio;

Diode detection;

Automatic volume control;

Resistance-capacity coupled audio channel;

Push-pull 6F6 output with phase inversion;

Triple-tuned I.F. circuits with variable gain controllable from front of panel;

Visual tuning indicator;

High-quality speaker to match receiver.

Succeeding Parts will contain curves, chassis layouts, test voltages, and a picture diagram.

HERE IS THE HIT SET  
OF 1938!

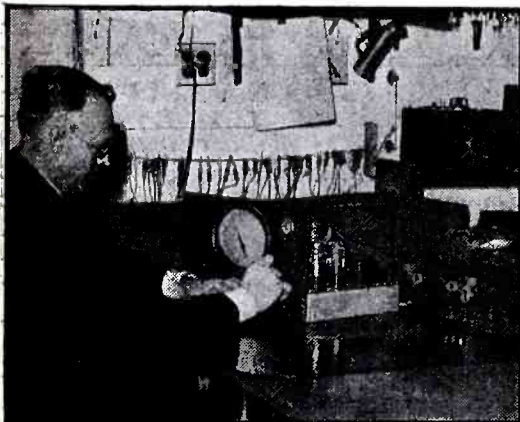

Fig. A. The author, checking the completed receiver which is described in this article.

# IT'S EASY TO BUILD THIS "BROWNING-83" 4-BAND SUPERHET.

GLENN H. BROWNING

THERE are, and always will be, experimenters in all scientific fields for not only is experimenting an interesting hobby but often contributes materially to our scientific knowledge. Many inventions have been made by individuals, especially in the field of radio, independently of commercial interests. The American amateur and experimenter has continually paved the way in the transmission and reception of radio signals ever since the day of wireless and is today exploring new frequency spectrums, new circuits, new antenna arrays and new problems.

The writer, who was an experimenter in the early days of wireless, has always been interested in designing kit receivers for this group. Three years ago, when it was proposed to bring out an all-wave kit receiver, it was predicted that there were relatively few who would consider building such a set. However, the "Browning-35" was so well received and so enthusiastic were the reports on its performance that the writer was encouraged to re-design the kit incorporating new worthwhile features. This re-design was started about 6 months ago and has now been completed.

### DESIGN FEATURES

The new "Browning-83" kit receiver is much more flexible, and thus permits more leeway for experimentation. The heart of the new receiver is an all-wave tuning catacomb embodying the coils,

tuning condensers, padding and trimming condensers for a sharply-tuned antenna stage, a stage of radio-frequency amplification on all bands, and the oscillator circuit for the 4 bands covered. The tuning ranges are changed by means of a band-switch with low contact-resistance which so operates as to short-circuit all coils not actually in use. Three shield compartments are provided, each of which houses a single stage for all bands. The trimming condensers are rigidly mounted on the coils, so that they are easily accessible for alignment purposes and are connected to the coils and switch units with heavy leads, thus insuring permanence in alignment. The band-switch is of the multi-deck type, so that all stages are switched simultaneously by means of a single control. The main 3-gang tuning condenser is mounted on the top of the chassis which houses the coil assemblies, and is completely shielded by means of demountable shields which may be removed easily to provide complete accessibility. Connection is made to the rotor plates by means of heavy braid leads, which connect directly to the low-potential end of the associated coils, rather than through the medium of the tuner chassis. This tends to eliminate chassis currents which might otherwise produce undesirable effects such as degeneration, regeneration, oscillation, etc.

The tuning catacomb, covering a frequency spectrum from 0.54- to 22 mega-

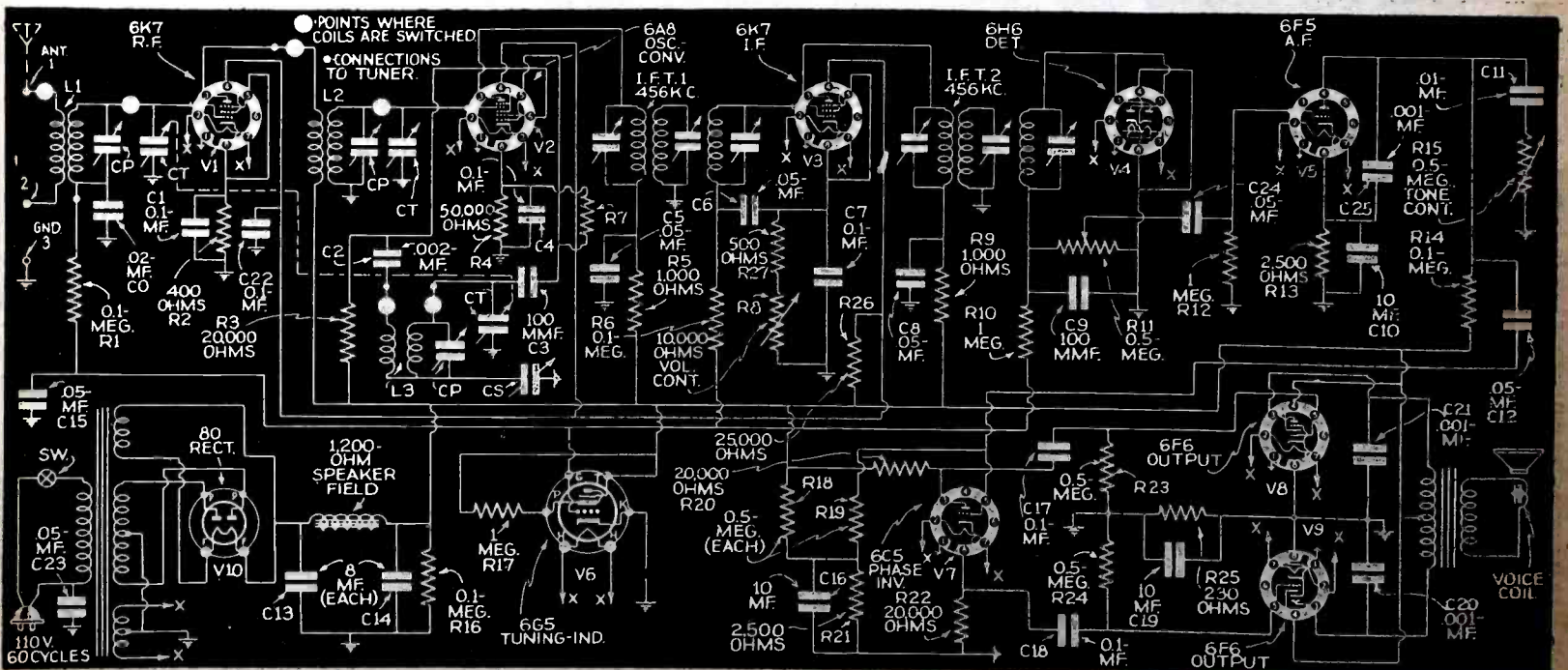

Fig. 1. Only 4 components (the two 20,000-ohm resistors and the two 0.1-mf. condensers in the phase-inversion circuit) are critical. Correct value for R21 is 50,000 ohms and not 2,500 ohms. Correct value for R4 is not 50,000 ohms as shown in diagram above, but, 250 ohms.



The author, a famed designer of kit receivers for the amateur set-builder, surpasses the triumph he achieved in the popular "Browning 35" with this design of the new "Browning 83". Pre-aligned when you obtain it, the essential tuning catacomb covers 4-bands, from 0.54- to 22 megacycles. It has more than ample volume for any ordinary use.

## PART I

cycles, is completely wired, tracked and aligned when you get it. This insures correct tracking and alignment of the various circuits involved and insures a frequency coverage in accordance with the dial calibration. A great deal of work has been done on this tuning catacomb to obtain as high a signal-to-noise ratio as possible. This is accomplished by a careful design of the coils and the elimination of chassis currents. The tuning catacomb is grounded to the main chassis at one point only. This is important. The isolation of the tuning catacomb from the main chassis at the points of mechanical support is accomplished by means of soft-rubber grommets which serve a number of purposes. One of these is the cushioning effect which tends to reduce acoustical vibration in the unit itself; another is to eliminate entirely the possibility of any circulating currents (which may be set up in the main chassis) from entering the tuning assembly; another is to reduce direct conductive heat transfer from the main chassis into the tuning catacomb, thus tending to some extent to reduce oscillator drift.

### EASILY BUILT BY AVERAGE EXPERIMENTER

In the design of a kit receiver, it is desirable that the circuit employed shall be so basic and so straightforward that the set may be easily constructed by the average experimenter. The chassis layout should be such that there is little chance for encountering oscillation and other troubles in the intermediate-frequency amplifier. At the same time the layout should be flexible enough to allow individual experimentation in such circuits as the intermediate-frequency amplifier, the audio-

frequency amplifier and such additional circuits as noise suppression, automatic frequency control, etc. In this kit set, additional space and tube-socket holes have been purposely included. Thus provision has been made for the addition of various circuits which will be presented to the experimenter from time to time.

The basic superheterodyne circuit is shown in Fig. 1 and, as will be noted, employs a sharply-tuned antenna circuit, a stage of radio-frequency amplification on all bands, and an oscillator circuit with a 6A8 tube used as a pentagrid converter. Numerous types of intermediate-frequency amplifiers have been experimented with from the standpoint of ease of construction, selectivity, and high audio fidelity, and it has been found that the triple-tuned band-pass circuit is outstanding.

From the standpoint of the experimenter, the link circuit in the band-pass filter arrangement, which is factory-aligned to the intermediate frequency of 456 kc., acts as a key, as the only connection to this circuit is a ground lead and, consequently, the frequency to which it is tuned is not altered by lead or tube capacity. Thus, this circuit assures that, when the I.F. amplifier is finally aligned, the proper intermediate frequency is obtained. This is very important if the dial calibration of the receiver is to be accurate. Another function of this link circuit is to broaden the nose of the response curve of the intermediate-frequency amplifier, which results in improved audio quality. It would be expected that broadening the nose of the response curve would result in poor overall selectivity; however such

(Continued on page 707)

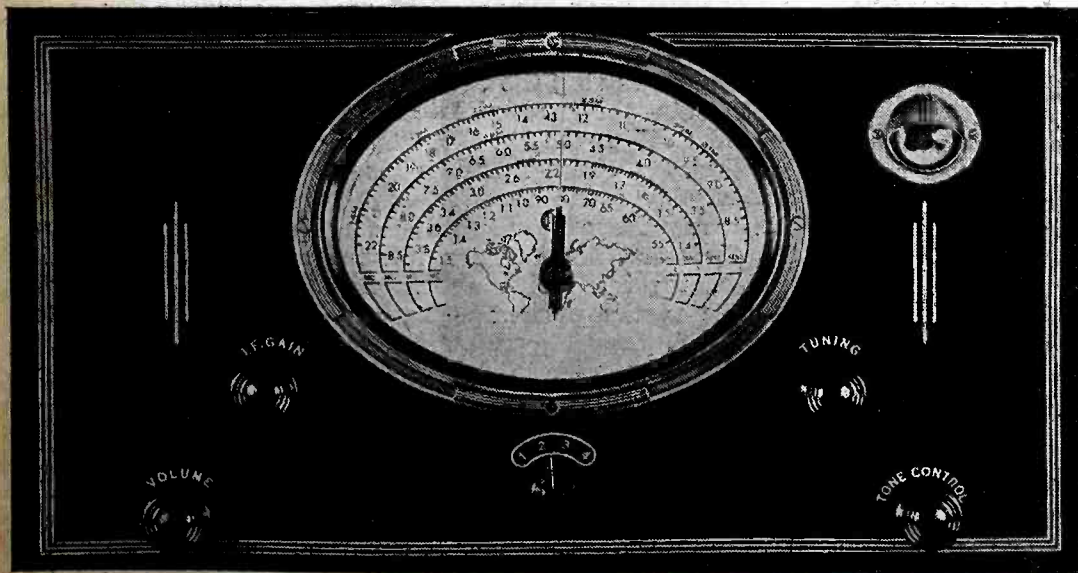

Fig. B. All waves, continuously from 0.55- to 22 megacycles, are available in this kit receiver, which uses 10 tubes, including a phase inverter and a "tuning eye" indicator.

## AT LAST!

Here, Mr. Communications Amateur, is the superhet. you long have wanted. It combines all the essential elements of an efficient 0.54- to 22 megacycles communications receiver, yet employs only the optimum number of tubes.

Here, Mr. Radio Experimenter, is a 13.6 to 555 meter ultra-modern radio set. Its kit-type construction and the use of a factory-made pre-aligned catacomb makes building this set "apple-pie."

### LIST OF PARTS

- One Browning tuner, model No. 1;
- One Browning dial and escutcheon;
- One Browning band-switch escutcheon;
- One Browning bakelite antenna strip;
- One Browning drilled black crinkle panel;
- One Browning drilled cadmium plated chassis;
- One Browning I.F. trans., 456 kc., I.F.T.1;
- One Browning I.F. trans., 456 kc., I.F.T.2;
- Five Browning 7 x 22 in. pictorial wiring diagrams and instructions;
- \*One power and filament transformer with static shield;
- One Browning special etched and engraved panel;
- One I.R.C. resistor, 230 ohms, 2.5 W., R25;
- One I.R.C. resistor, 250 ohms, 0.5-W., R4;
- One I.R.C. resistor, 400 ohms, 0.5-W., R2;
- One I.R.C. resistor, 0.5-W., R27;
- Two I.R.C. resistors, 1000 ohms, 0.5-W., R5, R9;
- Two I.R.C. resistors, 50,000 ohms, 0.5-W., R13, R21;
- One I.R.C. resistor, 20,000 ohms, 0.5-W., R8;
- Two I.R.C. resistors, 20,000 ohms, 0.5-W. (5% tolerance), R20, R22;
- One I.R.C. resistor, 25,000 ohms, 1.0 W., R26;
- One I.R.C. resistor, 50,000 ohms, 0.5-W., R7;
- Three I.R.C. resistors, 0.1-meg., 0.5-W., R1, R6, R14;
- One I.R.C. resistor, 0.1-meg., 1.0-W., R16;
- Four I.R.C. resistors, 0.5-meg., 0.5-W., R18, R19, R23, R24;
- Three I.R.C. resistors 1. meg., 0.5-W., R10, R12, R17;
- \*One paper cond., 0.01-mf., 400 V., C11;
- \*Seven paper condensers, 0.05-mf., 600 V., C5, C6, C8, C12, C15, C23, C24;
- \*Six paper condensers, 0.1-mf., 400 V., C1, C4, C7, C17, C18, C22;
- \*Two tubular electrolytic condensers, with clamp, 475 V. working, 600 V. peak., 8 mf., C13, C14;
- \*Three tubular electrolytic condensers, 50 V. working, 75 V. peak, 10 mf., C10, C16, C19;
- \*One mica condenser, 0.002-mf., C2;
- \*Two mica condensers, 100-mmf., C3, C9;
- \*Three mica condensers, 0.001-mf., C20, C21, C25;
- One Centralab resistor, 500 ohms fixed, 10,000 ohms variable potential, right-hand taper, R8;
- One Centralab variable potential resistor, 0.5-meg., left-hand taper, R11;
- One Centralab variable potential resistor, 0.5-meg., right-hand taper, with A.C. switch, R15;
- One Wright-DeCoster loudspeaker, BL 1100, 1,200-ohm field;
- Two RCA type 6K7 tubes;
- One RCA type 6A8 tube;
- One RCA type 6H6 tube;
- One RCA type 6F5 tube;
- One RCA type 6C5 tube;
- Two RCA type 6F6 tubes;
- One RCA type 80 tube;
- One RCA type 6G5 tube;
- \*Eleven wafer sockets for tubes and loudspeaker;

\*Most Radio mail order houses can supply this item if properly identified as to title of article, issue (month) of Radio-Craft and year.

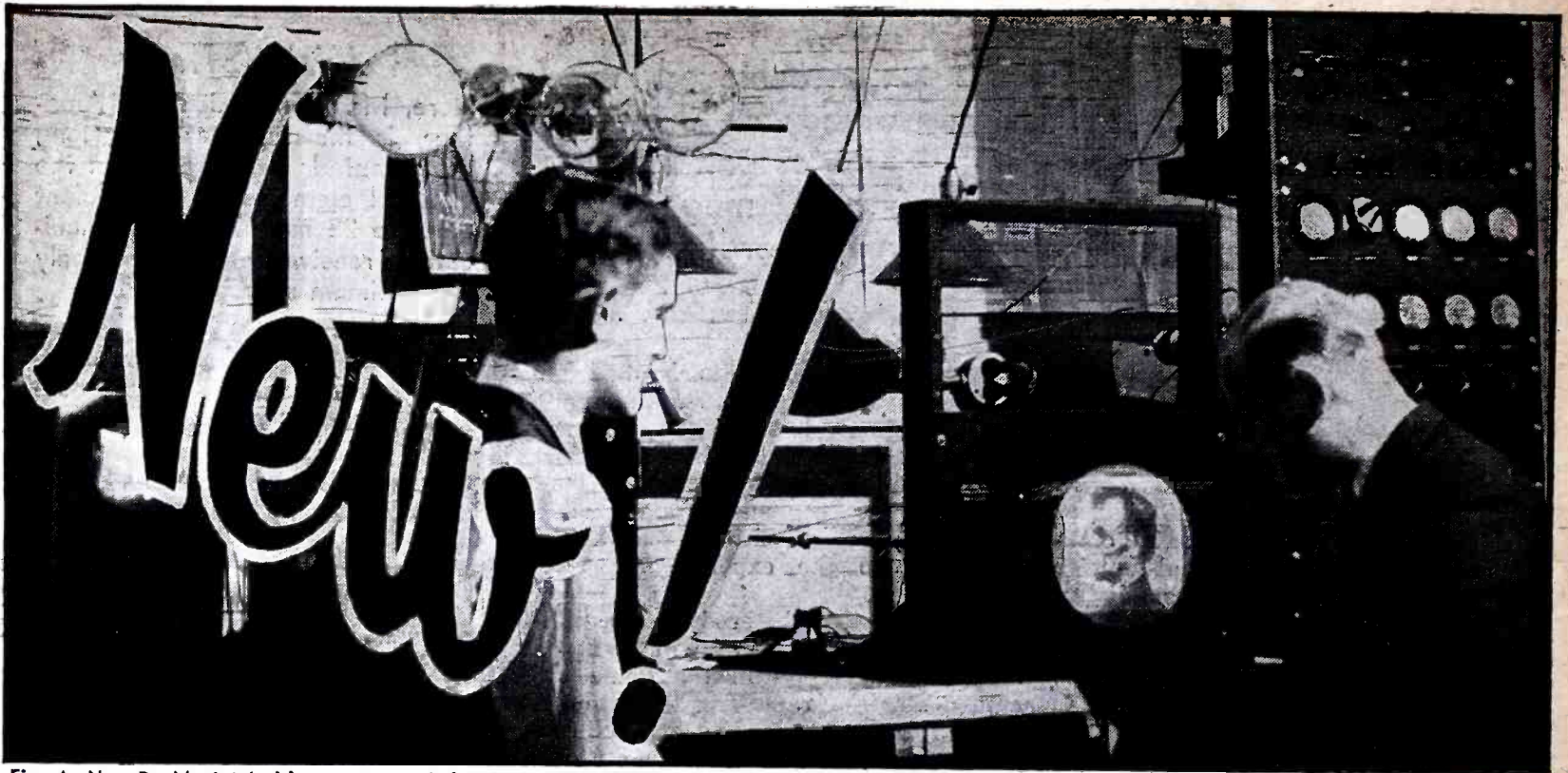

Fig. A. New Du Mont television apparatus being tested in the laboratory. No sweep, frame, or blocking frequencies need to be generated at receiver.

## THE DU MONT TELEVISION SYSTEM

TELEVISION TAKES A BIG STEP FORWARD! Ingenious new circuit arrangement makes reception—of various numbers of lines per frame and frames per second—possible with simplified television receiving set. A "Phasmajector" demonstrates principles involved.

ALLEN B. Du MONT

**T**ELEVISION systems now being used commercially in Europe and experimentally in this country are basically the same. A photoelectric mosaic tube, scanned by a cathode-ray beam, is used for picking up the images at the transmitter; a cathode-ray tube with a fluorescent screen for reproducing the picture is used at the receiver. Sweep circuits are employed at the transmitter to scan the picture. The video signals from the pick-up tube are transmitted by the video transmitter, as well as complicated synchronizing and blanking pulses. At the receiver the video signal is used to modulate the cathode-ray beam, the synchronizing pulses are used to hold the picture steady and the blanking pulses eliminate the undesired portion of the sweep trace.

### PRESENT SYSTEMS VS. Du MONT SYSTEM

The present systems have a number of disadvantages which, in some measure, have held back their use on as large a scale as sound broadcasting. For one thing the receivers are costly because of the necessity of providing local sweep circuits and separators. Second, a very wide frequency band is necessary for transmission, and, third, receivers can only receive pictures having a given number of lines per picture and pictures per second. There are numerous other disadvantages among which are fussy adjustments at the receiver and the necessity of using ultrashortwaves for transmission which limit the distance the pictures can be sent.

The Du Mont Television System, on which patents are pending, eliminates all these disadvantages and for the first time provides a practical, simple, low-cost television system of high definition. The basic difference between this and the present systems is that, instead of having local sweep

oscillators at the transmitter and receiver, the sweep voltages themselves are transmitted. This in itself seems a simple change—and it is, but a large number of details had to be worked out in order to accomplish this. Considerable work toward this end has been carried out for the past several years at our laboratory, and well over a year ago permission to transmit using this system was requested from the F.C.C., but to date, due to the usual red tape, no decision has been made on the application. Regardless of this, our tests in the laboratory conclusively prove the advantages gained by this system, which are obvious to technicians when the following facts are considered.

Referring to the various disadvantages of the present system we note that the receivers are costly because in addition to having the usual radio receiver, local sweep circuits with their complicated separator circuits must be provided. With the Du Mont System, the receiver needs no local sweep circuits and is practically the same as the present-day sound receiver, except that it has the higher frequency response necessary for high-definition pictures. Furthermore, no provision has to be made for interlacing which, together with synchronizing, causes considerable trouble in the present system. *To sum up, the Du Mont receiver is practically the same as a modern sound receiver, no local sweeps, synchronizing or interlacing controls or circuits being necessary.*

### WORLD-WIDE TELEVISION NOW PRACTICABLE!

Taking up the point that a very wide frequency band is now necessary, the fact that in the Du Mont System a higher interlace ratio can be employed permits much higher definition pictures with the same frequency band, or allows the same definition picture to be transmitted on a much

narrower frequency band. The reason for this is that, because of the difficulty of synchronizing and interlacing with the present system, it is impossible to use a higher ratio than 2.

In the Du Mont System, because it cannot possibly be out of synchronization, there is no limit to the interlace ratio; hence the saving in both the radio spectrum and the receiver is considerable. With present systems a 6 megacycle band is necessary for 441 lines, 60 fields per second and an interlace ratio of 2.

Our tests have shown that, with the same number of lines and frames per second, we can use an interlace ratio of 4, requiring a frequency band of only 3.0 megacycles. This means that two transmitters can be used where only one can now be used.

Furthermore, a longer wave band can be used, allowing world-wide transmission. Taking this from another angle, if we decide to use the full 6 megacycle band we can transmit pictures of 882 lines, which is comparable to the finest motion pictures now available. In addition the receiver will have only the same frequency requirements as at present.

#### A QUESTION OF ECONOMICS—ANSWERED

The third point to be discussed i.e., that with the present system receivers can only receive pictures having a given number of lines per picture and pictures per second, is important because the greatest reason for holding back commercial television, in the opinion of the writer, has been this consideration. No company will assume the responsibility of bringing out sets with a certain definition (number of lines) and have them become obsolete in a year or so because of advances in the art. Yet, with the present system, this holds true. Changes have been made in the past seven years, raising the number of lines from 48 to 60 to 120 to 180 to 240 to 343 and now to 441. The present detail is fairly good, but nowhere near the ultimate, and it is certainly not desirable to make sets useless when further changes occur or to decide now on a standard which later on would be undesirable. With the Du Mont receiver a picture of any number of lines can be received, up to 882, providing the receiver has amplifiers at least as good as those necessary for present 441-line transmission. A person buying a receiver using this principle can see pictures from transmitters using various numbers of lines and, when the transmitters increase the detail (number of lines), his receiver does not become obsolete.

In this new system the video transmitter does not have any synchronizing or blanking pulses inserted in the video signal, so the full power is available for picture signals (instead of only 80% with the present system, due to 20% of the power being necessary to transmit the synchronizing and blanking pulses).

The line and frame sweep voltages have been transmitted with satisfactory results by several different methods. In one method these voltages are transmitted over the audio carrier. The line frequency is above the audio range and a simple filter keeps this frequency out of the loudspeaker. The frame frequency is also transmitted and means are

*(Continued on page 705)*



Fig. B. An unretouched photograph of the screen on the receiving tube.

### Du MONT DIGEST

#### PRESENT SYSTEMS

- (1) Framing circuits in receiver.
- (2) Scanning circuits in receiver.
- (3) Blanking circuits in receiver.
- (4) Wide frequency band (6 mc.) needed for transmission.
- (5) Receiver set for one number of lines per frame and frames per second.

#### DU MONT SYSTEM

- (1) Framing impulses transmitted.
- (2) Scanning impulses transmitted.
- (3) Blanking impulses transmitted. (May be done on sound channel.)
- (4) Narrower frequency band (3 mc.) needed for transmission.
- (5) Receiver can reproduce any number of lines per frame and frames per second.

The author, a television and tube designer of many years' experience, brings to the field of cathode-ray television a number of new ideas, which appear to offer the following advantages:—

- (1) Lower cost of receiver construction.
- (2) Possibility of putting more stations on the air in the channels allocated.
- (3) Interlacing is done automatically, through the transmitted signal.
- (4) Detail of 882 lines may be transmitted on a channel no wider than those now used to carry 441 lines.
- (5) Standardization of detail unnecessary, as receivers using Du Mont System can tune to any number of lines and/or frames, when same transmission is used.
- (6) Signal strength 25% greater, as impulses need not be carried with video signal (may be with audio).

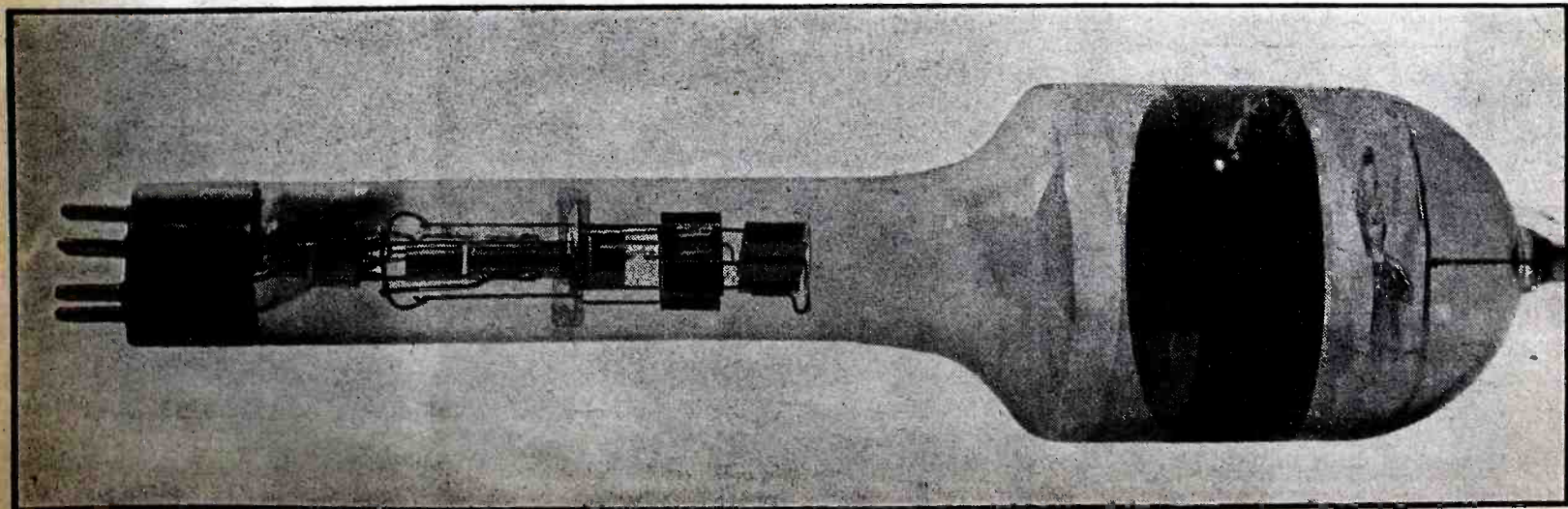

Fig. C. The "Phasmajector", heart of the Du Mont System, which simplifies television reception, yet makes more detail easily possible.

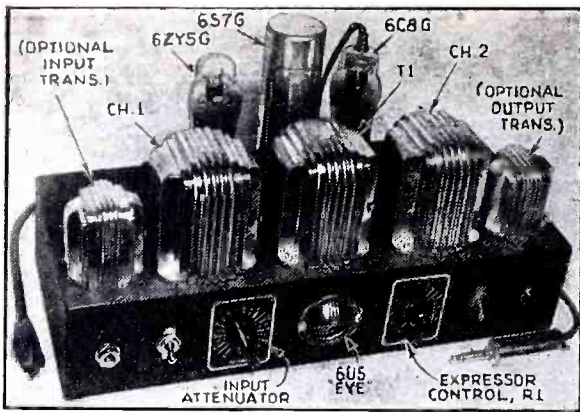

Fig. A. The self-powered audio "Expressor". Note the visual "level" indicator.

# NEW! AUDIO "EXPRESSOR" FOR SOUND SYSTEMS

You add this unit to your existing sound system. It (1) properly corrects the dynamic range of recordings; and (2) corrects for changing volume as the orator changes his position with respect to the microphone.

A. C. SHANEY

THE PRESENT trend towards high and higher fidelity has virtually necessitated the development of the new "add-on" unit illustrated in Fig. A. This device, known as an *expressor* (which combines the words *expander* and *compressor* into one term) has been specifically designed for extreme simplicity of operation and maximum performance.

The "expressor" is basically capable of 2 functions, i.e., (1) expansion, and (2) suppression. These may be accomplished in various degrees by adjustment of the expressor control (R1). A flick of

a switch (S1) changes it from an expander into a compressor, and vice-versa. Although expanding circuits are not new, the particular type employed in this expressor is different, not only in its simplicity of circuit elements, but in its stability as well. Before delving into the operating principles employed, it might be advisable (for the benefit of the layman) to review the major advantages derived from the use of an expander.

### WHY AN EXPANDER SHOULD BE USED

In producing musical recordings (particularly of classical selections), some passages may be so low as to be barely audible, while other portions of the same selection may be loud enough to vibrate the walls of a building. These loud passages cannot be properly impressed onto a record because the largest amount of volume that can be carried on a record is definitely limited to the width of the sound wave which the stylus or needle cuts on the soft wax record from which the

master record is made. Too much volume will cause the stylus to break down the walls of the groove and jump into the next track. If this happens, the mold record is ruined. In order to avoid this condition, the music is carefully "monitored" (kept below this dangerous level). In other words, the very loud passages are made lower.

Conversely, very low passages make practically no impression on the wax "master." In fact, sound intensities below some fixed level are lost in the needle scratch. In order to remedy this condition, the very low levels are "built up" so as to definitely activate the cutting stylus.

The overall result of this recording procedure is to "condense" the dynamic range of sound intensities. Although most musical instruments can be subjected to this treatment without undue effect, the recorded version of a symphony orchestra selection is greatly affected.

(Continued on page 710)

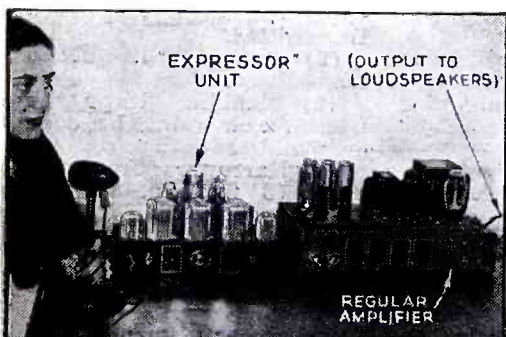

The "Expressor" shown in use between microphone and the amplifier which drives the sound-system loudspeakers or the cutting stylus in the recorder.

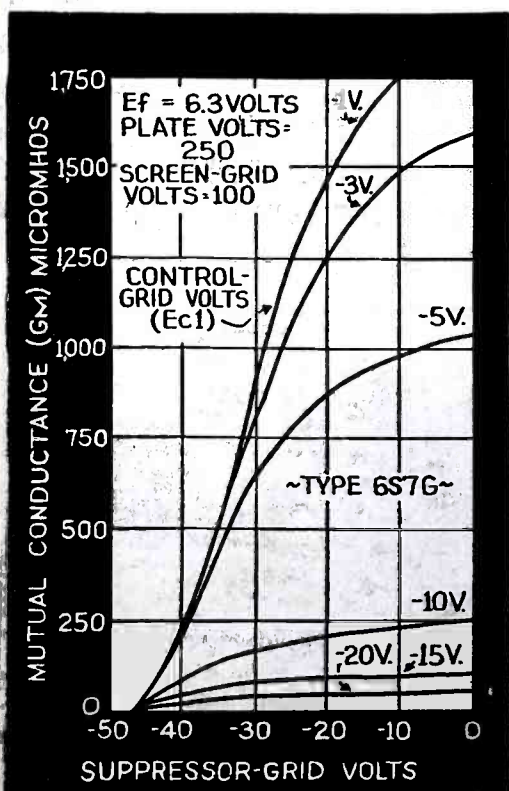

Fig. 2. Effect of control-grid bias on the mutual conductance of the 6S7G tube.

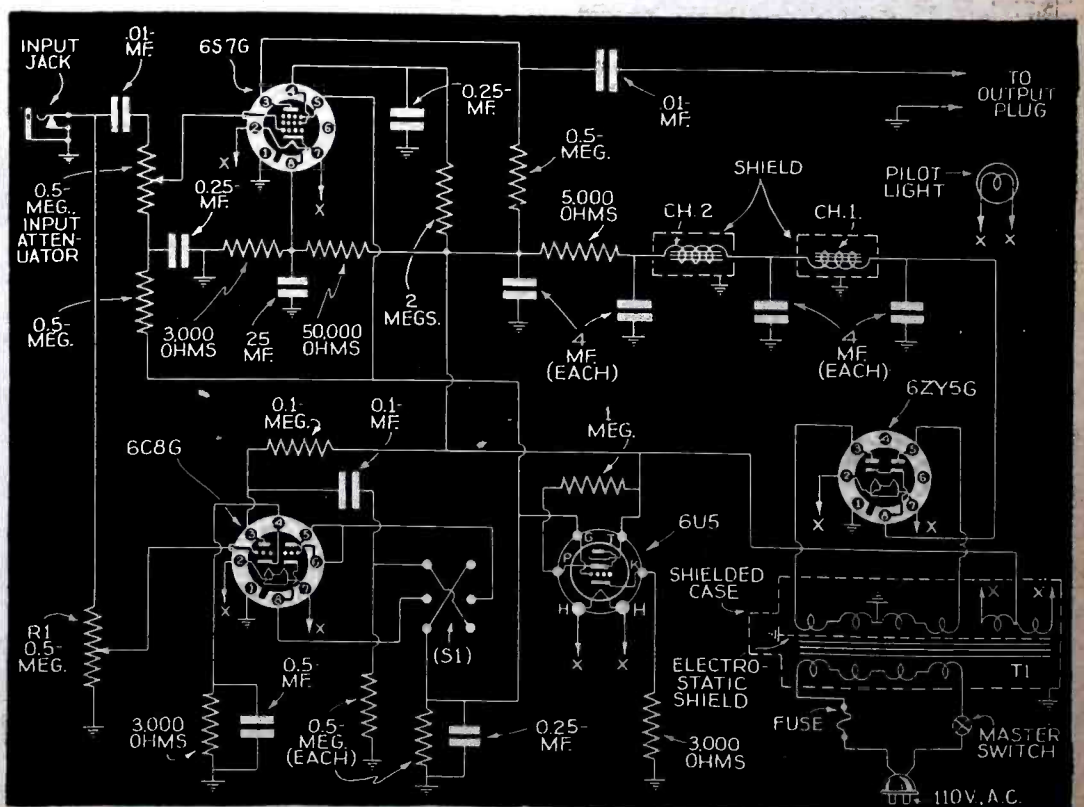

Fig. 1. Schematic circuit of the audio "Expressor" unit. The 6U5 cathode-ray tube is used to visually indicate the degree of compression or expansion present. Note use of anti-hum components.

The world-wide interest in radio is manifested through the activities of inventors in all lands. Reports of their work, garnered from publications in all tongues, are presented for you in this department of *Radio-Craft*.

# INTERNATIONAL RADIO REVIEW

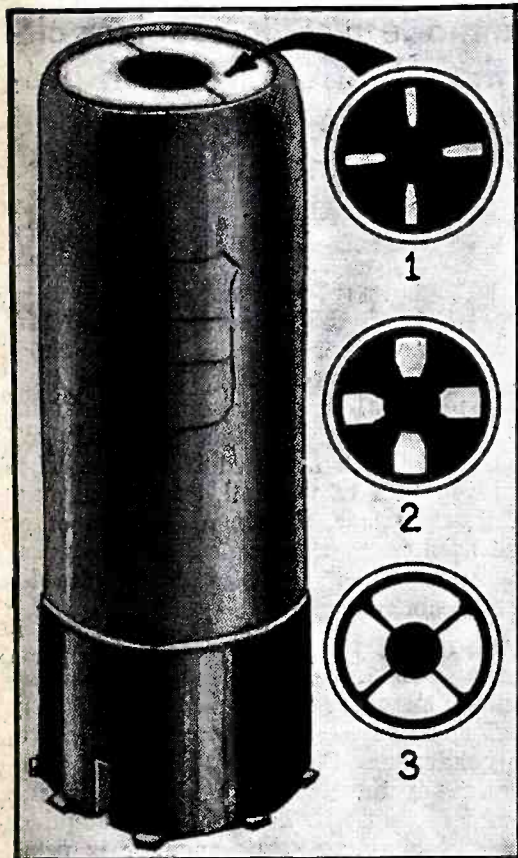

Fig. A. The circles show the "Electron Star" when the set is (1) detuned, (2) partly tuned, (3) tuned.

## BRITAIN'S "TUNING EYE"

A BRITISH version of the familiar American visual tuning indicator (as advertised in *Wireless Weekly*, London) is the "Electron Star" now being included in Philips sets. Instead of a single band of black narrowing as the set is brought to resonance, it makes use of 4 evenly-spaced electron beams which broaden when the set is in tune. (See Fig. A.) While it serves the same purpose as the "eye", it is somewhat more decorative.

## PHONO-RADIO DESK

A 6-TUBE, 5-band receiver, together with a phonograph incorporating an automatic record changer, all housed in a desk and produced by H.M.V. of Britain was recently advertised in *Wireless Retailer and Broadcaster* (London). The price is 50 guineas (about \$275). A panel at the right (see Fig. B) of the desk carries the dial and control; turntable and record magazine are exposed in an open center compartment, for convenience.

## CHAIN-DRIVE DIAL

A NEW German reduced-speed dial drive makes use of an endless chain and sprocket wheel. Its unique feature is that it does not need to be directly in front of the tuning unit it controls. The dial (see Fig. C) may be centered on the panel and the condenser set to one side, if chassis dimensions so require. This is a great convenience for home set-builders as well as commercial designers.

## RECEIVER "IMPROVEMENT"

AN interesting idea is expressed in a patent (reproduced in Fig. D) recently granted Emile Devienne, of Fleurieu-sur-Saône, France. He brings a bared segment of the set's ground lead into close relation with a coil formed in the A.C. power lead, the distance being micrometrically variable by means of a knob and screw. It is claimed that this arrangement increases both selectivity and sensitivity. (N.B.: This device has not been tested by *Radio-Craft*, and the Editors are not yet convinced that it will perform as claimed.)

## MONOKNOB SIMPLIFIES CONTROL

CONTROLS are centralized in the "Monoknob", a tuning control produced by Philips and popular in Germany. The accompanying illustration (Fig. E) taken from *Populaer Radio* (Copenhagen) adds detail to that shown (Continued on page 695)

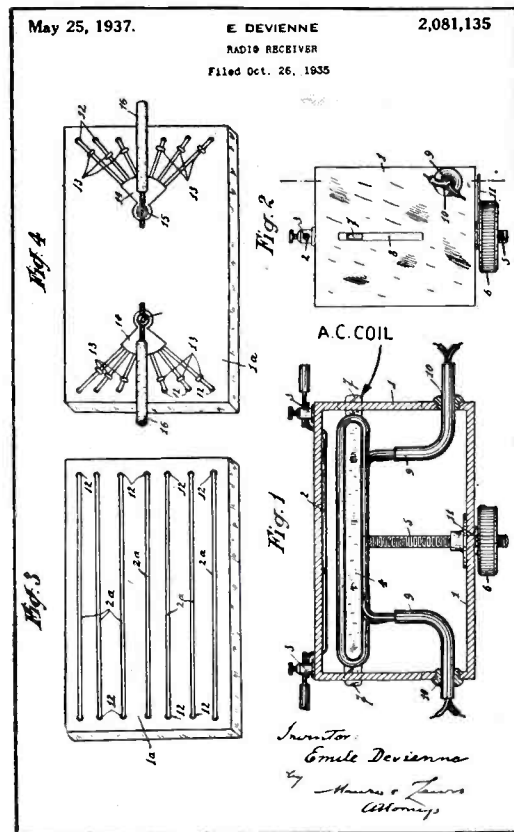

Fig. D. Patent drawing of the "ground tuner"; the principle seems novel—but what about A.C. hum?



Fig. B. Complete radio-phonograph desk.

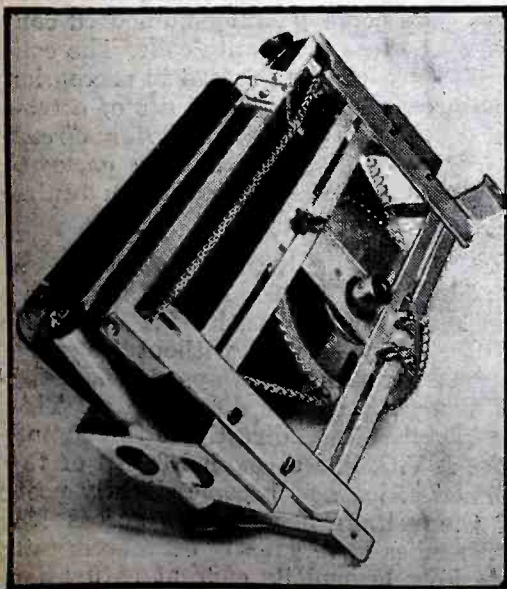

Fig. C. Placement of major tuning parts can be most efficient without destroying panel symmetry, as this chain-drive control permits shifting.

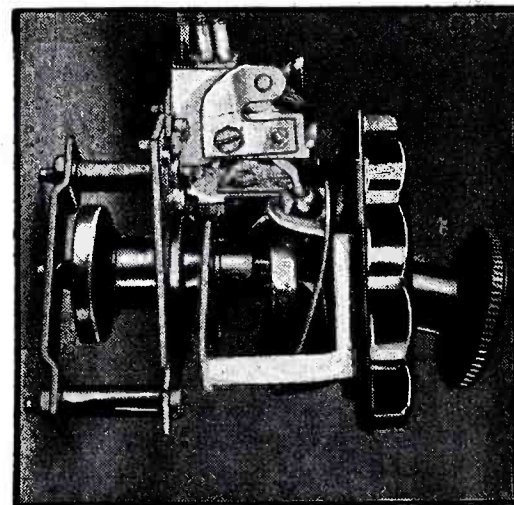

Fig. E. The outer ring provides one control; the inner knob 4 more, as it swings 4 ways.

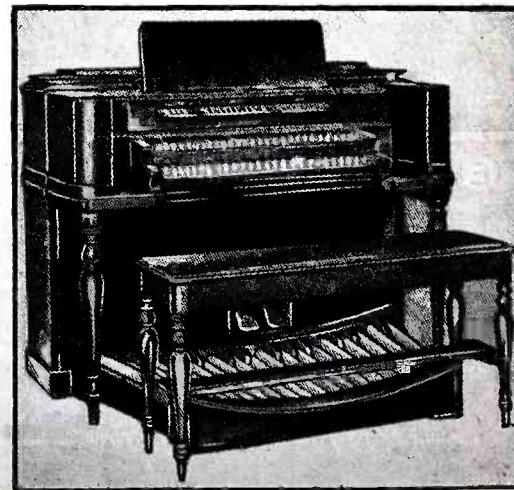

Fig. F. Diapason, flute and string tone colors are produced by this midget organ which uses a multiplicity of condenser-type microphones.

# NEW CIRCUITS IN MODERN RADIO RECEIVERS

The details of the modern radio receiver circuits that make them "different" from previous designs are illustrated and described each month by a well-known technician.

F. L. SPRAYBERRY.....No. 7

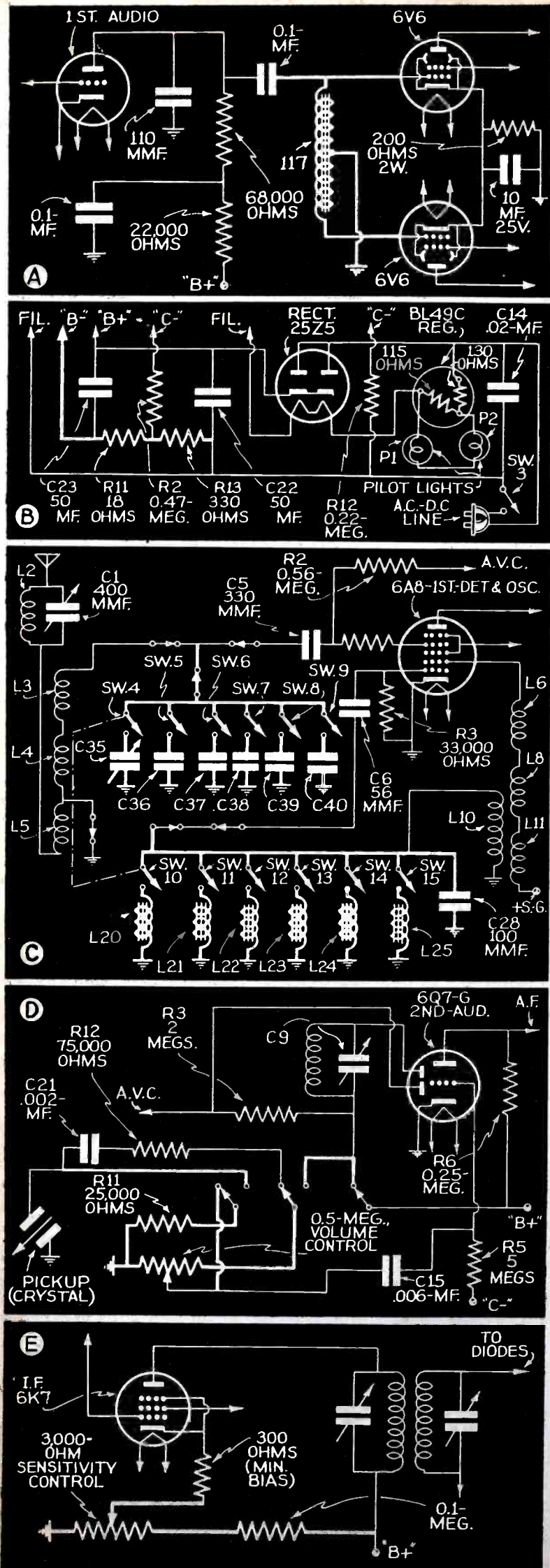

Fig. 1. Heavy lines in the circuits accentuate the points discussed in the text.

(1) STEWART WARNER MODEL 1851 TO 1859.  
 Stewart Warner Model 1851 to 1859. Coupling of the 1st audio stage with the power amplifier stage is accomplished by a single, center-tapped choke as in Fig. 1A. The two halves of the choke are identical in inductance value and number of turns, and the coupling between them is very nearly unity as it is acquired with a closed iron core. The voltage induced in the lower-half of the coil, due to current flow in the upper-half is, therefore, within a fraction of a per cent of the voltage applied to the upper-half. Because of the connection, the voltages are of opposite phase suitable for the control-grids of the beam tubes.

(2) POWER SUPPLY FILTER USING NO CHOKES.  
 G. E. Models FD-62 and FD-625. Resistors are used instead of one or more choke coils in the filter system of these models, as shown in Fig. 1B. To compensate for the less-effective filter action, the filter condensers C22 and C23 values are much higher than usual. They have values of 50 mf., each. The resistance values of R11 and R3 are chosen to acquire the correct bias voltages. A magnetic-type speaker is used and thus there is no field coil to use as a filter choke.

(3) SIMPLIFIED PUSHBUTTON TUNING.  
 RCA Victor Model 87K1. For a medium-size set such as this one, it is most practical to employ the fixed-value circuit switching type of pushbutton tuning. A "first position" counter-clockwise setting of the wave-band switch completely disconnects the main gang tuning condensers from the R.F. and oscillator circuits, but connects the antenna and oscillator coils connected in Fig. 1C for the broadcast band.

Substituted for the main tuning condenser in the R.F. grid circuit are 6 adjustable condensers, each capable of adjustment over about 1/3 of the band. In this way, any 6 stations may be pre-set so that when the individual push-button switch is used the circuit will be tuned exactly to the desired predetermined signal. The oscillator tuning circuit is similarly tuned, but with one of 6 "magnetite"-core (radio-frequency iron) coils shunting the special fixed coil for this switch connection. Each oscillator core may be adjusted over 1/3 of the oscillator band and corresponding numbered condensers are switched in with these magnetite coils. The control switches interlock so that each one pressed in succession will open the former one pressed. Through the use of a temperature-compensating condenser in the oscillator circuit the tuning adjustment is maintained to a very accurate degree. The band switch connections for pushbutton tuning only are shown in Fig. 1C.

(4) "BLOCKING VOLTAGE" PHONO. CUT-OUT "SWITCH"  
 Emerson Models 152, 153, 156, 158, 167. A method is used in Fig. 1D by which the diode, and the entire R.F. and I.F. amplifier systems are effectively blocked without breaking their circuits. Breaking of circuits is always attended by bothersome noises and transient circuit disturbances. This method applies the full "B+" voltage directly to the signal-rectifier diode and to the A.V.C. line through R3. All of the grids ordinarily A.V.C. controlled now become slightly positive although most of the voltage drop occurs across R3. The 1st-detector and I.F. tubes have greatly decreased gain and the diode is considerably beyond its current saturation

(Continued on page 698)

# RADIO WAVES USED TO COMPLETELY CONTROL REMOTE RECEIVER

Wired-radio now makes it possible to (1) turn ON or OFF, (2) tune, and (3) vary the volume, of a remote radio set, by means of a little box that plugs into a wall outlet!

W. E. SHRAGE

**R**ADIODYNAMICS, or control of remote devices by means of radio waves, received a long-due impetus, last month, when attendees at the I.R.E. Rochester Convention learned of a system that obsolesces control tubes (in the remote device) which require being constantly connected to the powerline in order to be operable when the control impulses arrive.

## NO CABLES, NO "ALWAYS ON"

The remote-control system to be described requires neither bothersome extension cables nor must the receiver be constantly connected with the powerline. The new device is absolutely auto-

matic in operation. *Radio signals SWITCH THE SET ON AND OFF, tune in any station desired, and adjust the volume of the speaker to any level desired!*

The fundamental trick lies in the application of a new type of radio tube. This tube, shown in Fig. A, is known under the name "gas-switch-tube" or "thyatron"-type 313A. It is connected, as Fig. 1A explains, on one side with a potentiometer (capacitive voltage divider) consisting of the condensers C3 and C4. At first nothing of special importance seems to be attached to the function of this potentiometer. But as we shall see this is not the case. By

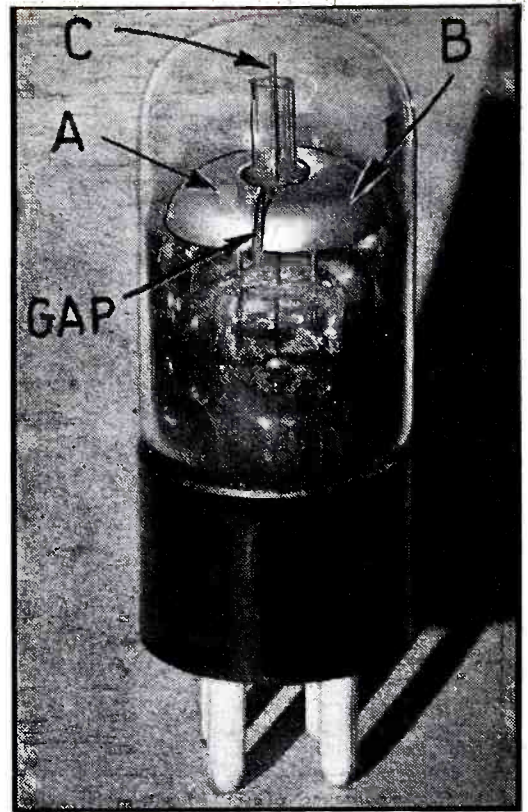

Fig. A. This is the gaseous "switch" tube, type 313A, which does the trick! As shown, it has 3 electrodes, respectively A, B and C, and a gap between A and B. Tube operates in conjunction with a relay. An input to the tube of about 5 ma. will produce a relay current of about 30 ma.

varying condenser C4 one can adjust the voltage across the electrodes A and B to any level desired. Let us examine what this adjustment involves. Any gas-filled tube, such as a neon glow discharge lamp, has a certain breakdown voltage; i.e., the voltage at which a current starts to flow between the electrodes of the tube. For the particular tube applied, the critical voltage is approximately 70 volts.

Now, if we adjust C4 until a voltage of 60 volts exists between the electrodes A and B no ionization will take place in the gap between them, and despite the fact that only 10 volts are lacking to the required breakdown voltage of 70 volts no current will flow through the tube.

Keeping that in mind, let us examine condenser C1 and coil L1. Experienced readers will recognize at once this condenser and coil are the units of a tuning circuit; and, we may add, this circuit is tuned to 300 kc. Everything else is simple. Let us assume a radio signal of 300 kc. is picked up by this tuning circuit whereby the home powerline acts as antenna. What will happen? A radio potential will form across L1. This additional voltage added to the existing 60 volts already across the gap between A and B will cause the ionization of the space between the two electrodes, and a current will start to flow. However, and this is of importance, the current will not only flow between A and B but also between A and C.

The current flowing over electrode C causes relay No. 1 to close, and the receiver, until then "dead as a doornail" starts to operate. It is apparent that by application of a number of tubes and relays of this type, each of them equipped with

(Continued on page 718)

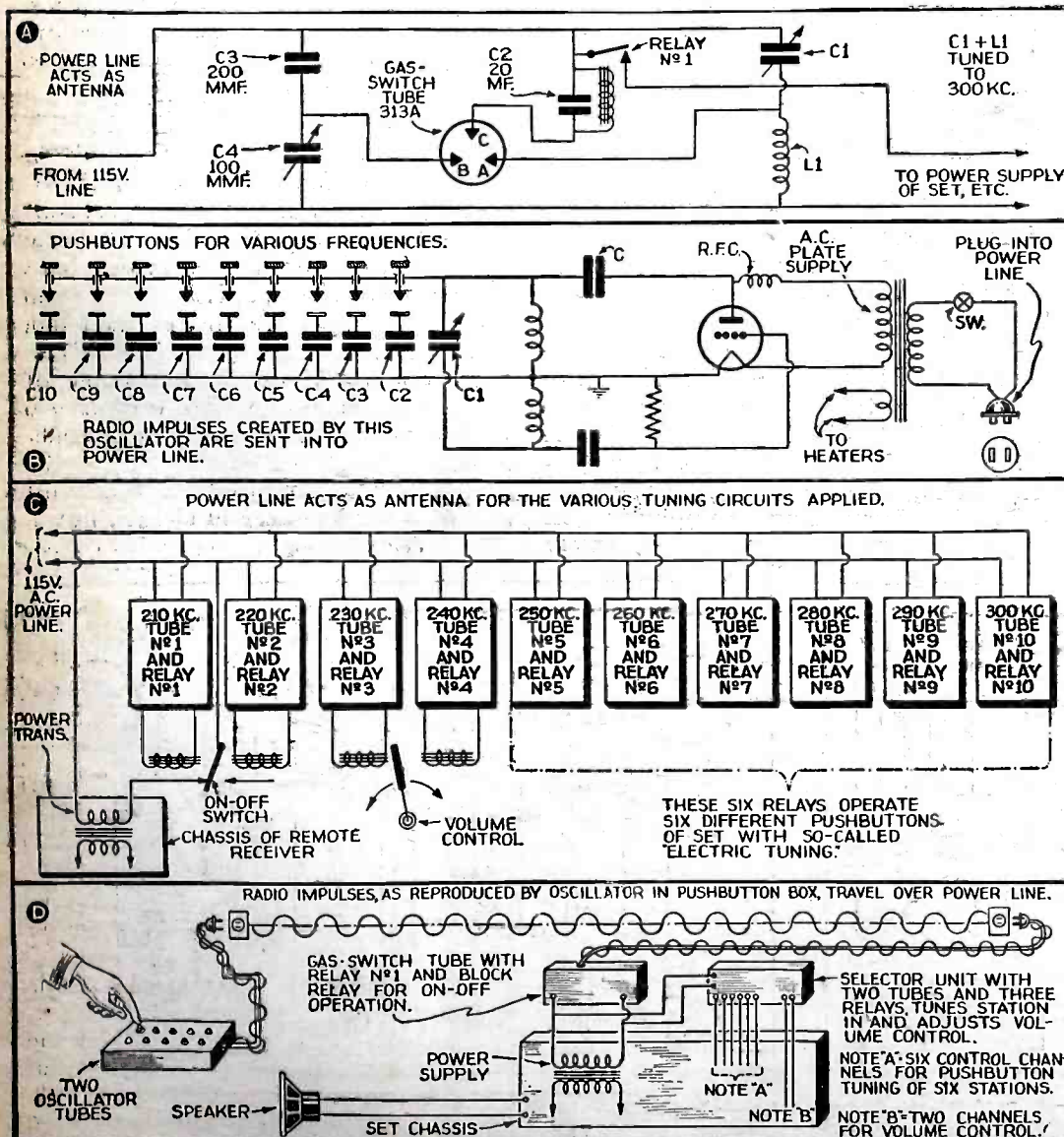

Fig. 1. (A) Fundamental circuit of the 313A "switch" tube and relay; (B) the small, remote-control oscillator which generates 10 control currents; (C) block diagram of the "switch" tube-relay combinations required to remotely tune 6 stations, control volume and turn the set on and off; (D) block diagram of latest revised remote-control system.

# A DIRECT-READING ELECTRONIC "FLUX" METER

From Germany comes this interesting story of a new method for measuring the magnetic permeability of iron and other substances by means of vacuum-tube circuits. Proper design of A.F. transformers and permanent-magnet loudspeakers depend upon such measurements of the flux.

HEINZ BOUKE

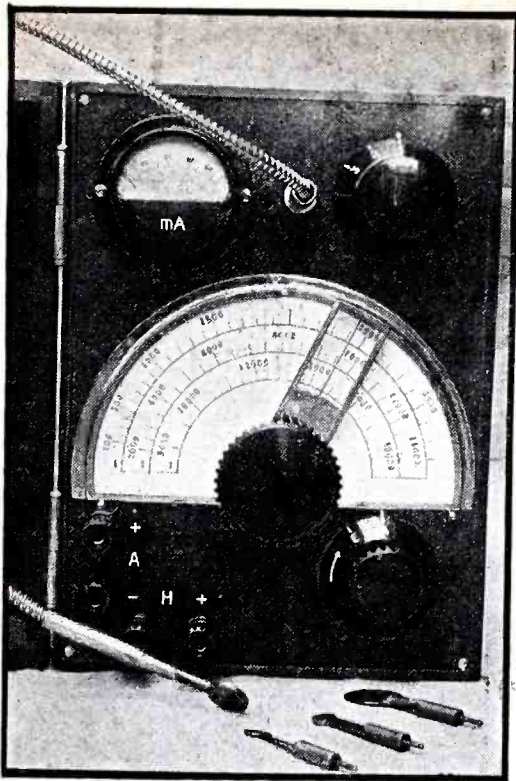

Fig. A. Appearance of the "flux" meter. Upper-left, the galvanometer and right, the band switch. The calibrated tuning scale is in the center. Various sizes of exploring coils are shown below the instrument.

Electronic means are now employed in determining magnetic field strengths. A tiny exploring coil may be inserted in the voice coil gap of a loudspeaker, for instance, and measurements made to within 0.01% by noting differences in a beat frequency.

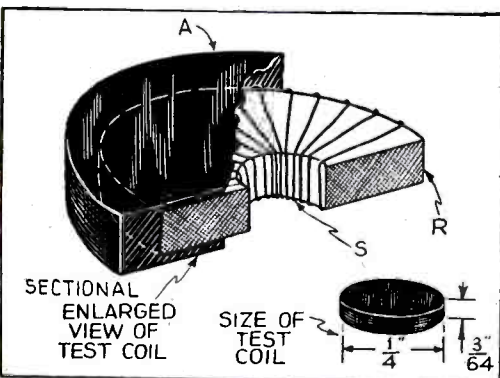

Fig. 1. Greatly enlarged view of the exploring coil constructed of an R.F.-iron core, toroidal winding and protective metal covering and shield. The actual size, as shown, is 1/4-in. wide and 3/64-in. thick.

THE ultimate reason for having at present at our disposal excellent A.F. transformers which have an amazingly straight frequency-response curve is the painstaking research concerning the permeability of iron and iron-alloys. Similarly, the modern permanent-magnet dynamic speakers, which have solved a number of intricate problems in public address work, are also the product of magnetic research. When one knows these facts, this heretofore underestimated line of radio research wins great interest.

But this is not all that makes the new method of magnetic measurements, to be described, so interesting. There is also the fact that the new method of measuring would be impossible without the help of the radio tube. And this smoothing of its own way to progress as done by the radio tube is significant of what we may expect in the future, when this trend is more widely utilized than at the present time.

The ultimate trick of the new method of measuring magnetic effects consists of the application of an extremely small test coil equipped with a modern R.F.-iron core. A customary form of such a coil, with the dimension of 1 x 6 millimeters (3/64 x 1/4-inch), is shown in Fig. 1. The turns S of this coil are arranged in toroid form. Item R is the finely-divided iron core and A is an electric shield, which also serves the purpose of safeguarding the minute coil against deformation, etc. The extremely

small dimensions of this coil have been chosen in order to make measurements inside the smallest gaps possible. For example in the air gap of a dynamic speaker, etc.

This tiny test coil when connected with a circuit as shown in Fig. 2 permits the identification of variation of magnetic flux. Variations as small as 0.01-per cent and even less are measurable. What this extreme sensitivity involves will not only amaze the test engineer in the laboratory, but will probably pay high dividends to every man in the radio field in the form of much improved speakers and transformers.

Now, a few words about the circuit applied. We see, in Fig. 2, two R.F. oscillators (or generators), V1 and V4, which operate on a frequency of about 7.5 megacycles. Both oscillators feed their energy into a kind of potentiometer consisting of the tubes, V2 and V3, and the variable coil, Lv. Oscillator G2 is crystal controlled, and produces an absolutely constant frequency. Oscillator V1 is tuned to the same frequency, but a part of its tank coil is shunted by the tiny toroid coil, LE. In other words, one oscillator, V4, operates with absolutely constant frequency output, but the second, V1, oscillator changes its frequency when the tiny test coil LE is under the influence of a magnetic field.

In order to simplify the matter, no gap of a loudspeaker is shown, but the

(Continued on page 701)

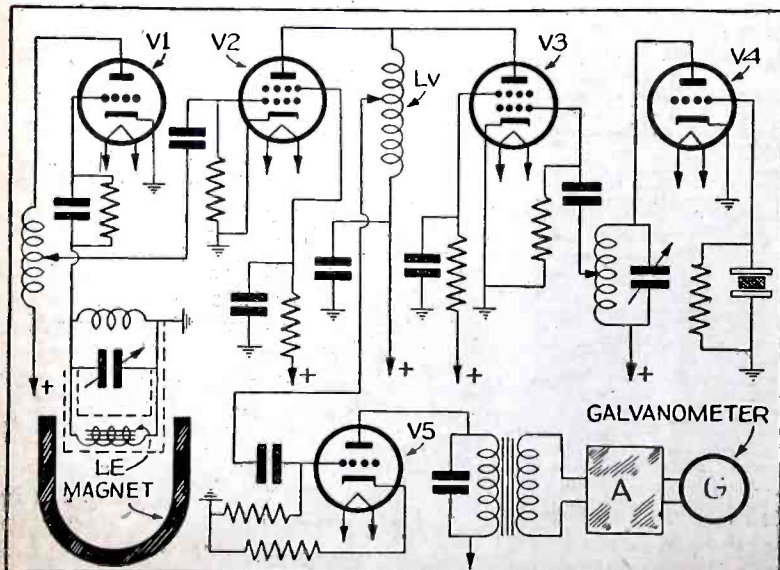

Fig. 2. Fundamental circuit of flux meter using 5 tubes. V4 is the crystal-controlled oscillator and V1 the variable oscillator the frequency of which is governed by the conditions in exploring coil LE. A "beat" note manifests itself as a reading on a meter with a "gauss" scale.

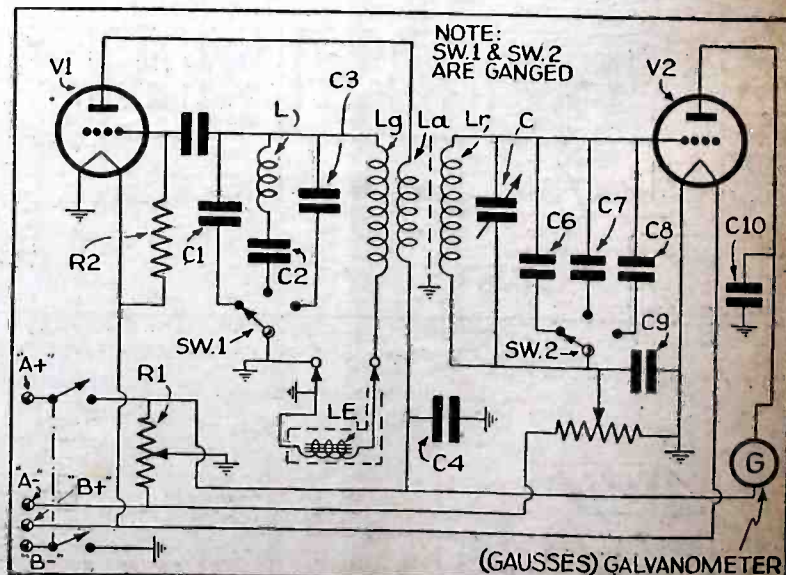

Fig. 3. The simplified circuit of the flux meter using only 2 tubes. Here only one oscillator is used (V1). Coupled to this is a V.-T. voltmeter. A change in frequency in the oscillator is reflected in the V.-T. voltmeter circuit—the difference being read on a calibrated scale.



FIRST PRIZE.....\$10.00  
 SECOND PRIZE.....5.00  
 THIRD PRIZE.....5.00

**Honorable Mention**

**EXPERIMENTERS:** Three cash prizes will be awarded for time- and money-saving ideas. Honorable mention will be given for all other published items. Send in your best "kinks"!

# SHORT-CUTS IN RADIO

## FIRST PRIZE—\$10

**A**N INEXPENSIVE A.C.-D.C. VISUAL OUTPUT INDICATOR. A visual output indicator can be made with nothing more than a 6E5 visual tuning indicator tube and socket, a 30-watt electric light bulb and socket, a line plug, a .05-mf. fixed condenser, some wire, a 1-megohm fixed resistor, and 3 battery clips. The 6-prong socket and the ten-cent-store light socket may be screwed to a small baseboard.

The connections (see Fig. 1) are as follows:— One side of the line plug is connected to the filament and cathode prongs of the tube socket; the other side to one terminal of the light socket and the plate prong of the tube socket. The remaining terminal of the light socket connects to the other filament prong of the tube socket. A large battery clip for grounding the unit is connected to the cathode through the fixed condenser; 2 small battery clips are directly connected to the control-grid and cathode terminals of the socket. These two clips connect to the output transformer of the receiver, in place of the voice coil. The tube is placed in its socket and the 30-watt bulb (preferably painted black to avoid glare) is screwed-in, and the unit is ready to operate. In some cases it works better if a 1-meg. resistor is externally connected between the plate and target prongs of the socket.

The unit may be used on A.C. or D.C., and if care is taken to make sure the cathode side of the plug is always on the grounded side of the line, the fixed condenser may be omitted.

P. J. DONNEAU

## SECOND PRIZE—\$5

**M**IRROR "TILTS" METER WITHOUT INTRODUCING ERROR. In many meters, the counterweight on the needle is not sufficiently well balanced to afford as accurate a reading when a meter designed for horizontal use is tilted for easier reading. This may be avoided by fastening a small mirror, such as women carry in their handbags, over the instrument. It may be propped up temporarily, affixed to the cover of the meter case, or slipped into clips bent from stiff copper or steel wire, as Fig. 2 shows. Of course the reading will be reversed, but, with a little practice, one can read much more accurately this way than by tilting the meter.

HERLUF JENSON

## THIRD PRIZE—\$5

**N**OVEL IMPROVISED DESK STAND FOR MIKE. The inexpensive desk stand for a velocity mike, as shown in Fig. 3, can be made by using a discarded cast-iron or heavy brass light-fixture canopy for the base and an 18-inch piece of pipe threaded to fit the coupling of the mike. The canopy and the pipe should be painted a dull black and, if necessary, the base can be weighted by using a mixture of scrap metal and sealing compound or lead. A piece of felt to cover the bottom of base unit should be cemented on.

Experience will show that a "desk" or "banquet" mike-stand should be of a predetermined fixed height to avoid the trouble and embarrassment caused by nervous speakers trying to steady themselves by adjusting the height of the stand and thereby causing funny noises to come out of the loudspeaker units. See Fig. 3.

LEO J. DRAUS

## HONORABLE MENTION

**M**ULTIPLE HEADPHONE CONNECTION. When several people wish to listen-in on phones, a new type of pin-jack can be improvised. If desired to be a permanent part of the short-wave set or code practice oscillator, it is quickly

*(Continued on page 699)*

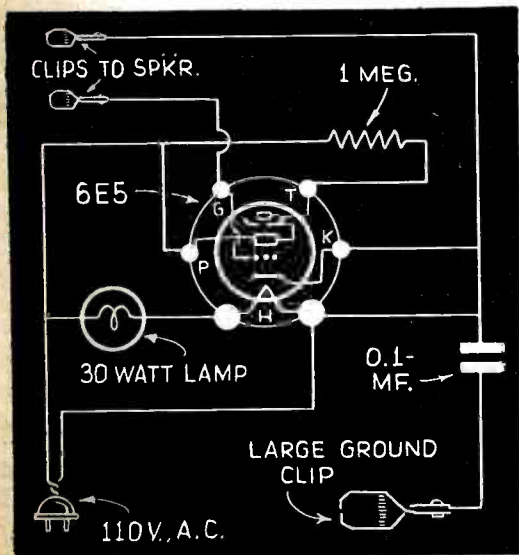

Fig. 1. Efficient output meter is improvised from a 6E5 tube and parts found around any workshop.

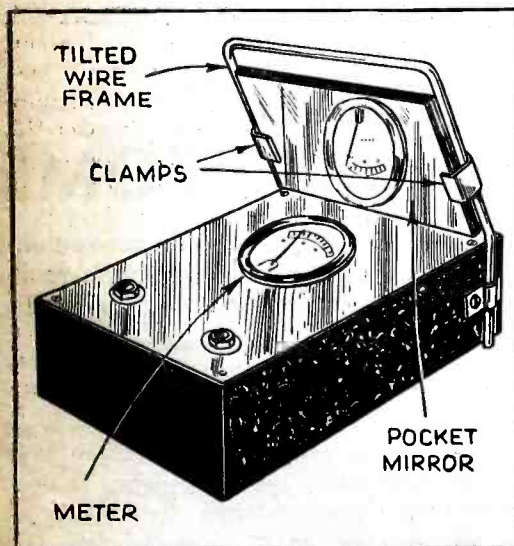

Fig. 2. A mirror fastened above a meter removes the need for tilting; more accurate readings result.

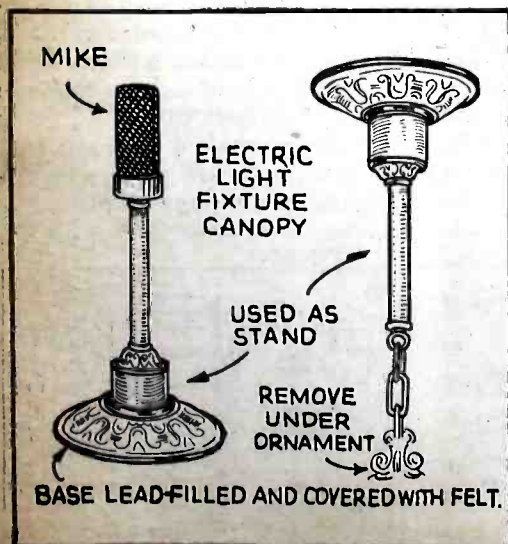

Fig. 3. Part of an old lighting fixture, plus a threaded pipe, makes attractive desk mike stand.

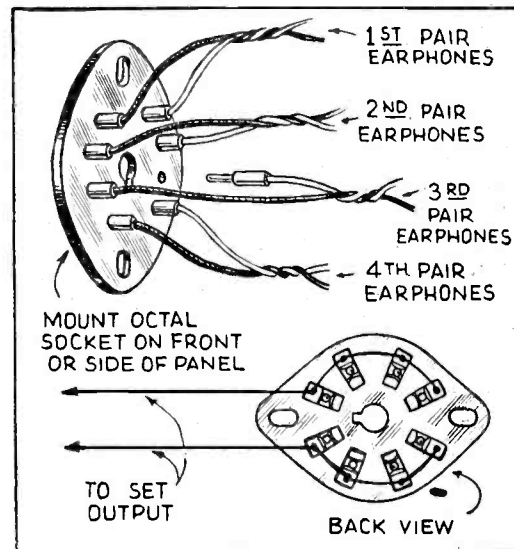

Fig. 4. Octal tube socket fastened to set panel permits 4 pair of phones to be used at once.

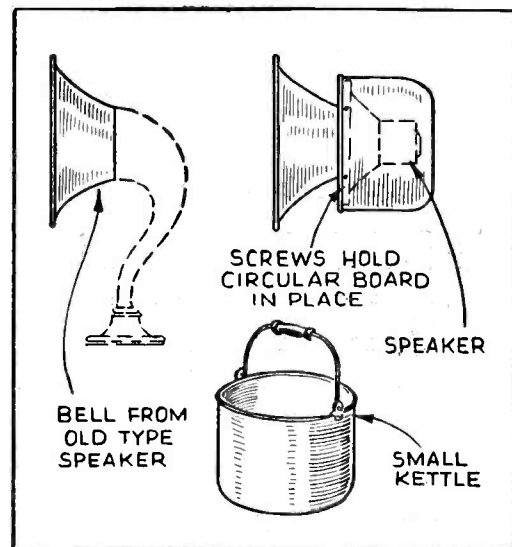

Fig. 5. Bell of old horn-speaker and small kettle form modern portable speaker housing.

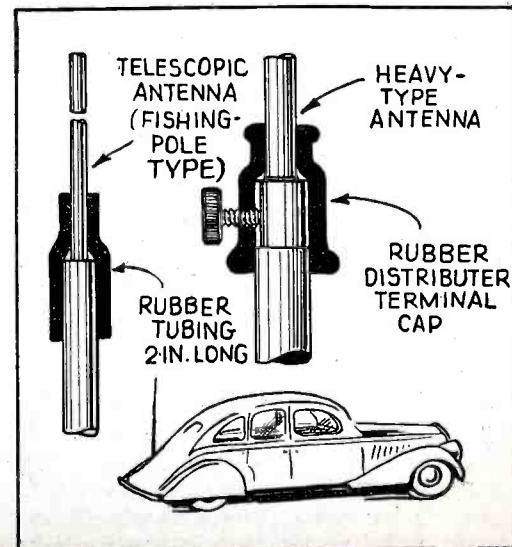

Fig. 6. Rubber bushing on telescoping antenna keeps water out and retards corrosion.

# SERVICING QUESTIONS & ANSWERS

Service Men may write, requesting answers to specific service questions. Address inquiries to Service Editor. For questions answered by mail, a service fee of 25c per question is made. Only questions of wide interest can be published. In view of the "rush" character of most service calls an effort is made to maintain 48-hour service on mail inquiries. Let us help you solve your service problems.

## INTERMITTENT LOW-FREQUENCY RESPONSE

(44) A. L. Tucker, Donaldsville, La.  
(Q.) I have in my shop an RCA Victor model 262 for repair which intermittently loses most of its low-frequency response at low- and medium-volume levels. Otherwise, reception is satisfactory. When the receiver was new, at low-volume settings, with the bass control adjusted for maximum bass reproduction and the treble control set for maximum "highs", the bass tones predominated. Now, on the same setting, the highs seem to stand out.

This trouble is not constant, as the set suddenly flares back to normal at times, or by snapping the power or wave-band switch, reception is made normal. The tubes are OK. The speaker, output transformer, volume control and compensation resistor and condenser have been replaced. All components in the tone control circuit have checked OK. Can you suggest a remedy to overcome this trouble?

(A.) The condition which you de-

scribe was not an uncommon fault with the RCA Victor model 262. Only one of the two chassis turned out under this model number, however, had this difficulty. You state that when the wave-band switch is rotated, reception, at times, becomes normal. Possibly, your receiver employs a fidelity change with band changes. The front section of the wave-band switch attenuates the low-frequency response when the short-wave bands are employed. In the "X" and "A" band positions, the low frequencies are boosted or normal. Check this section of the wave-band switch, as well as the

green common lead of the electrolytic bypass block, which is (or should be) grounded to the same chassis lug as one terminal of the tone-control reactor. An intermittent 1st audio plate filter condenser, a 0.25-mf. unit, will cause trouble. See Fig. Q.44.

## "NO RECEPTION" ON COLONIAL 31 A.C.

(45) P. Pappas, Brooklyn, N. Y.

(Q.) I have a Colonial 31 A.C. receiver in my shop for repair. When the antenna is touched to the plate terminal (Continued on page 720)

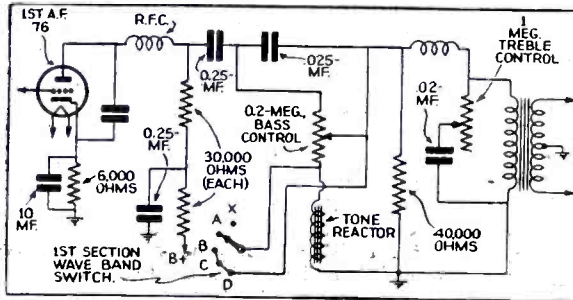

Fig. Q.44

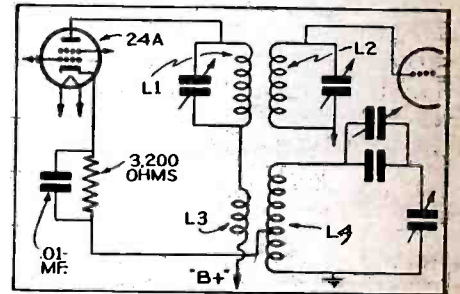

Fig. Q.47

# ANALYSES of RADIO RECEIVER SYMPTOMS OPERATING NOTES

Service Men: Illustrate, wherever convenient, your Operating Notes on characteristic faults of given sets. Payment is made after publication.

Philco Model 70. This model had two common complaints. That of a bad, low-pitched hum and intermittent reception wherein the volume drops to about one-half of its original level at any setting of the volume control. The usual sources of hum were examined without discovering the cause of the complaint. As a last resort a new condenser was bridged across each condenser in the set in turn, starting with the first stage of the set and ending in the output circuit.

This definitely traced the trouble to a condenser in the plate circuit of the 2nd-detector. This 0.25-mf. condenser (Fig. 1A) is connected at the junction of the two resistors, used in series with the plate of the 24A-type 2nd-detector tube and the high-voltage lead, and the chassis. Replacing this cured the hum trouble.

The usual source of intermittent reception in these sets is the audio coupling condenser between the plate of the 2nd-detector tube and the grid of the 47-type output tube. This unit proved to be in good condition so a thorough examination of every part in the receiver was undertaken. The buffer condensers

connected between the power line and ground were found to be the cause of the intermittent reception. Replacing these brought the receiver back to normal operation. These condensers are shown in Fig. 1B. In the early model 70 Philco receivers and similar ones where the volume control is connected in the antenna circuit, an increase in volume can be obtained without harming the control of the volume by placing a jumper between the lug of the control connected to the antenna lead and the lug connected to the 1st radio-frequency coil, the center lug of the control.

WALTER R. WHITCOMB

RCA Victor 118, 211. Intermittent reception on these models, or total in-operation, is frequently the result of an intermittently open-circuiting 10,000-ohm screen-grid voltage drop resistor, a wire-wound unit mounted on the terminal strip located below the power transformer. In many cases, reception can be obtained when the chassis is struck smartly with some suitable instrument. The open-circuited condition, will, of course, be disclosed with a socket analysis by the lack of screen voltage on all but the 41 output tube.

The symptom of choked reproduction may almost always be traced to a short-

(Continued on page 714)

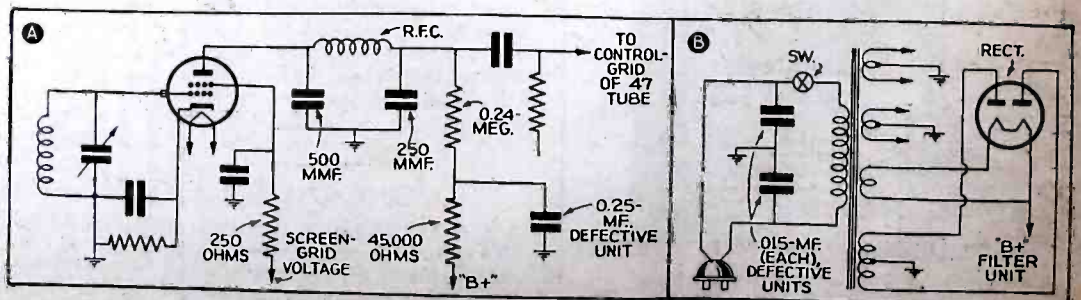

Fig. 1

# 4-TUBE "PEE WEE" T. R. F. RECEIVER

The superlative performance of this "electric" set—one of the smallest in America—enables it to meet special requirements.

THERE seem to be two trends in modern radio receiver design;—the one towards the large, comparatively expensive console or "main" home receiver, and the other towards the ultra-midget or "personal" receiver. The "Pee-Wee" receiver illustrated in Fig. A falls in the latter class and is outstanding in that it is one of the smallest receivers manufactured which has the stability and performance of its larger brethren in the midget family. In fact, tests by *Radio-Craft* indicate that for its size really remarkable results have been achieved in obtaining acceptable tone quality.

Note that this radio set is of the A.C.-D.C. type. This factor plus its small and rugged design makes it an instrument which is particularly suited to services in which the ordinary or larger and more complicated and expensive receiver is not so readily adaptable. This set, for instance, may be tucked into the corner of the traveling case and used wherever a 110-V. supply, either A.C. or D.C., is available; for antenna no additional wire other than the flexible lead supplied with the set is required. The Pee-Wee also may be recommended for the children's room. In this connection it has exceptional entertainment and educational value. This compact set also lends itself to use in hospital wards. Service Men will do well to look into the possibilities of renting this  
(Continued on page 705)

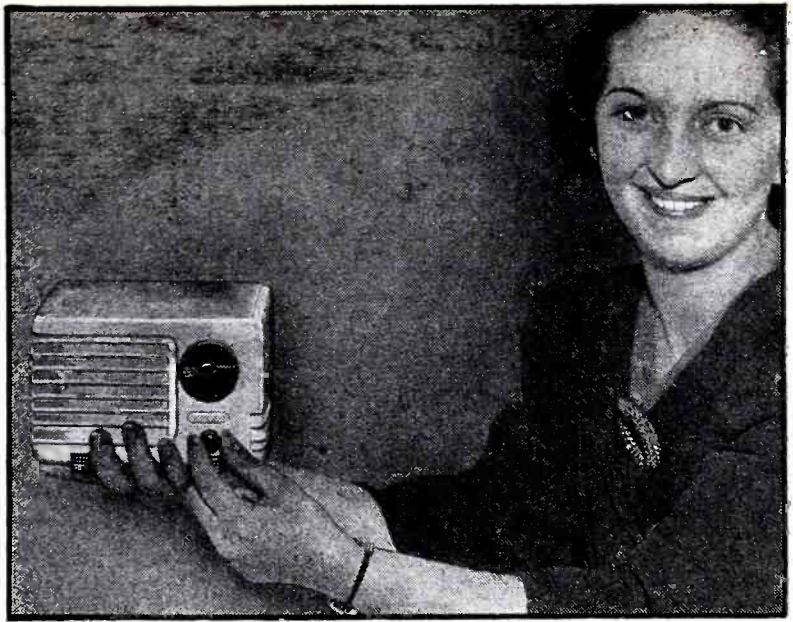

Fig. A. The "Pee-Wee" ultra-midget 4-tube receiver.

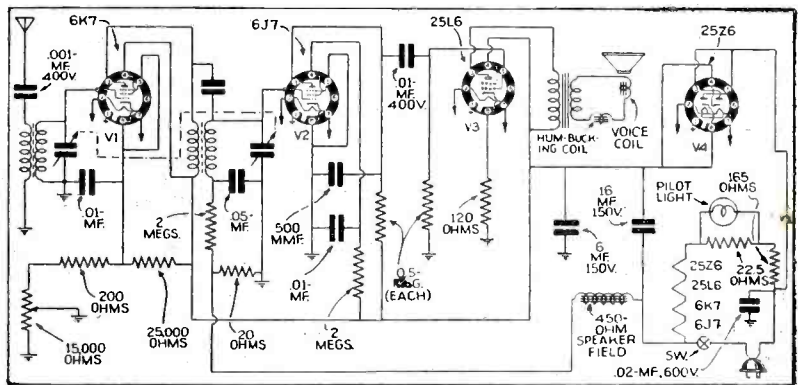

Fig. I. Schematic circuit of the "Pee-Wee" receiver.

Readers of *Radio-Craft* have exhibited exceptional interest in this series of articles—published here for the first time in any popular radio magazine — on constructing experimental C.-R. tubes for television.

## PART V

# TELEVISION STUDENTS LEARN BY MAKING CATHODE-RAY TUBES

U. A. SANABRIA

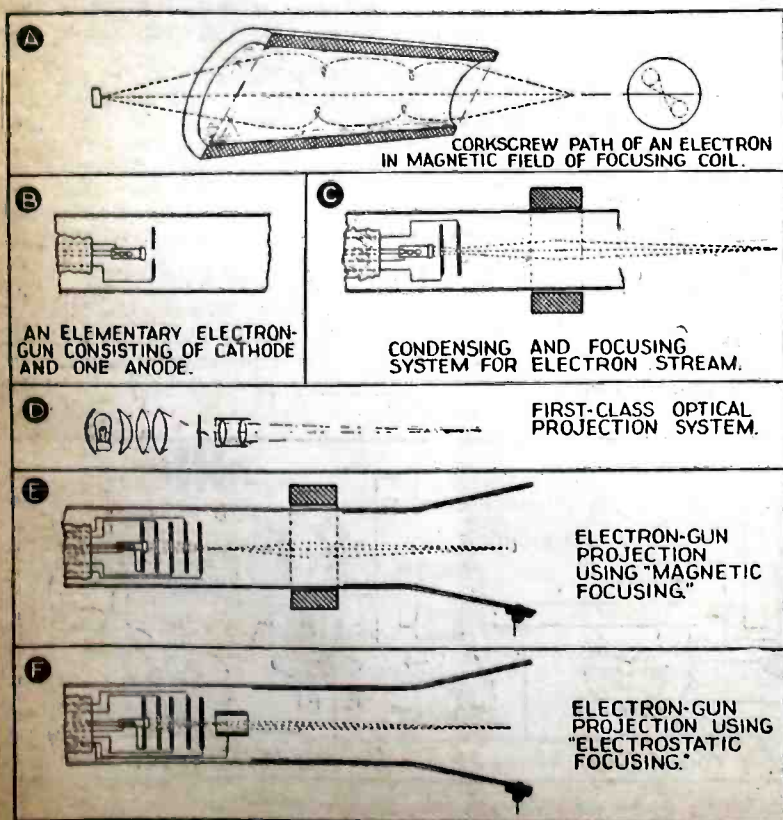

Fig. 4.

LAST month we described our early experiments on the construction of the electron gun and the process for the evacuation of the cathode-ray tube. This month we continue with our experiments with an improved type of gun.

The design of the electron gun was not a pleasant type of task, because the elements were not adjustable during experimentation due to the fact that the elements of the gun were inside of a vacuum tube where they could not be physically reached for adjustment. An ordinary light optical system using lenses can be set up on an optical bench, and the best conditions can be readily found. When the electron optical system is inside an evacuated vessel, obstacles in experimenting occur. For example, you can readily see that a shift of a few thousandths of an inch for one of the electrodes will produce the desired results; yet, you are unable to change the position of an element without rebuilding the whole tube.

Since every part of the tube affects the operation of all the other parts in final performance, it is sometimes difficult to locate the exact source of trouble. At first, this has to be accomplished with a combination of intuition and plodding isolation. It did not take long to find that it was much better to make every part so good in the first place that trouble was unlikely to occur with the exception of those points where you were making your investigations. Learning dimensions and adjustments in cathode-ray tubes consists of making a number of them having different adjustments while taking great care to keep other parts constant in dimensions  
(Continued on page 708)

# RADIO-CRAFT'S INFORMATION BUREAU

## "SERVICE MAN'S AUDIO OSCILLATOR"

(390) C. J. White, Woodruff, Wisc.

(Q.) I went to great pains and no little expense to build the "Service Man's Audio Oscillator" described in the June, 1937, issue of *Radio-Craft*. This oscillator works, but has these 2 faults: It is not stable, and the output does not produce a good, clean wave on the "scope." Can you give me any further tips on connections as shown in the wiring diagram? All of my equipment is of the best quality, and I would like this unit also to be A-1.

(A.) Judging from the above, the trouble is probably caused by one or more of the following: (1) no shielding on the leads emerging from the 2 I.F. transformers; (2) no "thimble" top cap shields; (3) open filter or bypass condensers; (4) plate leads too close to other wiring; (5) tubes that are not sufficiently stable; (6) omission of R.F. filter in plate of 6Q7; (7) omission of plate bypass on 6F6; (8) poor ground return on chassis. The waveform is not sine at low frequency because of the beat between the 2 oscillators.

## "MAGIC EYE OUTPUT INDICATOR"

(391) Edward W. Bayard, Houston, Tex.

(Q.) I have just completed construction of the "Magic Eye Output Indicator," as described in your magazine for April, 1936. Although the actual, physical construction differs from the illustration of your unit, the circuit is identically the same, with 2 minor exceptions. Mine has a pilot light, feeding from the heater winding that supplies the 6B7 and 6E5 tubes, and utilizes the choke from an Atwater Kent model R "B" Power Unit. It therefore has choke input and choke output, with the filter condenser connected to the choke center-tap.

After completion, I turned the instrument "on" and allowed the tubes to warm up. The rectifier output was checked at 300 volts. In a few seconds the tuning eye glowed a bright green with the 90-degree shadow. I connected the positive terminal of a 4½-volt "C" battery to the common tip-jack and its negative terminal to the "LO" tip-jack. The shadow closed approximately half-way; with a lesser voltage (3 volts) the closure was not as great. I then tried 60-cycle A.C. supplied from a small toy transformer with variable taps. Beginning with 1½ volts, the movement was scarcely perceptible. From 8 to 16 volts r.m.s., a slight decrease in shadow width was noted, accompanied by a faint fuzziness at the shadow edge, but it was not clear-cut and bore small resemblance to the illustration in your article.

I next tried various voltages, both A.C. and D.C., with the tip-jack in the "HI" position. Here the movements were even less perceptible than in the "LO" position. The wiring was checked a dozen times, and although I have adhered strictly to the part values as shown and assembled the apparatus in as neat and faultless a manner as possible, thoroughly in keeping with good radio and instrument practice, the unit seems to have an appalling lack of sensitivity. I tried the procedure outlined under "Application and Uses," using a Strom-

berg-Carlson 642 receiver in good condition. The indicator showed very little, if any, response. Finally by removing the speaker voice coil leads and connecting the indicator ("HI" side) directly to the voice coil winding of the output transformer, and having the volume control advanced to the maximum, and tuned to a local station, I was able to observe the varying shadow width as the signal was being modulated. However, the movements were weak and sluggish and had no snap, pep or sensitivity. This result was obtained only with the receiver operating at full power. It wouldn't do, then, for aligning a receiver with A.V.C., or detecting minute variations of signal strength, or gain in successive R.F. stages.

Thinking the voltage impressed on the tubes might be too high, I reduced it to 250 volts, but the results were the same.

I have come to the conclusion that something must be wrong; probably some part shows wrong value, due to typographical error, or the wiring is shown in error. All parts I used are of the highest quality and have been tested and retested and are okay.

(A.) You state in your letter that you use choke input and choke output with a condenser between the 2 chokes.

Please notice carefully that the schematic circuit shows a 4 mf. electrolytic condenser, connected *after* the filter choke. This condenser is *absolutely essential* to the proper operation of the unit. Its omission will cause all the troubles you mention.

In addition, if you want lightning-like action of the shadow, just omit the 0.5-meg. resistor and 0.1-mf. condenser which are connected to the 6E5 grid.

Incidentally, the editors of *Radio-Craft* are particularly glad to publish your letter as a "horrible example." You used excellent parts and constructed your apparatus with skill, yet, because you did not follow the diagram, the unit failed to function correctly. Sometimes errors do creep into diagrams, but this does not occur often. Readers—all readers—are therefore urged to build their apparatus according to instructions. If they must try some variations, and if as a result the unit fails to operate, they are advised to change it to be in accordance with the diagram before taking too much time and trouble to check and recheck the components.

## A.C. FROM BATTERY

(392) D. L. White, North Emporia, Va.

(Q.) I am a repairman on battery sets and live in the country. There is no A.C. where I live and I want to enlarge my home workshop so that I can repair electric sets, too. Please advise how I can make a cheap rig to test A.C. receivers with a storage battery and "B" batteries.

(A.) You cannot properly test an A.C. set with storage "A" and drycell "B" batteries. To give but one reason, such tests could not show up defects in the power pack. However, there are two solutions to your problem. The first and best is to buy or build a 60-cycle 115-volt A.C. generator, to operate from storage cells.

The second, is to purchase an "inverter" which is a vibrator-type power supply operating

## SPECIAL NOTICE

Those questions which are found to represent the greatest general interest will be published here, to the extent that space permits. (At least 5 weeks must elapse between the receipt of a question and the appearance of its answer here.) Mark such inquiries, "For Publication."

*Replies, magazines, etc., cannot be sent C.O.D.* Back issues of *RADIO-CRAFT* ordinarily are 25c per copy but those which are more than 1 year old are available only at 50c per copy; except the following issues: 7/29; 1, 2, 3, 4, 6, 7, 9 and 11/30; 5, 6, and 7/31; 6 and 9/32; 7/33; 1, 8 and 9/34; 1 and 8/35; 8/36 1/37 which are out of print.

Inquiries to be answered by mail **MUST** be accompanied by 25c (stamps) for each separate question; answers are subject to subsequent publication if considered of exceptional interest.

Furnish sufficient information (in reference to magazine articles, be sure to mention issue, page, title, author and figure numbers), and draw a careful diagram (on separate paper) when needed to explain your meaning; use only one side of the paper. *List each question.* Be **SURE** to sign your name AND address.

Enclose only a **STAMPED** and self-addressed envelope for names and addresses of manufacturers; or, in connection with correspondence concerning corrections to articles, as this information is gratis.

Individual designs can be furnished at an additional service charge. The fee may be secured by addressing the inquiry to the **SPECIAL SERVICE** department, and furnishing **COMPLETE** specifications of desired information and available data.

from a storage battery and generating 110-V. 60-cy. A.C. This latter unit is much less expensive to purchase than the generator mentioned above. However its overall efficiency is lower and its vibrator unit requires replacement at intervals, depending upon its use.

## CRYSTAL SET

(393) Geo. M. Frick, Chapin, S. C.

(Q.) I am searching for plans and instructions for building one of the best and most efficient crystal radio receiving sets. I live in the country, 22 miles from a broadcasting station.

Can you print plans or instructions for such a set?

(A.) See Fig. 1-393. The coil, L1, is a standard broadcast-band R.F. coil, to be used with a 350 mmf. variable condenser, C1. Notice that the primary and secondary are to be connected together at the ground end; the antenna may be connected to either the primary or secondary, as shown. The crystal may be of any type; you will probably find a galena crystal with variable contact cat's-whisker most satisfactory. The phones are bypassed with a 250 mmf. fixed condenser.

Use the set with a high antenna, at least 60 feet long, and be sure you have a good, sensitive pair of phones.

Incidentally, the editors advise you to build a single-tube set (see Fig. 2-394) instead of a crystal set; it will cost but little more, and will afford far greater entertainment. See the diagram printed in reply to the following question.

## I-TUBE ALL-WAVE SET

(394) Robert C. Wing, Minneapolis, Minn.

(Q.) A short time ago, I found the enclosed diagram of a 1-tube receiver. No instructions

(Continued on page 707)

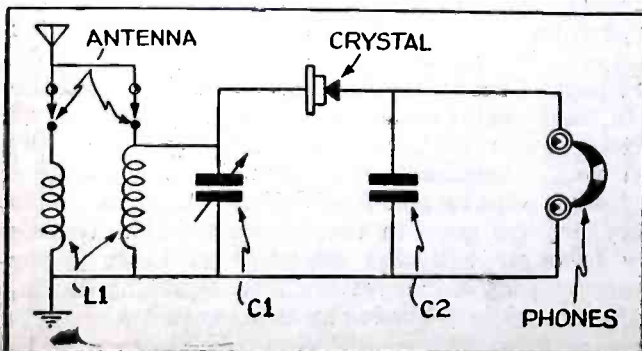

Fig. 1-393. Diagram of a simple, fairly-selective crystal set.

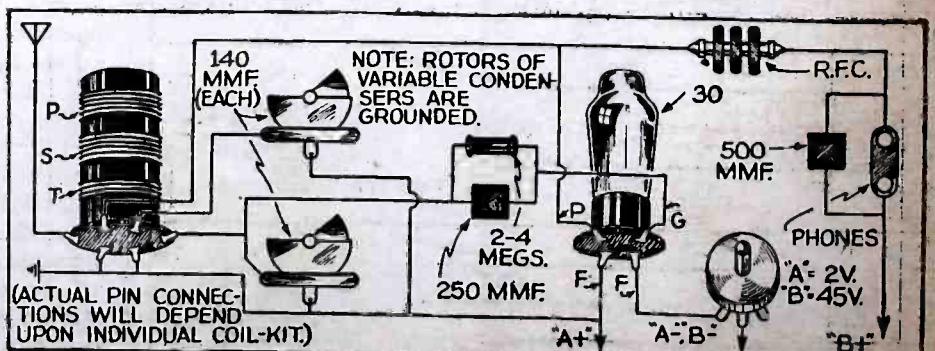

Fig. 2-394. Simple 1-tube set which uses plug-in coils for various tuning bands.

# BUILD THIS SIMPLIFIED NEON-TYPE TEST UNIT

An amateur radio operator tells how \$4 worth of apparatus can be used to construct a simple unit which may be used as a set tester, A.F. oscillator, code practice set, keying monitor for transmitters, etc. A nifty little unit to have around the shop or laboratory.

KENNETH L. HUNTLEY, W8PQP

**T**HE APPARATUS to be described is a very economical and versatile tester and audio-frequency oscillator which should be in the possession of every radio operator and radio Service Man. The component parts will usually be found in the "junk" box. If all the parts are purchased, however, the cost will not be over \$4 and the apparatus easily pays for itself in one or two service jobs.

## THE SERVICES IT PERFORMS

This unit may be used as a sensitive continuity tester for point-to-point testing and also for the testing of the component parts of a receiver or transmitter such as: condensers (mica, paper or electrolytic), transformers, coils, resistors, chokes, etc.

The oscillator may be used as a code practice set, keying monitor or audio oscillator. The frequency of the oscillator is variable from 50 to 10,000 cycles/second. When used as a monitor the unit does not monitor the signal of the transmitter but it does furnish a swell means of checking one's keying and the tone may be adjusted to suit the individual operator.

The component parts are connected as shown in the diagram, Fig. 1. The photograph, Figs. A and B, show the unit which was built by the author, but other designs will probably suggest themselves to the builder as being equally suitable for their particular needs.

## HOW IT'S USED

For point-to-point testing and as a continuity tester a 90-V. D.C. supply is connected to the terminals marked

"D.C. INPUT". (This supply may be taken from "B" batteries, "B" eliminator or other 90-V. D.C. supply). Sw. 1 is thrown to the "OFF" position. The apparatus to be tested is connected to the terminals marked "KEY" by means of test prods.

In testing chokes (both audio and radio frequency), transformer windings, resistors up to 1 megohm, coils, etc., a steady glow indicates a continuous circuit; an intermittent flash indicates poor connection or intermittent circuit; and, failure of the neon lamp to glow, indicates an open circuit or no connection.

In testing condensers (paper or mica type) a good condenser will cause one flash of the neon lamp when the condenser is connected to the test prods. A condenser that causes the neon to glow faintly and does not flash, has poor insulation and should be discarded. Failure of the neon lamp to glow indicates an open condenser and a continuous glow indicates a shorted condenser.

## TESTING ELECTROLYTIC CONDENSERS

In testing electrolytic condensers, be sure the correct *polarity* is applied to the condenser under test and also do not apply more than the rated voltage. The majority of electrolytic condensers will withstand 90 volts, but some of the bypass variety are designed only for use at lower voltages and must not be tested with 90 volts. These low-voltage condensers may be tested by measuring the resistance of the condenser and any that do not have a fairly high resistance should be rejected. (Note: In using a



Fig. A. Front view of the neon tube test unit. Note the tube protruding from the panel.

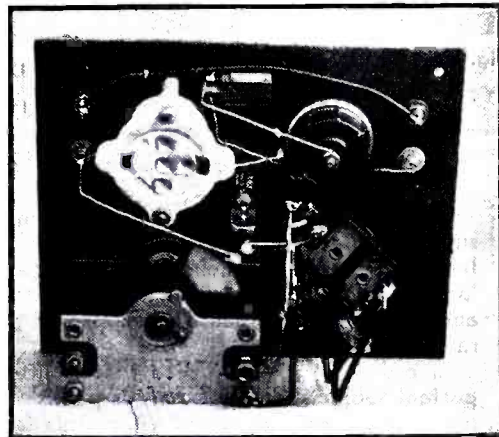

Fig. B. Rear view of the unit showing how the components are mounted vertically behind the front panel.

resistance meter in this test reverse the test prods if a low reading results as the polarity of the resistance tests may be causing the low reading.) Electrolytic condensers may be tested at their rated voltage by increasing the voltage at the terminals marked "D.C. INPUT" to the proper value. Electrolytic condensers will cause the neon lamp to flash once when connected or at regular intervals; if the rate of flash is not over 15 times per second the condenser is satisfactory. Condensers which flash more often are leaky and will cause trouble sooner or later. Condensers which do not flash intermittently but cause a partial glow of the neon lamp are leaky and should not be used. A shorted condenser will cause a bright glow of the neon lamp and failure of the lamp to glow indicates an open condenser.

(Continued on page 699)

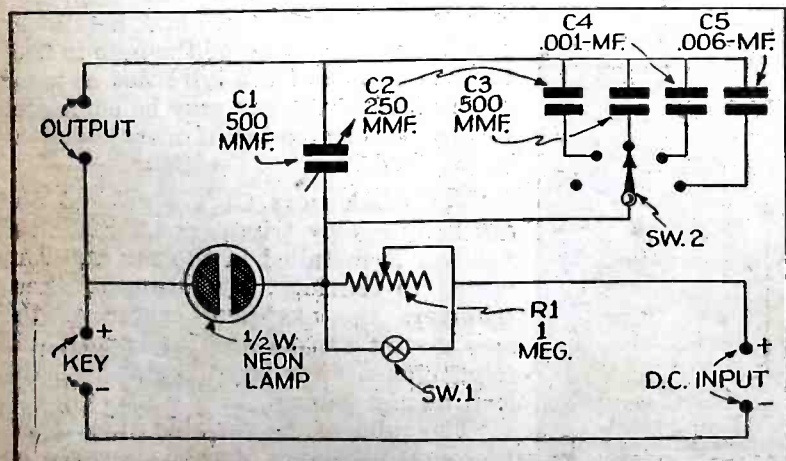

Fig. 1. Circuit diagram of the neon tube test unit showing extreme simplicity of design. Either batteries or an external power pack may be applied.

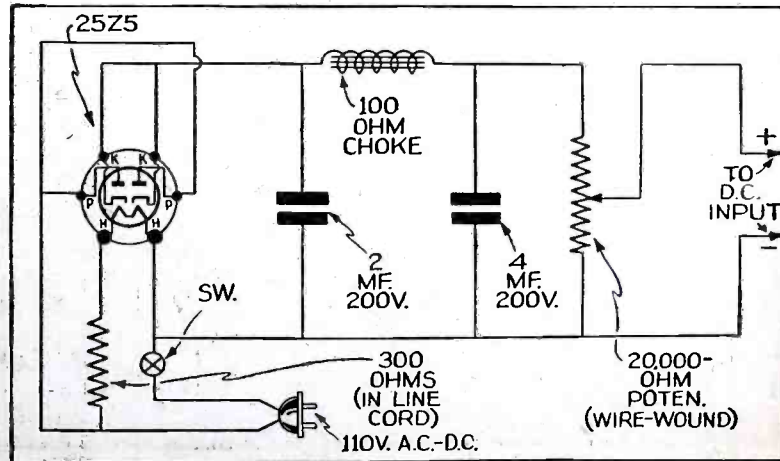

Fig. 2. Circuit diagram of a recommended power supply to be used in conjunction with the test unit. Almost any well-filtered power supply will do.

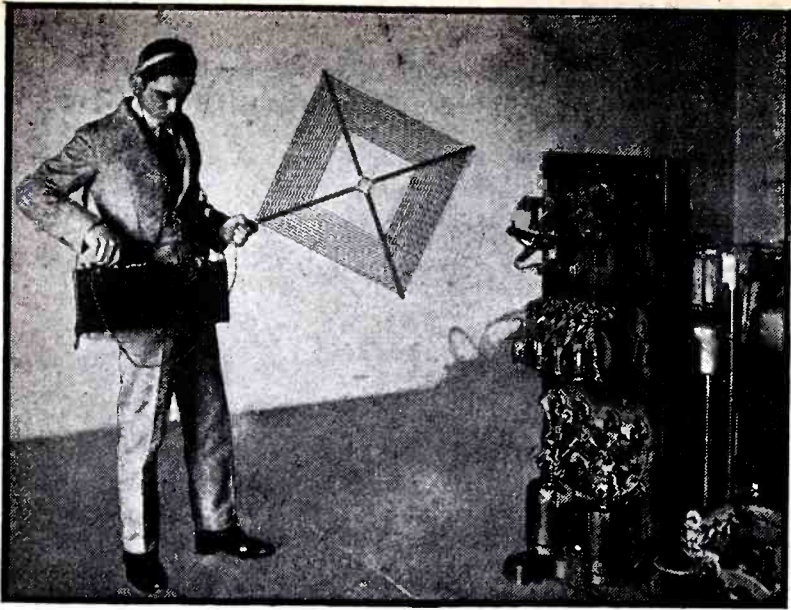

Fig. A. Engineer exploring relay bank suspected of causing interference. The set is battery-operated.

# CANADA'S "INTERFERENCE DETECTIVES"

The problem of man-made static is being solved by the Canadian Government, which maintains "Interference Detectives" who track down sources of "wild" inductive energy and suggest remedies, as described in this "how-to-do-it" article.

PART I

## MAN-MADE STATIC

One of radio's greatest problems is the suppression of man-made interference. Its two principal branches are (a) the location of sources of such disturbances and (b) ending the cause or suppressing radiation.

In order to do full justice to this important subject, *Radio-Craft* is publishing a series of articles, of which this is the first, telling in detail how the Canadian Government is attacking the problem.

THE RADIO BRANCH of the Department of Marine, in Canada, maintains a radio interference elimination service that is serving as a model for governments and radio trade bodies throughout the world.

Since the publication of the first government pamphlet on the subject, in May, 1927, the service has been useful in more than 50,000 cases, resulting in great savings to power companies and in greatly improved reception for radio set owners.

The "Interference Detectives" travel about with loop-equipped cars, in localities from which complaints have been received. The interior of such a car is shown in Figure C. Figure A shows a portable loop set being used to check-up interference from a (building) elevator-control relay bank.

Once the interference is located, means are taken to keep it from getting onto power lines and spreading throughout a territory. This is not difficult on stationary machines, but is a greater problem on such mobile units as trolley cars. The Canadians solved it with filters installed on top of the cars at the base of the trolley pole.

Figure 1 shows the wiring of the standard model of Canadian Government apparatus, designed to be used in conjunction with a converted auto-radio receiver.

It can be connected to the regular car antenna for multi-directional ("vertical") reception; to the loop (rotatable through 360 degrees) for bilateral ("Figure 8") reception; or to both. The latter combination connection affords "sense" (or uni-directional) reception when the variable resistance (Res.) and variometer (L1) (shown in heavy line in the diagram) are correctly adjusted.

The following description of the adaptation of a standard automobile receiver and use of the Inductive Interference Indicator is taken from Canadian Government specifications:—

"The standard automobile receiver is fitted with two extra input terminals marked on diagram (Figure 1) 'Grid' and 'Coil'. The connection from one end of input coil to grid of first tube is broken and the two ends connected respectively to the above-named terminals.

"The loop is mounted on the roof of the car and may be rotated through 360° by means of a handle within the car. The loop proper is constructed of a frame of hardwood 7/8 by 1½ ins. and is 25 ins. long and 17 ins. high. The wiring consists of 12 turns and is embedded in slots milled in each side of the frame. Six slots are milled on each side 1/16-inch wide by 3/16-inch deep, spaced 3/16-inch apart. Enamelled wire is inserted and the slots are then filled-in with plaster, which will form weather-resisting insulation. The completed loop is given 3 coats of black insulating paint. The center-tap of the loop is used for 'vertical' and the wire net antenna in the roof of the car may be connected to the loop center-tap if more 'vertical' is required.

"The condensers C1 are ganged and are balanced by trimmers C2 after the receiver is installed in the car and connected to the loop. By means of these trimmers the electrical center of the loop circuit can be accurately adjusted to compensate for any unbalance in the loop or car wiring.

"The value of the variable inductance, L, found necessary depends largely on the electrical characteristics of the loop



Fig. B. While the "Interference Detective" listens by means of a pair of phones (or loudspeaker, in later models), linesman hits pole suspected of holding defective units. Vibration increases noise.

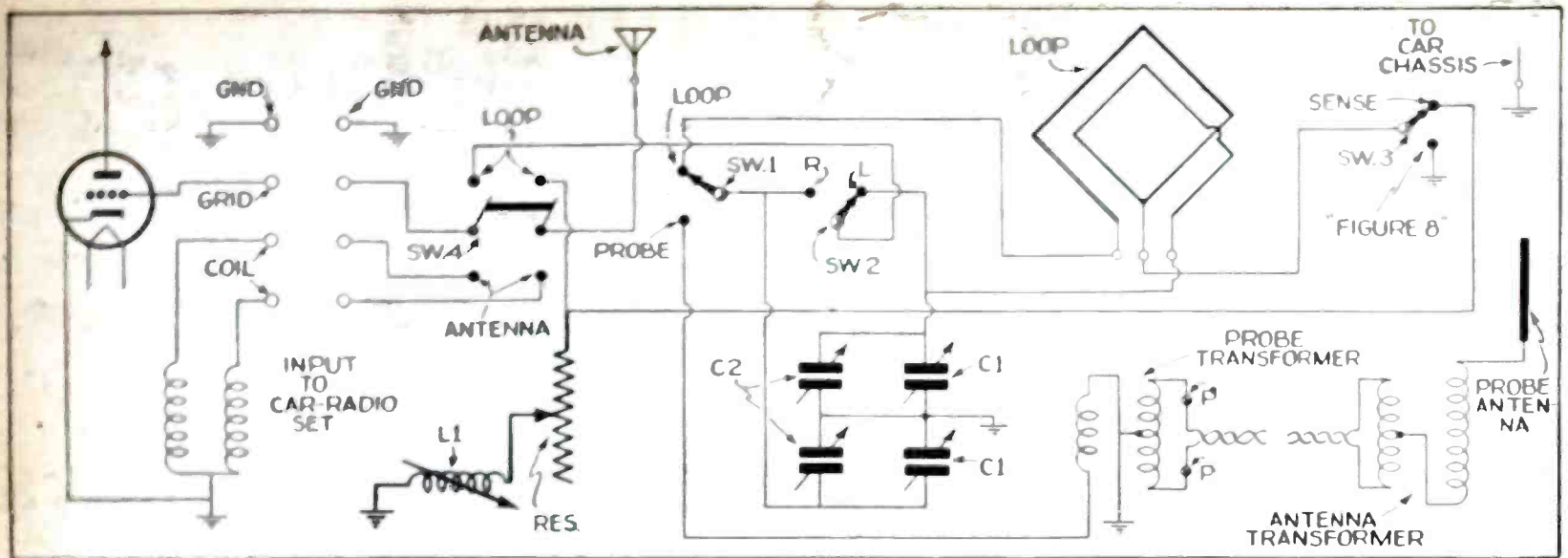

Fig. 1. Circuit of uni-directional (or "sense") circuit, used to track down bad condensers, insulators, transformers, contacts, and other causes of radio interference. Complete specifications of this unit are given in the body of the article.

on the car.

"The variable resistance Res. has a maximum value of 500 ohms and a zero minimum. It is desirable to have the beginning of this resistor tapered so as to give a slow increase in resistance as it will be found that small values will generally be used and the taper assists in rapidly obtaining the correct value.

"The probe transformer consists of a primary, center-tapped, and a secondary wound on a fibre tube 1 inch in diameter. The primary has 20 turns and a secondary sufficient turns to permit one-half of the ganged condenser to tune it to resonance throughout the broadcast band."

The probe used is a 3-inch antenna at the end of a 10 or 15 foot non-conductive rod. It is located adjacent to an antenna probe transformer which connects to a probe transformer in the set through a 100-foot radio-frequency transmission line. This R.F. transmission line has low-impedance characteristics to eliminate the possibility of noise entering the receiver through that source. The antenna probe transformer matches the high-impedance probing antenna to that of the fine while, at the set, the low-impedance line is matched into the high-impedance input of the receiver by another transformer which is identical in design with that of the antenna transformer. The probe unit is insulated for 20,000 volts (since it is used in close proximity to high tension power lines), but (WARNING!) must, nevertheless, be used with the utmost care, and never when headphones are worn.

The probe transformers are as follows:—Aerial primary coil, double layer, 200 turns; secondary, single layer, c-t., 30-30 turns. Set primary coil, single layer c-t., 30-30 turns; secondary, double layer 125 turns. Single layer coils are wound on 1/4-ins. diameter forms, wrapped with 2 layers of friction tape, and the secondaries wound over them. No. 30 silk covered wire is used. A 6-turn coil is removably connected to the potential probe, being in series with the probe primary, when the "detective" wishes to explore for

R.F. current instead of R.F. voltage.

Figure 2 is the fundamental antenna circuit of the interference locator with all switches removed for simplicity.

An output voltmeter is connected across the output of the modified auto-radio receiver.

#### OPERATING INSTRUCTIONS

The arrangement described provides: (A) Non-directional reception; (B) Figure-8 reception; (C) Heart-shaped reception; and, (D) Probe reception.

(A) "Non-directional" reception:

Non-directional reception is obtained by throwing the D.P.D.T. switch SW. 4 to the "aerial" side. This connects the car roof antenna to the receiver in the normal way. It will be noted that this operation is entirely independent of the position of the remaining switches. In this position the tuning dial on the receiver only is required to be adjusted.

(B) "Figure-8" or "bilateral" reception:

The D.P.D.T. switch SW. 4 is closed on the "loop" side.

The switch SW. 3 is closed on the "Figure 8" side.

(Continued on page 703)

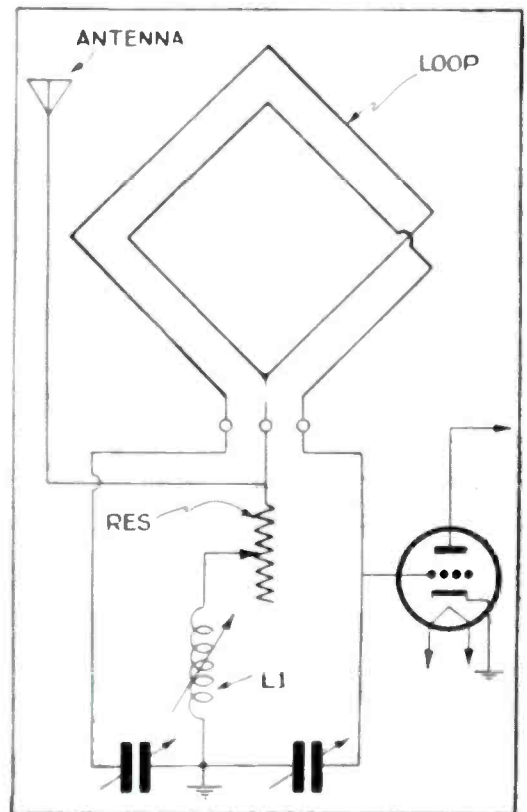

Fig. 2. Basic circuit of the "sense" system.

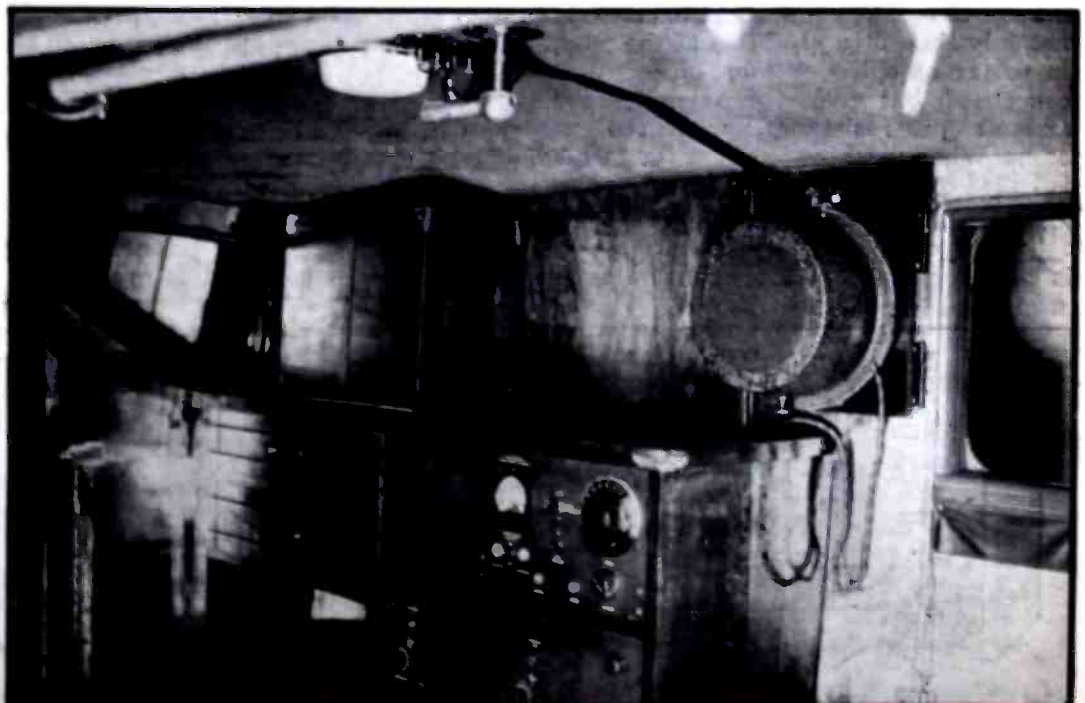

Fig. C. Interior of "detective" car as seen from driver's seat. Note loudspeaker, hinged to be swung out of window. The handle at the top of the car permits rotation of the roof loop from within.

# "LEARN-BY-EXPERIMENTING"

## BEGINNERS' PRACTICAL RADIO COURSE

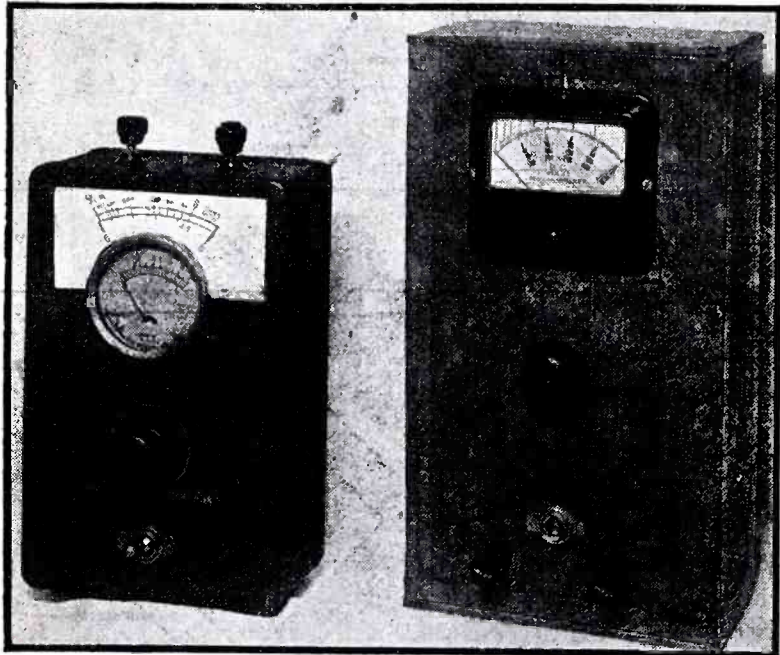

Fig. A. The "roll-your-own" ohmmeter (left) and the alternative (more sensitive) moving-coil ohmmeter (right).

EXPERIMENT No. 5B

### TESTING RADIO PARTS

#### (B) RESISTANCE TESTING

New way of learning radio!—You learn basic principles while building useful radio units. The lessons are directed by a man well fitted for the task . . . a radio instructor. This is the second part of Experiment No. 5.

CONDUCTED BY

SOL D. PRENSKY

**E**XPERIMENT No. 5, viz. **TESTING RADIO PARTS** is divided into 2 sections. The first section, **CONTINUITY TESTING**, was considered in the last instalment (Exp. 5A in the February issue), and showed a method of testing with headphones and a battery to determine whether the part in question was continuous, that is, that there was no break in its circuit.

The second instalment, Exp. 5B (and appearing in this April issue), is called **RESISTANCE TESTING**, and a meter is used to determine the actual resistance of the part in question. This method not only shows the *condition* of the part, in so far as *open- or short-circuits* are concerned, but gives the *value* for the amount of resistance, measured in ohms. When used in this way, the meter is called an *ohmmeter*.

#### PRINCIPLES INVOLVED

The general principle in testing parts is to observe the result when we send

a current through the part being tested. In this case, a low-voltage battery is used, and the amount of current flowing through the part is indicated on the meter. Since we are more interested in the value of the resistance than in the amount of current, the circuit is so arranged that the meter is marked off or *calibrated in ohms*, rather than in milliamperes. Basically, the meter is a milliammeter rather than an ohmmeter, but the term ohmmeter is the accepted name in practice, since the meter is direct-reading in *ohms*.

In selecting which one of the two types of meters is to be used as an ohmmeter, it is important to first decide what type of service is to be expected from it. For the beginner, to whom this will be the first work with meters, it is best to use an *elementary type of meter*, which will enable him to get a general idea of the resistance of the part, that is, whether it is open, high-

resistance, low-resistance or shorted.

This type of meter is the *vane-type meter* where the swing of the needle is determined by the amount of attraction between a pivoted vane made of soft iron and a fixed coil through which

(Continued on page 702)

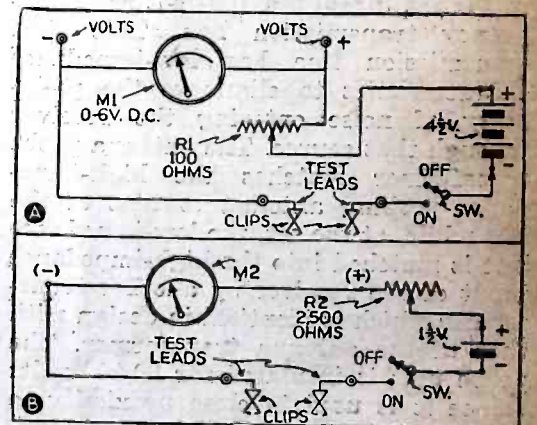

Fig. 2. Schematic diagram of (A) vane-type voltmeter and (B) moving-coil-type ohmmeter.

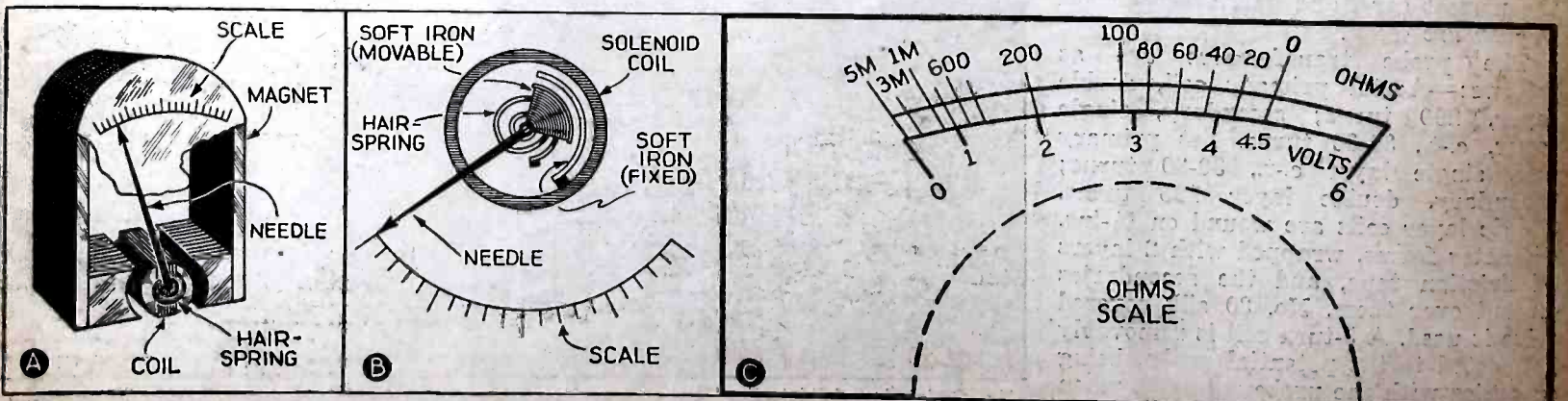
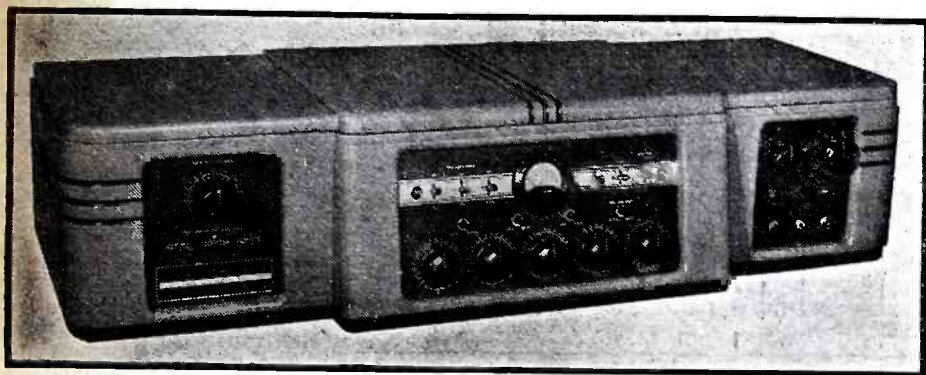

Fig. 1. Showing the internal construction of (A) moving-coil and (B) a vane-type meter; (C) full-size "make-your-own" scale for vane-type meter.



Technicians use this department to keep posted on the newer and better apparatus for use by specialists in Radio, Electronics, and Public Address.

# THE LATEST RADIO EQUIPMENT



This modernistic console shows progress in medium-power sound equipment. (1571)



A modernistic hi-fi police radio transmitter. (1572)

## SPEECH INPUT CONSOLETTA (1571) (RCA Manufacturing Co., Inc.)

PROGRESS in studio equipment design is well-represented in the modernistic 2-studio console-type 8-watt (output) speech input system here shown. Controls 6 microphone inputs plus 6 line inputs at high-fidelity. Provides studio talkback with automatic speaker cut-off; and, cueing for both studios and booth.

## POLICE RADIO TRANSMITTER (1572)

NEWEST in police radio transmitters is the modernistic, hi-fi installation here illustrated. Delivers 38 W., on 30 to 42 megacycles. This transmitter is the first to appear incorporating the new "signal-boosting amplifying circuit" which permits operation at an unusually high percentage of modula-

tion without risk of exceeding the predetermined maximum on peaks.

## A NEW SERVICE TOOL— RESISTANCE ANALYZER AND INDICATOR (1573)

(International Resistance Co.)

A GENERAL-UTILITY instrument useful to Service Men, engineers, experimenters and amateurs. Among its many uses are: voltmeter multiplier; resistance or volume control analyzer; volume or tone control; etc. Section No. 1, 0/30,000 ohms (wire-wound); No. 2, 30,000 ohms/1. meg. (metallized). Both sections controlled by single knob.

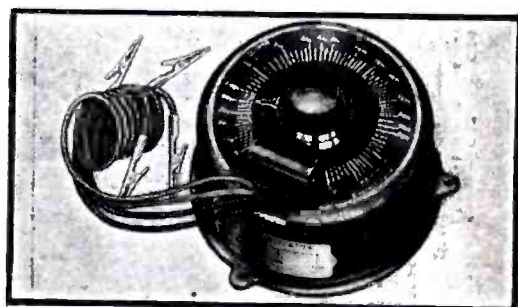

New tool for Service Men. (1573)

## MATCHED-PANEL CLOCK-AND- RADIO SET (1574)

HERE is a 4-tube radio set which at last offers a T.R.F. radio receiver combined with the utility of a clock; and both presented in an instrument of matched design. The electric clock at left, in general appearance, matches the tuning dial at right. Finished in ivory with characters in turquoise blue.

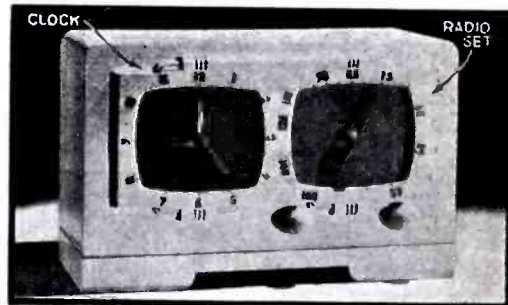

Matched-panel clock-radio set. (1574)

## NEW 4-WATT 100-MC. OSCILLATOR (1575)

HERE is a complete, stable oscillator consisting of tank circuit and vacuum tube, only 7 ins. high. The "secret" of the design lies in the use of the new type 316A tube and a "lumped concentric-element tank circuit." The completed device meets the following

(Continued on page 695)

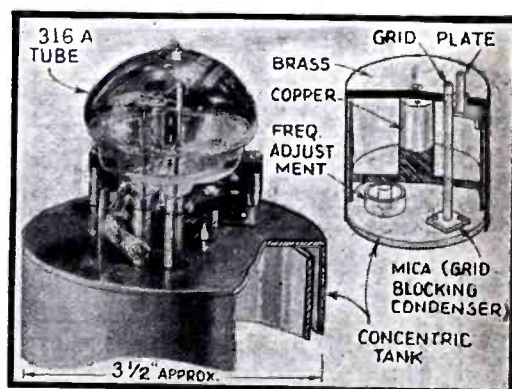

Ultra-H.F. oscillator. (1575)

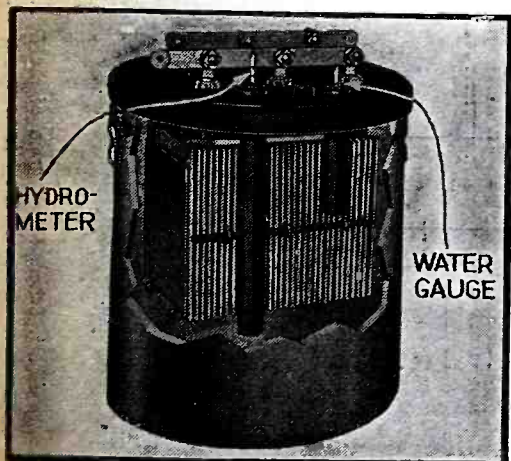

Newest in storage cells. (1577)



Under-pillow crystal speaker. (1579)

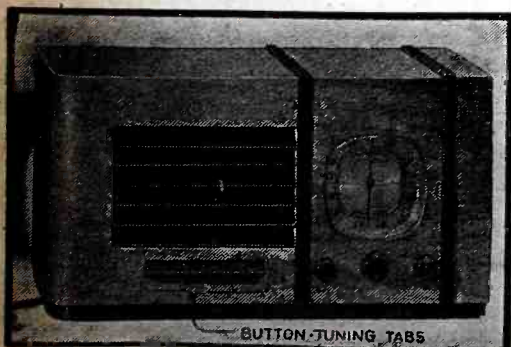

Button-tuning mantel set. (1578)

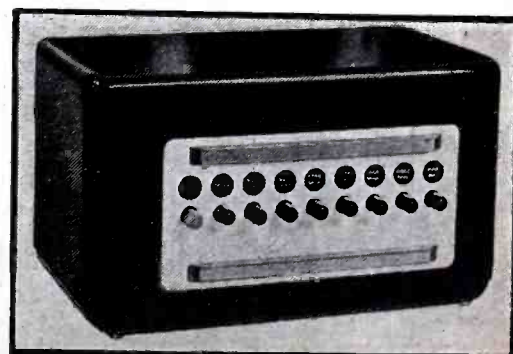

Pushbutton "add-on" unit. (1576)

Name and address of any manufacturer will be sent on receipt of self-addressed, stamped envelope. Kindly give (number) in above description of device.

RCA-VICTOR MODEL 15U, RADIO-PHONOGRAPH

Superheterodyne Receiver, with Expander, Power Amplifier and Automatic Phonograph Mechanism. 15 tubes, total.

ALIGNMENT PROCEDURE

There are 17 adjustments required for the alignment of the oscillator, 1st-detector, and antenna-tuned circuits; 1 adjustment for the wave trap, and 6 adjustments for the I.F. system. Fifteen of these adjustments are made with plunger-type air trimming condensers and require the use of an RCA stock No. 12636 adjusting tool. Each of these condensers has a lock-nut for securing the plunger in place after adjustment. The remaining 9 adjustments are made by means of screws attached to (Continued on Data Sheet 224)

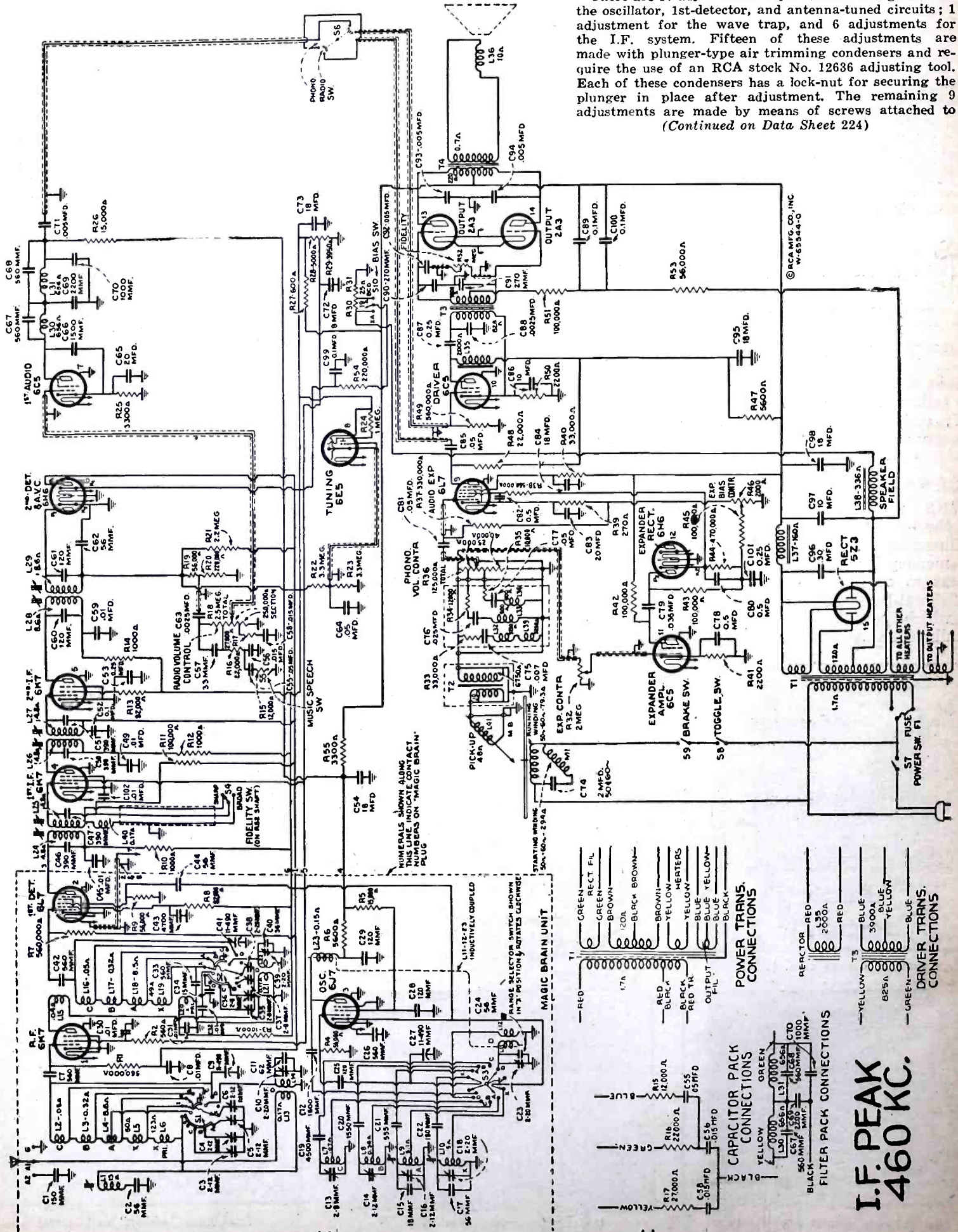

Fig. 1. Schematic diagram of the RCA-Victor model 15U receiver.

## RCA-VICTOR MODEL 15U, RADIO-PHONOGRAPH

(Continued from Data Sheet 223)

molded magnetite cores. These cores change the inductance of the particular coils in which they are inserted to provide exact alignment. All of these adjustments are accurately made during manufacture and should remain in proper alignment unless affected by abnormal conditions of climate or purported alterations for servicing, or unless altered by other means. Loss of sensitivity, improper tone quality, and poor selectivity are the usual indications of improper alignment. Such conditions will usually exist simultaneously. Correct performance of this receiver can only be obtained when these adjustments have been made by a skilled service engineer with the use of adequate and reliable test equipment.

Two methods of alignment may be used; one requires use of the cathode-ray oscilloscope, and the other requires a voltmeter or glow-type indicator. The cathode-ray alignment method is advantageous in that the indication provided is in the form of a wave-image which represents the resonance characteristics of the circuit being tuned. This method is preferred because of the I.F. characteristics of these receivers.

### I.F. ADJUSTMENTS

(a) Set "Fidelity" control to counter-clockwise position, "Radio-Phono" switch to "Radio," and "Range Selector" to "Standard Broadcast" band. Connect the "Ant." output of the test oscillator to the control-grid cap of the 6K7 second I.F. tube (with grid lead in place) through a .001-mf. condenser, with "Gnd." to receiver chassis. Tune the test oscillator to 460 kc. and place its modulation switch to "On" and its output switch to "Hi."

(b) Turn on the receiver and test oscillator. Increase the output of the test oscillator until a deflection is noticeable on the oscilloscope screen. The figures obtained represent several waves of the detected signal, the amplitude of which may be observed as an indication of output. Cause the wave-image formed (400-cycle waves) to be spread completely across the screen by adjusting the "Horizontal Gain" control. The image should be synchronized and made to remain motionless by adjusting the "Sync." and "Freq." controls.

(c) Adjust the 2 magnetite core screws L29 and L28 (see Figs. 4 and 5) of the 3rd I.F. transformer (1 on top and 1 on bottom) to produce maximum vertical deflection of the oscilloscopic image. This adjustment places the transformer in exact resonance with the 460-kc. signal.

(d) The sweeping operation should follow using the frequency modulator. Shift the oscilloscope "Timing" switch to "Ext." Insert plug of frequency-modulator cable in test-oscillator jack. Turn the test-oscillator modulation switch to "Off." Turn on the frequency modulator and place its sweep-range switch to "Hi."

(e) Increase the frequency of the test oscillator by slowly turning its tuning control until 2 separate, distinct, and similar waves appear on the screen. If only 1 wave appears, increase the "Freq." control on the oscilloscope to obtain 2 waves. These waves will be identical in shape, totally disconnected, and appear in reversed positions. They will have a common base line, which is discontinuous. Adjust the "Freq." and "Sync." controls of the oscilloscope to make them remain motionless on the screen. Continue increasing the test-oscillator frequency until these forward and reverse curves move together and overlap, with their highest points exactly coincident. This condition will be obtained at a test-oscillator setting of approximately 575 kc.

(f) With the images established as in (e), re-adjust the 2 magnetite core screws L29 and L28 on the 3rd I.F. transformer so that they cause the curves on the oscilloscope screen to become exactly coincident throughout their lengths and have maximum amplitude.

(g) Without altering the adjustments of the apparatus, shift the "Ant." output of

the test oscillator to the grid cap of the 6K7 1st I.F. tube (with grid lead in place), through a .001-mf. condenser. Regulate the test-oscillator output so that the amplitude of the oscilloscopic image is approximately the same as used for adjustment (f) above.

(h) The two 2nd I.F. transformer magnetite core screws L27 and L26 (one on top and one on bottom) should then be adjusted so that they cause the forward and reverse curves to become coincident throughout their lengths and have maximum amplitude.

(i) Without altering the adjustments of the apparatus, shift the "Ant." output of the test oscillator to the input of the I.F. system, i.e. to the grid of the 6L7 1st-detector (with grid lead in place), through a .001-mf. condenser. Regulate the test-oscillator output so the amplitude of the oscilloscopic image is approximately the same as used for adjustment (h) above.

(j) The two 1st I.F. transformer magnetite core screws L25 and L24 (1 on top and 1 on bottom) should then be adjusted so that they cause the forward and reverse waves to become coincident throughout their lengths and have maximum amplitude.

### R.F. ADJUSTMENTS

#### "Ultra Short-Wave" Band

(b) Connect the "Ant." output of the test oscillator to the antenna terminal "A1" of the receiver through a 300-ohm resistor. Set the receiver range selector to its "Ultra short-wave" position and its dial pointer to 57,000 kc. Adjust the test oscillator to 19,000 kc. The 3rd harmonic of 19,000 kc. is used for this adjustment.

Adjust oscillator air-trimmer C23 for maximum (peak) output. Two positions, each producing maximum output, may be found. The position of minimum capacity (plunger near out) should be used. This places the receiver heterodyne oscillator 460 kc. higher in frequency than the incoming signal. Tighten lock-nut. Adjust the detector air-trimmer C39, while slightly rocking the gang tuning condenser back and forth through the signal, for maximum (peak) output. Two peaks may be found on this trimmer. The peak of maximum capacity (plunger near in) should be used. Tighten lock-nut. Adjust the antenna air-trimmer C10 for maximum (peak) output while slightly rocking the gang tuning condenser back and forth through the signal. Two peaks may be found on this trimmer which produce maximum output. The peak with maximum capacity (plunger near in) should be used. Tighten lock-nut. Check the image frequency by changing the receiver dial setting to 56,080 kc. If the image signal is received at this position, the adjustment of the oscillator air-trimmer C23 has been correctly made. No adjustments should be made while checking for the image signal.

(c) Re-tune receiver for maximum response to 57,000 kc. (not image response) without disturbing test-oscillator adjustments. Change test oscillator to 6,800-14,000 kc. range. Tune test oscillator until signal is heard in speaker (should occur at approximately 14,250 kc., 4th-harmonic of test oscillator used). Two test-oscillator settings (230 kc. apart) will produce a signal at this point. The lower frequency test-oscillator setting should be used, as this places the test-oscillator harmonic 460 kc. below the frequency of the receiver heterodyne oscillator. Tune receiver for maximum response at a dial setting of approximately 28,500 kc. (image should tune in at a dial setting approximately 27,580 kc.) without altering test-oscillator adjustment. Test-oscillator 2nd-harmonic of 14,250 kc. is used for the following check. Check calibration of receiver dial. A receiver-dial reading of less than 28,500 kc. indicates that the inductance of the oscillator secondary coil L11 is too low and should be increased. If the receiver dial reading is greater than 28,500 kc., the inductance of L11 is too high and should be decreased. If it is necessary to

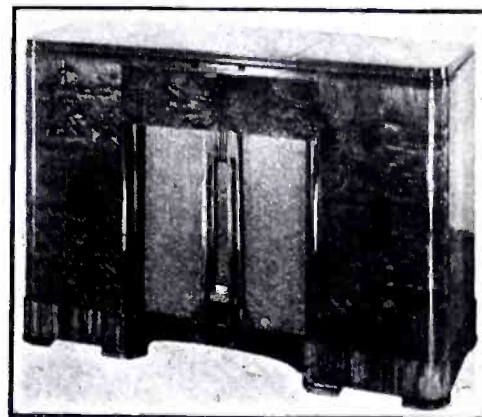

change the inductance of L11, first remove bottom cover of "Magic Brain" and then set receiver-dial pointer to 28,500 kc. To decrease inductance, move the grounded ends (straps) of L11 and L12 (see Fig. 4) nearer chassis. Do not allow straps to touch chassis except where connected. To increase inductance, move the straps farther away from chassis. Adjust position of straps until maximum (peak) output results. The alignment of the detector tuned circuit should next be checked at 28,500 kc. without changing either the receiver or test-oscillator adjustments. An increase of output when the brass end of a

(Continued on Data Sheet 225)

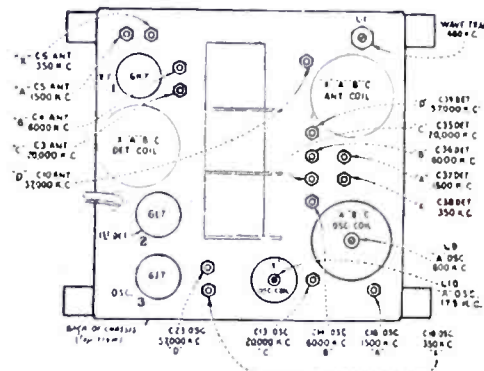
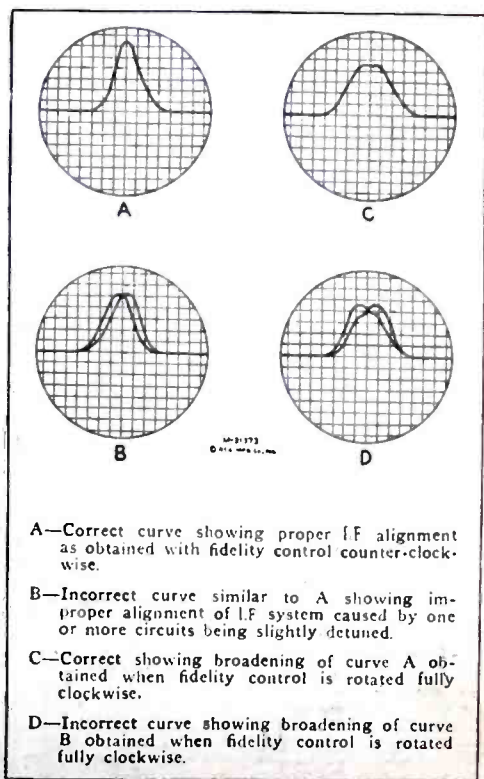

Fig. 2. Location of aligning trimmers.



- A—Correct curve showing proper I.F. alignment as obtained with fidelity control counter-clockwise.
- B—Incorrect curve similar to A showing improper alignment of I.F. system caused by one or more circuits being slightly detuned.
- C—Correct showing broadening of curve A obtained when fidelity control is rotated fully clockwise.
- D—Incorrect curve showing broadening of curve B obtained when fidelity control is rotated fully clockwise.

Fig. 3. I.F. alignment oscilloscope curves.

# READERS' DEPARTMENT

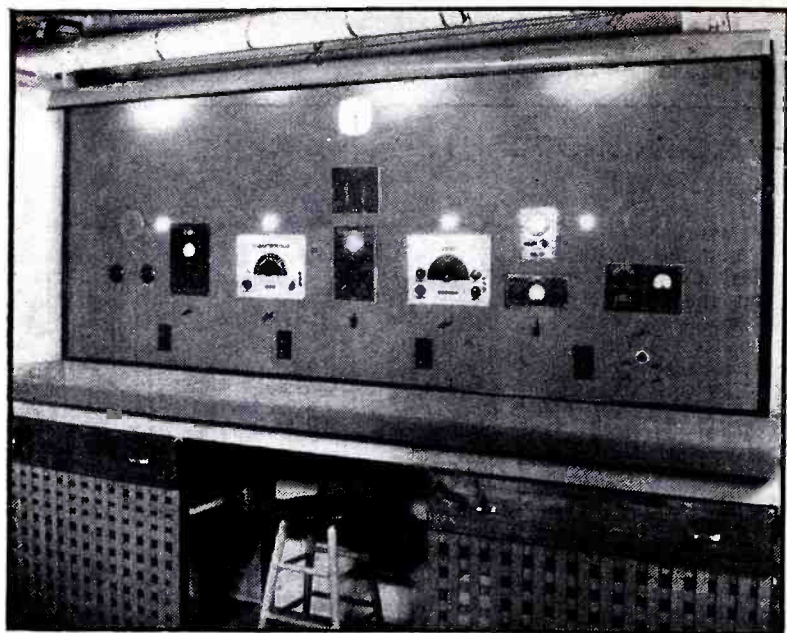

Fig. A. A modern service bench, incorporating all needed test units in a highly convenient layout.

## HANDSOME BENCH LAYOUT

Florence, Ala.:

I am enclosing a photograph (see Fig. A) of my radio testing board, in the hope that it will be beneficial to some other Service Men in planning their layouts. Following is a description of the board.

The board is made of Masonite panel, and the bench top is covered with tightly-stretched canvas which is durable and does not scratch cabinets. The indirect lighting effect was obtained by the use of several lights concealed under a piece of gutter tin.

From right to left are the speaker grille of a remote speaker for an inter-office communicating system, the master being located up-stairs (this shop is in the basement of a large store). Directly underneath is an analyzer which includes A.C. and D.C. voltmeter, ohmmeter, output indicator, oscillator, etc. (The speakers, centered at extreme right and left, hardly show in reproduction.) This is a battery-operated rig and can be slid out of the panel to carry on the job. To the left of this, bottom, is a Supreme model 111 volt-ohmmeter with ranges up to 1,200 volts. This also slides out. Directly above it is an A.C. and D.C. voltmeter, capacity meter, output meter and milliammeter. Next in line is a signal generator, A.C.-operated and mounted permanently, with frequency range of 115 kc. to 36 mc., all funda-

mentals. Next is a Supreme model 546 3-inch oscilloscope. Directly above this is a model 529 frequency modulator. These two units take their signal from the signal generator. Next in line is an audio signal generator, giving an audible signal from 60 to 11,000 cycles, and an R.F. signal of 580 kc., modulated by the variable audio frequency circuit.

Next in line is a Supreme model 85 tube checker with adapters for octal-base tubes. On the extreme left is a built-in speaker with variable field coils. As a matter of convenience on the board we also have a plug-in socket for "B" battery sets and 2-volt and 6-volt binding post terminals, an electric clock, and on and off switches for each instrument, with pilot lights in red.

The whole layout gives the radio Service Man a feeling of efficiency as well as being very impressive to the customer who is waiting. We also have, in the same room, 3 nice chairs for the customers to rest on. Other parts of the shop which do not show are filing cabinets for all service manuals, and a steel parts bin to the right of the panel.

D. K. CHAPMAN

## NOVEL CONDENSER TESTER

Melfort, Sask.:

I am a constant reader of your magazine and must say I don't know of a finer magazine for the benefit of the

service industry. I am particularly well pleased with the series of articles by Jack Grand concerning the business angle of the service game. They are both interesting and instructive. Also of interest are the many other useful and instructive articles.

I am like a great many other Service Men in respect to financial standing. For this reason I find it necessary often to get along with home-constructed instruments wherever these can be made to work. For this reason I have followed up your construction articles with much interest. I also think that if a man can build his equipment, he really has a better understanding of it.

Among other things I have tried different condenser testers and have developed one from articles published in your magazine. I submit herewith diagrams (Figs. 1 and 2) showing its construction. It is the conventional type of tester of its kind but I have added a pushbutton system for both charge and discharge of condenser. I found that it is very difficult in many cases to try to watch the bulb and try to get a set of test prods down in a set at the same time. By using this system, it is possible to clip the leads onto the condenser, then depress the button for a test. The second button provides a means of discharging the condenser back through the neon tube, giving a secondary test.

(Continued on page 719)

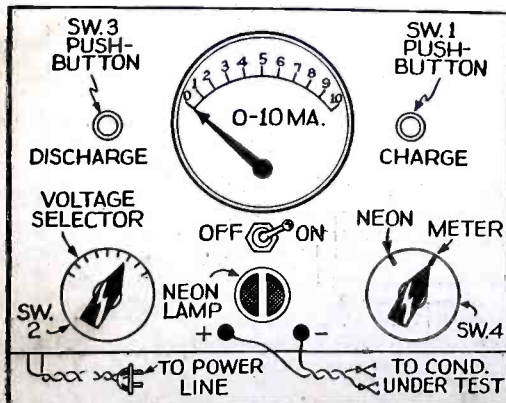

Fig. 1. Panel layout of the condenser tester diagrammed at the right. This apparatus is self-powered.

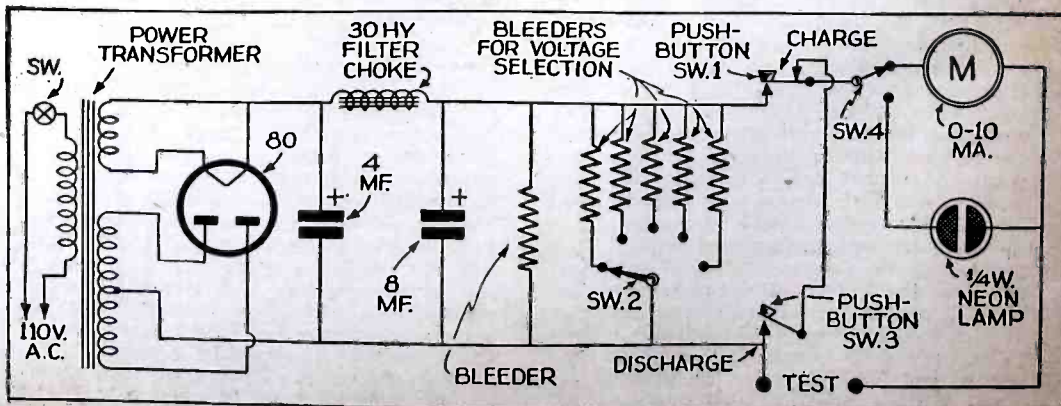

Fig. 2. Schematic diagram of condenser tester with built-in discharge button, for outside jobs.

RCA-VICTOR MODEL 15U, RADIO-PHONOGRAPH

(Continued from Data Sheet 224)

tuning wand is brought near L22 indicates that L22 is too high in inductance, while an increase when the iron end is brought near the coil indicates that the inductance is too low. The inductance of L22 may be varied by changing the spacing between the grounded end (strap) of L22 and the strap connected from C41 to contact on S2 (Fig. 4). An increase of spacing will increase the inductance, while a decrease of spacing will decrease the inductance. Adjust the spacing until maximum (peak) output results. Replace "Magic Brain" bottom cover and repeat adjustments in (b) prior to those of "Short wave" band.

"Short Wave" Band

(d) Set the receiver range selector to its "Short wave" position and its dial pointer to 20,000 kc. Adjust the test oscillator to 20,000 kc. Adjust oscillator air-trimmer C13 until maximum (peak) output is reached. Two peaks may be found with this circuit. The peak with minimum capacity (plunger near out) should be used. Tighten lock-nut. Adjust detector air-trimmer C35 until maximum (peak) output is reached, while slightly rocking the gang tuning condenser back and forth through the signal. Two peaks may be found with this circuit. The peak with maximum capacity (plunger near in) should be used. Tighten lock-nut. Adjust antenna air-trimmer C3 until maximum (peak) output is reached while slightly rocking the gang tuning condenser back and forth through the signal. Two peaks may be found with this circuit. The peak with maximum capacity (plunger near in) should be used. Tighten lock-nut. Check the image frequency by changing the receiver dial setting to 19,080 kc. The image signal should be received at this position indicating that the adjustment of C13 has been correctly made. No adjustments should be made while checking for the image signal.

"Medium Wave" Band

(e) Place receiver range selector to its "Medium wave" position with its dial pointer set to 6,000 kc. Tune the test oscillator to 6,000 kc. Adjust oscillator air-trimmer C14 to produce maximum (peak) output as shown by the waves on the oscilloscope. Two peaks may be found with this circuit. The peak with minimum capacity (plunger near out) should be used. Tighten lock-nut. Adjust the detector air-trimmer C36 for maximum (peak) output while slightly rocking the gang tuning condenser back and forth through the signal. Two peaks may be found with this circuit. The peak with maximum capacity (plunger near in) should be used. Tighten lock-nut. Adjust antenna air-trimmer C4 to produce maximum (peak) output. Tighten lock-nut.

"Standard Broadcast" Band

(f) Remove the 300-ohm resistor from between the test-oscillator "Ant." post and receiver antenna terminal "A1" and insert a 200-mmf. condenser in its place. Place receiver range selector to "Standard broadcast" position with receiver dial pointer set to 600 kc. Tune the test oscillator to 600 kc. Adjust oscillator magnetite core screw L9 (top of large oscillator coil can) for maximum (peak) output as shown by the waves on the oscilloscope screen. (g) Set receiver dial pointer to 1,500 kc. Tune test oscillator to 1,500 kc. (1,500-3,100-kc. range) and increase its output to produce a registration on the oscilloscope screen. Carefully adjust the oscillator detector, and antenna air-trimmers C16, C87, and C5, respectively, to produce maximum (peak) output as shown by the waves on the

(Continued on page 706)

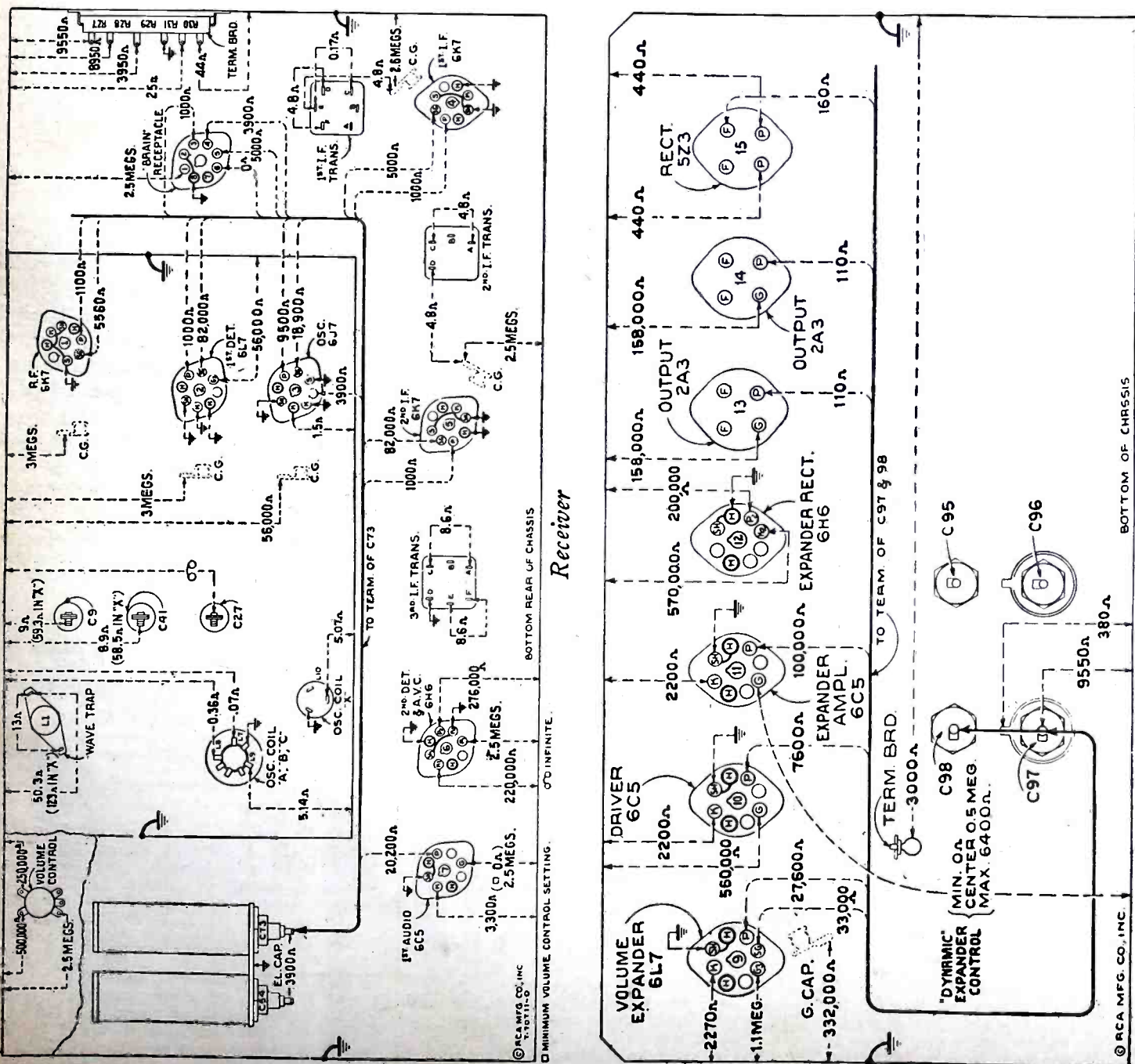

Fig. 4. Socket terminal voltages on receiver and power amplifier chassis.



Fig. A. The P.A. amplifier easily fits in the palm of the hand!

# A "HANDY" P.A. AMPLIFIER

Small enough to hold in one hand, this A.C.-D.C. amplifier will fill a hall with music! Fine for interphones, too.

GEORGE DAVEJAN

of audio output should be *uncomfortably* loud in a home.

The output of 2 watts, at least, is assured by the use of a 25L6 beam power, output tube. (See Fig. 1.) Sufficient voltage gain to drive this beam tube is obtained through the use of a 6J7 tube used as a voltage amplifier. The 25Z6 functions as a rectifier on both 110 volts A.C. and D.C. Since the types mentioned are all of the "all-metal" tube variety, it can be readily understood why the amplifier may be made so compact, since metal tubes are physically much smaller than equivalent glass types.

Concerning the layout and construction of this amplifier, little can be said about the best pro-

cedure, inasmuch as its compactness calls for crowded assembly and a certain nimbleness with the soldering-iron. However, it is reasonably possible for the average constructor to duplicate this unit, consequently a bottom view of the amplifier, showing where important parts are placed, is shown in Fig. B. Since it is desirable to minimize hum pick-up and avoid possibility of audio feedback, it is recommended that all "live" audio (plate and grid) leads that are over 2 inches in length be incased in metal sheathing. Shielding of these leads is sufficient to reduce such detrimental factors.

The operation of the unit is very simple, (Continued on page 700)

It is seldom that we run across miniature amplifiers, especially one designed for public address work, which will fit in the average man's overcoat pocket. For that reason, the unit illustrated in Fig. A at the top of this article is of unusual interest, and more so when we consider its design features.

In dimensions, it measures only 4x7x2 3/4 inches, yet on this small chassis we find all components and tubes necessary to amplify the feeble output of either crystal microphone or phonograph pickup to a full output of over 2 watts!

This output is more than sufficient to drive any good 6 or 8 inch permanent-magnet dynamic loudspeaker, so that it will fill a decent-size auditorium or home with a good quality of music or speech. To those who are not convinced, we wish to add that engineers estimate that 2 watts

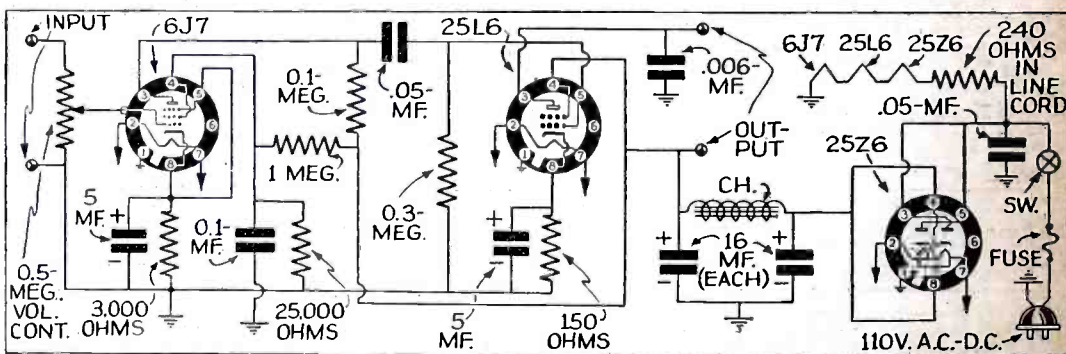

Fig. 1. Schematic diagram of the tiny P.A. amplifier.



**FREE** — A 1-year subscription to RADIO-CRAFT to each person who submits a WITTIQUIZ that in the opinion of the Editors is suitable for publication in RADIO-CRAFT. Read the following WITTIQUIZZES; can you spot the correct answers? Now send in YOUR idea of one or more good WITTIQUIZZES based on some term used in radio, and win an award. (Contest rules at end of dept.)

(52) A *bleeder* is—  
(a) An ancient barber. (b) A person who bleeds freely. (c) A resistor through which there flows a current that does not pass through the radio receiver. (d) A tax collector.

PAUL E. CLAYTOR

(53) Your dad tells you to bring him a *decade box*. Does he want—  
(a) A tool box over 10 years old? (b) A cabinet made in 1928? (c) A box containing an assembly of resistors or condensers for obtaining various values? (d) A test box in a state of decline?

ROBERT L. STEWART

(54) You have heard of a *microphone*; is it—  
(a) A thousandth part of a phone? (b) A Greek word meaning a faint sound? (c) An abbreviation for microphonograph; that is, a small, portable phonograph? (d) A device which transforms sound waves into electrical impulses? (e) A word which combines micro-of-one and means a thousandth part of one?

M. MANDELBAUM

(55) Even you know that *phone jack* is—  
(a) An interphone installed in a field for the use of jackasses. (b) A combination of switch and receptacle for quickly connecting phones to a receiver. (c) A tool used to raise telephones. (d) Money spent in a phone booth.

E. M. COYLE

(56) Do you realize that a *multivibrator* is—  
(a) An electrical trip-hammer? (b) A device for power packs that enables two or more auto-radio sets to be run at the same time? (c) An electronic arrangement for splitting frequencies? (d) A hula-hula dancer?

JOHN M. YOUNG

(57) What would you do with a *spider*?—  
(a) Step on it? (b) Cement it in the center of a speaker cone? (c) Send it to a museum?

ABE KAMPINSKY

(58) A *triode* is—  
(a) A 3-element vacuum tube? (b) A device to hold a camera steady? (c) An ode of 3 stanzas?

DON W. BICKSTROM

(59) Maybe *drycells* are—  
(a) Shriveled, withered bacteria. (b) Where a chain gang member working in a swamp would rather be. (c) A chemical method of generating E.M.F. (d) A polite name for dandruff.

S. O. HARRIES

(60) *Characteristic curves* are—  
(a) Those which you like to see at the beach. (b) What Dizzy Dean fools 'em with. (c) Graphical illustrations of vacuum tube characteristics. (d) Gradual instead of sharp bends in short-wave wiring.

GEO. K. HERMAN

(61) A *test prod* is—  
(a) What the supervisor gives the operator on watch, to see if he is asleep. (b) The part of a test kit you hold in your hand when measuring voltages. (c) The pressure you apply to a relay, to see if it is closing properly. (d) Poking a vacuum tube to see if it is microphonic.

GEO. K. HERMAN

(62) Anyone acquainted with radio knows that an *ammeter* is—  
(a) A person on Major Bowes' program. (b) The rotor of a generator. (c) An instrument for measuring amperes. (d) A meter used to record the number of times one says "am".

CHARLES W. TUNKLEY

(63) A *lug* is  
(a) An unliked, unwanted member of humanity. (b) A form of manual labor. (c) A small metal protuberance, used variously for soldering, holding or joining. (d) The mathematical representative equivalent of a number.

L. B. MCCULLOUGH, M.D.

(64) Is a *photoelectric cell*—  
(a) A prison cell where condemned men are photographed before electrocution? (b) A cell whose electrical resistance is varied by light? (c) A cell which takes photographs electrically?

D. N. KAY

(Continued on page 701)

## THE LATEST RADIO EQUIPMENT

(Continued from page 689)

requirements: (1) A high degree of frequency stability under varying external conditions, (2) a confined electromagnetic field, (3) ample output for use as a source for high-frequency measurements, and (4) a convenient physical size.

### CONVERTER MAKES ANY RADIO SET A "PUSHBUTTON" RECEIVER (1576)

HERE is a device of surpassing novelty! Any radio set without any changes in the chassis may be converted into a receiver having pushbutton tuning! Unit incorporates two tubes and 8-station pushbutton tuning.

### IMPROVED STORAGE CELLS (1577)

HIGH-POWER (881-ampere) storage cells are now available which nearly double the electric service of wind-electric and engine-power plants by supplying power during lull periods in charging. A built-in hydrometer constantly indicates the degree of charge in the cell; a built-in gauge shows water level.

### "11-TUBE" (Including 3 Ballasts) BUTTON-TUNING SET (1578)

INCORPORATES dual-range frequency band. Uses the following tubes: 1—6A7, 1—6D6, 3—76s, 2—41s, and 1—25Z5; also, 1—200R, 1—300R4, and 1—250R (these latter 3 are ballast tubes).

### AN UNDER-PILLOW CRYSTAL LOUDSPEAKER (1579)

(The Brush Development Co.)

FOR the sick-bed, or wherever individualized reception is desired, high-quality reproduction of radio programs may be obtained by using (in place of ungainly headphones) the new "Hushatone" crystal loudspeaker which slips under a pillow.

## INTERNATIONAL RADIO REVIEW

(Continued from page 677)

in a previous issue of *Radio-Craft*. Major tuning control is had through the knurled ring; the inner knob may be swung up, down, left or right as well as used in the central position and thus may be used to control "on-off" tone, volume and wave-band change. Similar centralization of control has been done with push-pull knobs and concentric shafting in sets of American make.

### ELECTRONIC ORGAN

THE "Orgatron", an air-actuated electric organ, is according to *Wireless World* (London), London's newest musical instrument. A motor-maintained vacuum vibrates metallic reeds each of which forms an element of a capacity microphone. The organ, shown in Fig. F, is less than 5 feet high and 2 feet deep; its width is 64 inches.

# SUPERIOR VALUE IN SUPERIOR INSTRUMENTS MAKES YOU WANT SUPERIOR'S TEST EQUIPMENT!

MR. SERVICEMAN—You can't afford to overlook the values in SUPERIOR'S instrument line. Such outstandingly low prices for equipment that has gained rapid popularity proves that service shops are being equipped with SUPERIOR'S stationary and portable servicing instruments. This advertisement is your buying guide . . . use it to your advantage!

### 27 Instruments in 1 THE ALLMETER 1,000 OHMS PER VOLT

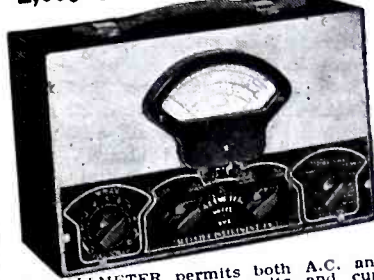

The ALLMETER permits both A.C. and D.C. measurements for volts and currents, also low resistances from below one ohm, also high resistance capacities, henries and decibels, comprising 27 instruments in one.

- 1—A.C. Currents, 15-150-750 ma. This extremely valuable service is practically never afforded by multitest instruments.
- 2—A.C. Currents, 15-150-750 volts. Affords also output meter service. Instruments, 3.
- 3—CAPACITY, .01-50 mfd., all condensers, including electrolytics. Instruments, 4.
- 4—5-1,000 Henries, coil loaded or not. Instruments, 1.
- 5—LOW ohms, .03-500 ohms. Extremely valuable. Instruments, 1 meg., covering all practical values. Instruments, 1.
- 6—HIGH ohms, 15-150-750 volts. Simplified scale uses same calibration as for fixed scale. Instruments, 3.
- 7—D.C. Currents, 15-150-750 ma. The same scale simplification, also 0-1 milliamperes. Instruments, 4.
- 8—D.C. Currents, 15-150-750 ma. The same scale simplification, also 0-1 milliamperes. Instruments, 4.
- 9—Decibels, -12 to +10. Instruments, 3 + 8 + 30 (by interpolation) + 8 + 50 by interpolation.
- 10—Vacuum-tube voltmeter, 0-15-150-750 volts A.C. D.C. Instruments, 6
- 11—Continuity tester. In instruments, 1

Shipping wt. 8 lbs. Net price . . . . . \$10.40

### THE RC BOX SOLVES PUZZLING PROBLEMS IN CAPACITY AND RESISTANCE REPLACEMENTS; ALSO USEFUL AS STANDARDS OF CAPACITY AND RESISTANCE.

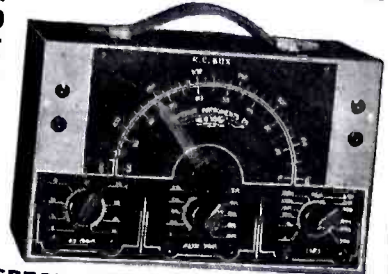

#### SPECIFICATIONS

Direct-reading, 0-40 ohms, at 10 watts maximum allowable power dissipation • Direct-reading, 0-20,000 ohms, at 3 watts maximum allowable power dissipation • Direct-reading, 0-1,000,000 ohms (1 meg.), at 1 watt maximum allowable power dissipation • Direct-reading, 10-100 mmfd. (.0001 to .0001 mfd.), at 200 peak volts allowable maximum • Direct-reading, 100-450 mmfd. (.0001-.00015 mfd.), at 200 peak volts allowable maximum • Rheostats of specially selected material for retention of calibrated values, including wire-winding of the 40 and 20,000-ohm units • Tuning condensers of exceptional quality (excellent power factor) • Two separate binding posts for each of the six different services, all clearly designated. (Rotor of two-gang condenser is common to two posts, upper left and upper right) • Accuracy is 2 per cent for all capacity settings, also 5 per cent for the 1,000,000-ohm unit • Instrument is totally shielded, so that spurious effects due to stray pickups, affecting capacity measurements particularly, are avoided. One of the common rotor posts may be used as ground when the other condenser or any of the resistors is being used. Overall size of instrument is 10 x 8 1/2 x 4 inches • Black wrinkle finish cabinet has carrying handle. Net price \$6.10

Shipping weight 4 lbs.

### VOLT-OHM-MILLIAMMETER



The HANDI-METER, a new volt-ohm-milliammeter, enables direct reading of d.c. volts 0-5/50/500, also ohms 500/20,000, likewise direct-reading, d.c. current determination to 20 milliamperes. Low ohms scale enables checking r.f. and i.f. as well as a.f. coils for shorts and opens. Low-priced instruments never before included for ohms range reading. Included low-ohms readings. Com. did they have an adjuster for accuracy of ohms readings. Complete with test leads and self-contained batteries. Shipping weight 5 lbs. Net price . . . . . \$4.10

### GENEMETER



WITH VARIABLE AUDIO FREQUENCIES

\$14.40

Complete with Four Tubes

- Combination R.F. and Audio Signal Generator, R.F. 100 KC. to 105 MC. A.F. 25-10,000 cycles, all direct reading, all by front panel switching.
- R.F. and A.F. outputs independently obtainable alone, or with A.F. (any frequency) modulating R.F.
- Output meter for connection across primary of receivers' output transformer for peaking with modulation "on".
- R.F. is subject to attenuation, and oscillation leakage is minimum.
- Condenser and other leakages tested to 100 megohms.
- Main dial protracted on 7 1/2" diameter, and 4-10-1 vernier planet drive.
- All services on 90-130 volts a.c. or d.c.

Shipping weight 10 lbs.

### MODEL V-45 TUBE TESTER

Emission type perfected tube tester for any and all type receiver tubes, including metal and metal-glass. Tests shorts and leakage. Accurate, simple, sturdy, direct

— English — reading \$10.40 (Bad-Good). . . . .

Works on 90-120 Volts 60 Cycle A.C. Shipping Weight 9 lbs.

FREE Catalog!

## SUPERIOR INSTRUMENT COMPANY

136 LIBERTY STREET

DEPT. P2

NEW YORK, N. Y.

# TRAIN FOR ELECTRICITY

## BY MY AMAZINGLY QUICK, EASY WAY

### PREPARE Today for a Real future

Whether you are 16 or 40 years old Electricity offers you many opportunities for a well paying job or a business of your own. Here in the Coyne Shops you can get a training in 12 weeks that will qualify you for your start in this fascinating opportunity field. Coyne training is practical "Learn by doing" shop training. You don't need advanced education or previous electrical experience.

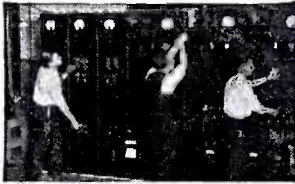

Students at COYNE operating a switchboard that controls power and light enough for a small town



No Correspondence Students testing actual converters

### Work on Actual Dynamos, Motors, etc.—Only 12 Weeks—in the Great COYNE Shops

Coyne training is not given by home study. You must come to the Coyne shops to get this training, on real actual electrical machinery and apparatus. You are trained on real Dynamos, Motors, Generators, etc., all in full operation.

### I'll Finance Your Training



Get your training first. Then take 18 months to pay for it in easy monthly payments starting 5 months after you start school. Send coupon today for all details of this plan. *H. C. Lewis*

### Earn While Learning EMPLOYMENT HELP AFTER GRADUATION

If you are short of money and need part-time work to help pay living expenses while training, my Employment Department will help you get a part time job. After graduation they will give you Free Lifetime Employment Service.

### Here is Proof of COYNE Training

"Two weeks after leaving school I took wiring job," says E. D. Berndt, "profits paid for entire course"! You would be amazed at the number of such enthusiastic letters we receive from graduates praising COYNE results.

### Included NOW — Diesel Engines Refrigeration, Air Conditioning

This extra Training without extra cost is included with your regular training if you enroll now.

### FREE! Send today for the Big Free Coyne book. With it I'll send you all the facts of Coyne training and special features.



FILL OUT THE COUPON and SEND it before another day of your life slips away from you!

**RUSH COUPON FOR FULL FACTS**  
 H. C. LEWIS, President  
 COYNE ELECTRICAL SCHOOL, Chicago, Ill.  
 Dept. 48-78, 500 S. Paulina St., Chicago, Ill.  
 Dear Mr. Lewis: Send me your Big Illustrated Catalog and details of your "Pay-After-Graduation" Offer.

Name..... Age.....  
 Street..... City..... State.....

20 SECONDS THAT MAY BE THE UPTURNING POINT IN YOUR LIFE!

## THE RADIO MONTH IN REVIEW

(Continued from page 663)

### RADIOLEGAL

THE lawmakers pursue radio with their customary assiduity. Not only was there the aftermath of the Affaire West, but here and abroad the Solons proposed more measures.

In Tokio, for example, a new penal offense was defined in a law enacted last month. It consists of "Offensively loud playing of the radio, musical instruments, phonographs, and religious drum beating."

In Laramie, Wyoming, the city council passed a law making it unlawful to cause interference to radio reception at any hour of the day or night, according to *Film Daily*. Offenders will be tracked to their lairs by means of "static locators".

### RADIO MISCELLANY

RADIO Parts City will be a feature of the 1938 National Radio Parts Trade Show, to be held in Chicago in June.

Five years ago the U. S. Forest Service fire

be done to a naughty program slipping over the heavily guarded borders from Vermont or Connecticut.

Two weeks later a blast against censorship was released by some persons who accused WMCA of cutting off Rep. Hamilton Fish in the midst of a blast against dictatorships. Explanation was that Communists in the audience had booed so loudly that Fish was muted, and that the committee sponsoring the broadcast had requested the cut-off.

At press time, the battle was in a lull. Miss West seems to have scored top honors in the whole mess. She derived publicity of a sort just prior to the opening of her new picture—and "any publicity is good publicity".

Asked whether she was responsible for the script that started things, she told a United Press reporter that she had read it and made one alteration in it. Instead of addressing the Snake as "long, black and slimy", she chose the milder term of "long, black and slinky".

Which seems just about as important as any statement yet made concerning radio's first cause célèbre.

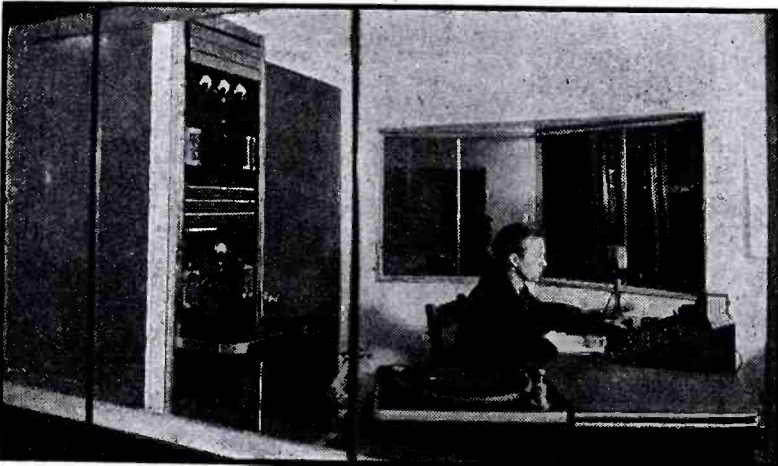

One of the control rooms of the well-known Canadian station, CKCK, which recently opened a suite of modernistic studios and placed in operation a new, 1,000-W. transmitter, exactly doubling its former power. Shown, left, are the speech input and transcription units. The improvements represent an investment of \$85,000.

View through another of the new control rooms of the Regina (Sask.) station, CKCK. Here we see the ultra-modernistic control console and additional transcription tables. All of the studios of this modern station are of the "floating" construction. That is, there is a room within a room, supported on thousands of springs! The entire setup is absolutely vibration-proof.



As described on page 698, St. Vincent's Hospital patients helped make radio history, recently, when they witnessed marionettes perform to broadcast script. Here you see the little figures, as the enthralled audience saw them, cavorting as dictated by remote MetOpera voices.



Here we are backstage. And so we see how two young ladies, trained in the art of "marionetteering", dexterously manipulate the many strings that cause the little figures to act out the parts as instructed by the "reader" at left.

Please Say That You Saw It in RADIO-CRAFT



fighters had 300 short-wave transceivers; today they have 2,300. Sets weigh as little as 8 pounds, yet have ranges from 10 to 50 miles.

Courses in television are being offered by RCA Institute and New York University. The latter has another course in amateur radio.

The Radio Manufacturers' Association is attempting to get Congress to repeal the 5% tax on radio equipment, or to reduce it to 2 1/2% or 3%. The RMA reports that government officials seemed "interested and sympathetic".

Psychologist announces Americans are getting "super-announcer voices", the symptoms of which are loud tones, intended to be heard above the blaring of the radio. Remember when they said people had to talk too loudly to be heard over the rumbling of the horse-cars?

NBC, CBS and MBS have added some \$2,000,000 per year to program budgets. This will afford additional employment for some 1000 musicians.

WOR, New York key of the MBS, is installing an ultra-high frequency transmitter, to be known as W2XJI, on the 44th floor of the building it occupies.

Transceivers for autos, to sound warnings audible only to other motorists, have been patented. Set will act as receiver until button is pressed, when warning wave will be radiated to all cars within range. Idea may help pedestrians' nerves, but as direction of source of sound will always be the same (i.e., from loudspeaker) it should not be as good as present horns for motorists.

Another auto idea is predicted by Dr. Millar McClintock, of Harvard, who says that cars will be taken over by radio control at bad turns and thus steered safely around. He also foresees transceivers in all cars to warn each of another's approach at intersections. He added that this is far in the future, a fact which no one disputed.

A new teletypewriter, developed by International Business Machine Corp., transmits by means of radio waves, sending and receiving at the rate of 100 words per minute. It is considered a threat to Teletype.

(Continued on page 698)



The new RCA model D-1 1,000-watt transmitter used at station CKCK, Sask., Canada. All components are enclosed in modernistic steel cabinets as shown.

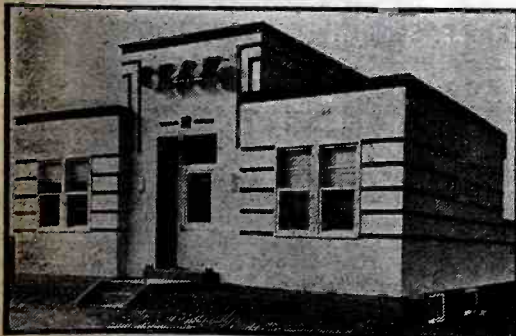

Modern to the last detail is this home for the new 1,000-W. transmitter of station CKCK. It is located on Victoria Plains, 7 miles from the studios in Regina, Sask. A 257-ft. antenna tower, built of wood to prevent power leakages, stands 400 ft. away. The vertical, copper-wire antenna is tower-high. Eight and one-half miles of copper wire was buried in the adjacent soil to serve as an efficient ground system.

GET YOUR NEW GUIDE TO RADIO! SEE EVERY NEW DEVELOPMENT

# ALLIED'S NEW CATALOG

for Spring and Summer



PACKED WITH NEWS FOR EVERY RADIO MAN!

Now Ready!

164 PAGES



NEW SETS!

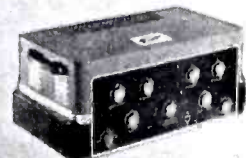

NEW SOUND SYSTEMS!



NEW HAM GEAR!

NEW KITS!  
NEW TESTERS!  
NEW PARTS!

Everything New in Radio!

Just off the press! ALLIED'S new Spring and Summer Catalog. 164 pages packed with everything new in radio. Whatever your radio interests, you'll want this new book. It's the outstanding Radio Buying Guide with comprehensive listings of Radio sets, parts, sound systems, kits, test equipment, Amateur gear, tools, books, etc., for every purpose. All leading lines of highest quality—arranged for easy reference.

Volume sales and economical merchandising mean that ALLIED can buy in huge quantities and pass the savings on to you. Everything regularly stocked under one roof. A speed-minded organization ready to serve you. That's why you get more for your dollar at ALLIED—why you save time, money, and effort on every order from ALLIED'S Catalog. Send coupon now for new Spring and Summer edition.

**Dealers!** See "America's" greatest set values! 62 new Knights, Electric Push-Button-Tuning at \$19.95!—auto radios \$14.95!—sets under \$10—new Phono-radios, Portables, Farm, Hush-a-Tone, Remote Control, models for every purpose; 5-16 tubes, AC, AC-DC, 6-volt, 32-volt, Battery, Auto—big profits for you. See them!

**Service Men!** See the latest tube-checkers, set-testers, analyzers, oscillographs, meters! All standard lines—new Hickok, Triumph equipment—at lowest prices! Over 12,000 parts, books, tools, etc.—every service need—send Coupon!

**Sound Men!** See amazing new P.A.—new features, styling, convenience—Knight Integrated systems, 10 to 80 watts—new power stage units, portable cases, mobile units, phono-players, etc.—send Coupon!

**Amateurs!** See the new transmitters, receivers, transceivers—all standard lines—new Hallcrafters, Howard Communications Receivers, RTL Hi-Frequency, RCA Television Tubes, new Transmitter Kits—send Coupon!

**Set Builders!** See Radio's largest Kit selection—many new types, Electric Fence-Control kit, Transmitter Kits, etc. We supply matched kits for any circuit in any magazine—write for Free Parts Lists.

FREE SEND COUPON

Allied Radio Corporation, Dept. 2-D-8  
833 W. Jackson Blvd., Chicago, Ill.  
 Send me your new Spring-and-Summer Catalog FREE.

Name .....  
Address .....  
City ..... State .....

## ALLIED RADIO CORP.

833 W. JACKSON BLVD., CHICAGO, ILL.

## Be a RADIO EXPERT—Learn AT HOME

### RADIO SPECIALISTS NEEDED

Modern receivers with their complicated circuit systems have knocked out the old time cut-and-try radio fixer. Trained men with up-to-the-minute knowledge are needed to service these new sets.

### HERE IS YOUR OPPORTUNITY

Your possibilities of making money and getting ahead are limited only by your ability and skill—but you must know more than the other fellow. You must be a radio service specialist, as R.T.A. can train you.

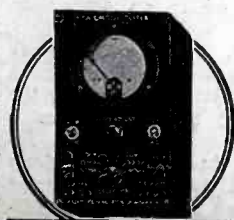

FREE OF EXTRA COST

To start you making money without delay we equip you with this Circuit Analyzer and Point-to-Point Resistance Tester.

### PRACTICAL TRAINING AT HOME

Our home study course is practical "shop and bench" training combined with a thorough set of practical lessons prepared by an experienced Radio service engineer. Four working outfits are also furnished.

### MAKE SPARE TIME MONEY

Our training is complete and practical. We show you how to make money almost from the start. The course can easily be made to pay its own way. Investigate now, write for free book of details.

### WHAT R.T.A. STUDENTS SAY

Norwood, Ohio  
I have connected with a large firm as Radio Service Manager and wish to extend my thanks for your help.  
Joseph Raplen, Jr.

Yorkville, Ohio  
From Aug. 1 to Dec. 7, 1936, I repaired 183 radios and put up 43 aerials which is very good for part time work while studying your course.  
Chas. Koerber.

RADIO TRAINING ASS'N OF AMERICA  
Dept RC-48, 4525 RAVENSWOOD AVE., CHICAGO

Please Say That You Saw It in RADIO-CRAFT

# Hear the New Scott Sixteen

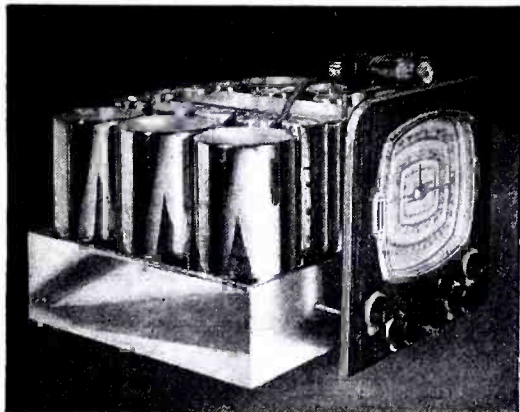

A scientific, precision instrument, custom built BY HAND, from the finest materials, in one of the world's foremost radio Research Laboratories. It represents the results of 14 years constant developing, perfecting, inventing years of intense specialization in producing the finest radio receivers. Sold with a money-back guarantee to outperform mass-produced radios. Yet, this amazing instrument costs no more than many production-type receivers.

## COMPARE THESE FEATURES

- Selectivity 10 Kc. at 37 times field strength
- Frequency Range 30 to 7,500 cycles plus or minus 5 db. continuously variable
- Continuously Variable Bass Bi-Resonator System which does not impair high frequencies
- Two Automatic Gain Control Systems
- Adjustable Sensitivity Control
- Three Stage I.F. Amplifier (Scott Patents Applied for)
- Sensitivity 0.6 microvolts
- Inverse Feedback System
- Five Year Guarantee
- I.F. Band-Pass System (Scott Patents Applied for)
- One Stage R.F. Amplification
- High Fidelity Loud Speaker with curvilinear cone and high frequency sound diffusion
- Finished in permanent mirror-finish chromium
- Super-shield Antenna Coupling System (Scott Patents Applied for)
- Signal-to-noise ratio at 2 microvolts input, 5-1
- Weakest signal providing good tuning indication—under 1 microvolt
- A.G.C. action within plus or minus 10 db. from 0.6 to 2,000,000 microvolts
- Automatic Sensitivity Compensation for each wave band
- Many other equally advanced features.

## THIRTY DAYS' HOME TRIAL!



and Budget Payments anywhere in U.S.A. NOT SOLD THROUGH STORES. Laboratory built on order only. Mail the coupon for special offer during next 30 days.

## • SPECIAL LIMITED OFFER! • MAIL COUPON FOR ALL DETAILS

**E. H. SCOTT RADIO LABORATORIES, INC.**  
4404 Ravenswood Ave., Dept. 24F8, Chicago, Ill.

Send all the facts, order blank, and Special Offer. No obligation.

Name .....

Address .....

City & State .....

**STUDIOS: NEW YORK, CHICAGO,  
LOS ANGELES, LONDON**

## INDIA'S NEW NETWORK OF RADIO BROADCASTING

(Continued from page 670)

broadcasting stations operating an international service.

### DIRECT AND INDIRECT "RAY" SERVICE

The distinction which has previously been drawn between the use of medium wavelengths and short wavelengths for broadcasting in India is based on the principle that the technically "perfect" broadcasting service can be given only by use of the "direct ray". The range of the direct ray on the medium wavelengths is, however, small, especially in India, where severe atmospheric conditions are present for large periods of the year. In actual fact the area which will be covered by a first-grade direct-ray service when all the medium-wave stations envisaged in the development program are in operation will be approximately 2% of the total area of India. The fundamental importance of the short-wave, indirect-ray service is therefore very evident.

It may be asked why indirect-ray transmission is not satisfactory on the medium waves. In Europe good long-distance, indirect-ray reception is sometimes obtained, but this is possible only because of the relative absence of atmospheric disturbances. These depend upon wavelength and their strength is, in general, proportional to wavelength: the shorter the wavelength, the less the atmospheric disturbance. It is desirable, therefore, to choose as short a wavelength as possible to avoid atmospheric disturbances, and this is limited only by the intervention of the phenomenon of "skip distance".

### SETS FOR VILLAGE ARE PADLOCKED!

An unusual requirement in receiving-sets for India which deserves special mention is provided for by the special receivers that have been developed by the Research Department of All-India Radio for community reception in Indian villages. These receivers are mounted in metal

cases and padlocked. No controls appear outside the box. The receiver is left tuned to the local station. A clockwork time-switch mounted in the box turns the set on and off at the correct time for the "Village Hour". The only attention required is a visit once every 3 weeks, when the car-type storage battery which operates the receiver is changed and the clock rewound.

Village-receiver schemes are now in operation in the service areas of each of the existing medium-wave stations, and a number of new projects will come into existence as soon as the new stations are in operation. (The foregoing material was supplied by Radio Press Service, Paris, France.)

### THE 8,000-V. RECTIFIERS

The new rectifier, which constitutes such a major contribution to the efficiency and effectiveness of the All-India Radio system, is the cover-subject for this month's issue of *Radio-Craft*. This tube has a far lower internal resistance (and, therefore, higher efficiency) than the vacuum rectifiers customarily employed. This feature also makes its cooling less of a problem.

Figure 1A is a view of the tube pictured in Fig. A and on the cover and shows the essential elements. A schematic representation of the tube, and the means by which the rectifier can be controlled and regulated without making or breaking any mechanical contacts in the high-tension circuit, are shown in Fig. 1B.

One weakness of the tube was its liability to "backfire" under certain conditions, when the glow-discharge arcs over. This is remedied by placing the anode and cathode in separate chambers, with a third chamber between them. The mica "lampshade" above the tube keeps the upper chamber warm and prevents the condensation of mercury vapor at the anode which, incidentally, is made of graphite, a material which has low thermal emission.

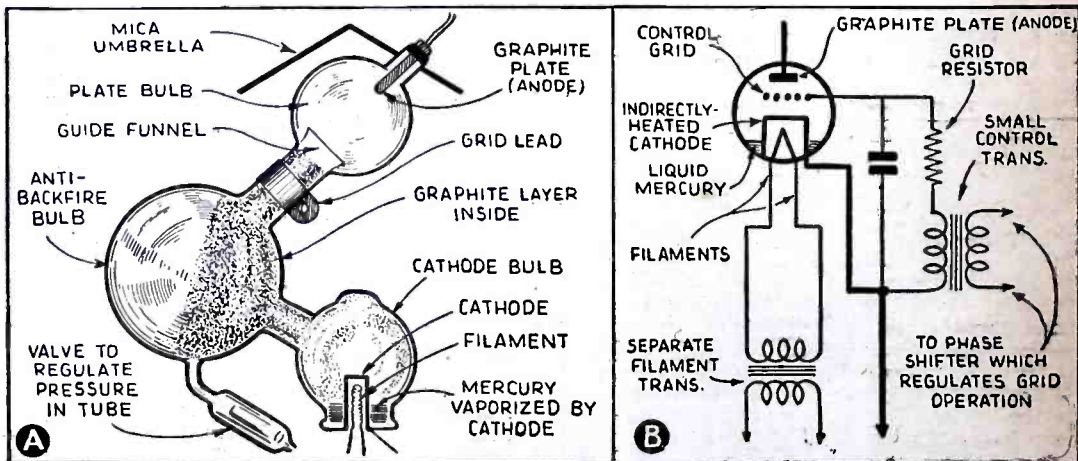

Fig. 1. At A, pictorial view and at B, fundamental circuit of the Philips 8,000-V. rectifier.

## THE RADIO MONTH IN REVIEW

(Continued from page 697)

### RADIOODDITIES

JOSEPH BARCLAY, of East Bethany, Pa., carries a 6-tube radio set on his bicycle, to entertain him on a 50-mile ride awoing, Sundays.

Accused burglar John Perez, prowling a roof, tripped over an antenna, fell with a crash. Alarmed tenants phoned police, who found, they claim, \$1,500 worth of stolen jewels in John's car.

At St. Vincent's Hospital, N. Y., patients see as well as hear during the Metropolitan Opera broadcasts. Sound is brought by radio in the usual way; sight by using marionettes on a 5-foot stage.

Leopold Stokowski, now in Hollywood, feels that "forthcoming musical films won't sound right on the screen and the public will be dissatisfied" unless, he estimates (according to a U.P. report), about 18,000 first-class musicians are eventually employed to control the sound equipment. Walt Disney's Mickey Mouse picture "Sorcerer's Apprentice" started the ball rolling. Projection-booth monitoring, Mr. Stokowski points out, is outmoded!

## NEW CIRCUITS IN MODERN RADIO RECEIVERS

(Continued from page 678)

point where signal voltages can cause substantially no diode plate current change.

### (5) I.F. SENSITIVITY CONTROL

Garod Model L-311. In addition to the conventional audio control of volume as applied to receivers equipped with A.V.C., this receiver is provided with a sensitivity control in the I.F. circuit. As in Fig. 1E, it is a shunt-type cathode or bias control. The I.F. tube is a super-control type so that the wave shape will not be seriously distorted anywhere in the negative grid section of its characteristic above cut-off. As the mutual conductance of the tube is lowered with increased bias, its gain is lowered accordingly and a large sensitivity range is thus secured. Providing that the maximum gain of the stage is 100, the sensitivity may be changed by a ratio of 100 to 1, or 20 db., with the control. Its action closely resembles a muter or Q ("quiet") circuit.

(Comments, either directly to *Radio-Craft* or via "R.-C." to Mr. Sprayberry, concerning this important department will be appreciated and of mutual value. In what way can this department be bettered to your advantage?)

## BUILD THIS SIMPLIFIED NEON-TYPE TEST UNIT

(Continued from page 685)

### AS A KEYING MONITOR

In using the unit as a code practice set or keying monitor connect a 90-V. D.C. supply to terminals marked "D.C. INPUT", throw switch "Sw. 1" to the "ON" position, connect the headphones to terminals marked "OUTPUT" and key to terminals marked "KEY". Close the circuit by means of the key and adjust resistance R1 until a steady note is obtained, then adjust C1 and Sw. 2 until desired tone is obtained. A relay should be used in place of the key when used as a keying monitor and one must remember that this unit does not monitor the transmitted signal, only the keying.

### AS A MODULATOR; SIGNAL GENERATOR

The unit could also be used as a modulator for a radio-frequency oscillator or "signal generator", and as such would furnish a modulated signal of any frequency within the limits of the audio oscillator. In connection with a vacuum-tube voltmeter a fairly accurate response curve could be run on a radio receiver. The audio frequency should be compared with a known standard or estimated by ear in each case and the voltage at input and output for each frequency, measured with the vacuum-tube voltmeter.

The neon tube circuit will oscillate more uniformly if allowed to run for several hours, previous to the test, at twice its rated voltage.

A recommended power supply circuit is shown in Fig. 2. Since almost any well-filtered power supply may be used, however, the requisite components are not included in the following List of Parts; which includes only the components shown in Fig. 1.

### LIST OF PARTS

One Centralab variable condenser, 1 meg., R1;  
One S.P.S.T. toggle switch, Sw. 1;  
†One 5-point single contact switch, Sw. 2;  
One Solar variable condenser, 500 mmf., C1;  
One Solar fixed condenser, 250 mmf., C2;  
One Solar fixed condenser, 500 mmf., C3;  
One Solar fixed condenser, .001-mf., C4;  
One Solar fixed condenser, .006-mf., C5.

†Most Radio mail order houses can supply this item if properly identified as to title of article, issue (month) of RADIO-CRAFT and year.

## SHORT-CUTS IN RADIO

(Continued from page 681)

mounted on the front or side panel. It has a neat appearance, as it is merely an octal (8-prong) tube socket, connected as shown in Fig. 4. From 1 to 4 pairs of phones may be plugged into it; their tips just fit the contacts. Four sets of contacts on each side of the socket are connected together, and the two sets of contacts thus formed are connected to the output of the set or oscillator.

T. L. TAYLOR,  
Mills River, Alberta, Can.

### HONORABLE MENTION

**EASILY-MADE DEFLECTOR BAFFLES.**  
Small dynamic speakers can be easily made into handy, portable P.A. units by equipping them with deflector baffles made as in Fig. 5.

The speaker is housed in a small aluminum kettle by mounting it on a circular piece of board. The bell is from an old horn-type speaker.

When given a coat of aluminum paint they resemble the large P.A. units.

E. E. YOUNGKIN

### HONORABLE MENTION

**WATER-PROOFING THE TELESCOPING AUTO ANTENNA.** Remembering the disastrous results of telescoping a steel fishing pole without first drying it, when I installed a telescopic antenna on my car, I decided to prevent its corrosion.

I achieved this by placing sections of rubber tubing about 2 ins. long over the joints. The tubing must fit the thinner section snugly. The tubing keeps out the rain and acts as a squeegee when the antenna is telescoped while wet.

On the heavy-type aerial, rubber distributor terminal caps can be used to secure the same results. The sketch in Fig. 6 shows how the tubes are applied.

ROBERT FORSTER

## THE RCA TUBE TWINS SAY...



THE best evidence of the *quality* that's built into every RCA radio tube is the fact that over 300 million of them have been bought by radio users.

For better radio reception, better tone, better volume — ask for RCA radio tubes. Built by the world's foremost radio organization, RCA radio tubes offer you

the extra advantages of (1) the unmatched experience of RCA engineers in every phase of radio, (2) the unmatched research and manufacturing facilities of the only company making everything in radio.

No wonder RCA radio tubes are "the tubes of unquestioned quality"! No wonder they'll do a better job for you at low cost!

Ask your distributor, or send 10 cents to Camden, N. J., for a commemorative advertisement on RCA's television tube announcement.

RCA presents the "Magic Key" every Sunday, 2 to 3 p. m., E. S. T. on NBC Blue Network



# Radio Tubes

RCA Manufacturing Company, Inc., Camden, New Jersey  
A Service of the Radio Corporation of America.

RADIO-CRAFT for March, 1938 depicts FIFTY YEARS OF RADIO PROGRESS. It is the greatest issue of any radio magazine published. If your newsdealer no longer has copies of this big 144-page issue, send fifty cents, in cash, check or stamps, to the publishers for your copy.



D7T—High Impedance 10,000  
List Price **\$22.50**

D7—Low Impedance 30 to 50 Ohms  
List Price **\$20.00**

## The New "Clipper" Dynamic

Another American Moving-Coil Microphone, Featuring

- HIGH OUTPUT — SMALL SIZE
- RUGGEDNESS — FIDELITY
- TRIM — EFFICIENT DESIGN
- LONG LIFE — STABILITY

D7 and D7T Microphones come complete with 12½' R/J cable and Amphenol plug. Chrome finish. ⅝-27 Connector. Over-all height, 2½". Diameter, 1½". Net weight, 8½ ounces.

Request Catalogue No. 27 for Complete Details.

AMERICAN MICROPHONE CO., INC., Los Angeles, California

**BUILD  
PUSH-BUTTON TUNING  
INTO ANY RADIO**

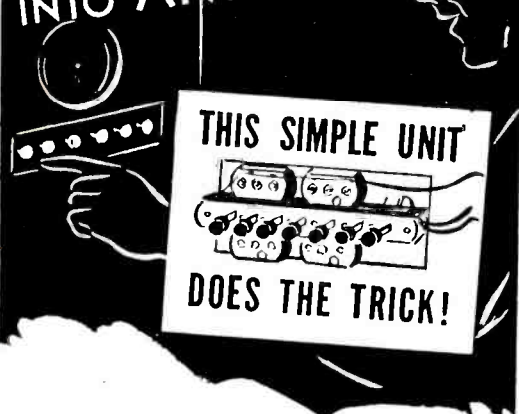

**THIS SIMPLE UNIT  
DOES THE TRICK!**

Bring old sets up to date—give them modern, push button control by simply adding a Meissner Push Button Tuner. Easily installed in any superheterodyne or TRF receiver having a two or three section Tuning Condenser—just three wires!

Provides instant selection of any of six or eight of your favorite stations—automatically—by simply pushing the button on your present radio receiver. Additional "Release" button returns your set to manual tuning. Complete instructions and full set of station call-letter discs supplied. Stations selected may be readily changed at any time if desired.

The simplicity and ease of installation of the Meissner Push Button Tuner has won the admiration of service men everywhere. It can be installed quickly at a good profit and will give unlimited service.

Try one on your own set. See your nearest good jobber or write us.

**MEISSNER  
PUSH BUTTON TUNER**

For 6 Stations	For 8 Stations
LIST PRICE	LIST PRICE
<b>\$750</b>	<b>\$950</b>

*Meissner*

**MEISSNER MANUFACTURING CO.**  
110 BELMONT AVENUE, MT. CARMEL, ILL.



**"HAM" SPECIAL** Standard Teleplex

A highly efficient code teacher using heavy specially prepared waxed paper tape, having two rows of perforations. Write for Free folder A-4. We are the originators of this type instrument

Instrument with tapes prepared by expert and complete course; all for \$11.95. Without Oscillator. 72-76 Cortlandt St., N. Y. C.

**TELEPLEX CO.**

**RADIO COURSES**

**RADIO OPERATING:** Prepare for Gov't License Exam. ● **RADIO SERVICING:** Including Short Wave ● **AMATEUR CODE** ● **ELECTRONICS** ● **TELEVISION** ●

Day and Evening Classes—Booklet Upon Request

**New York YMCA Schools**  
4 W. 64th Street, New York City

**NEW "AMPLIFIED" D.C. METER**

(Continued from page 671)

If a voltage ( $V_1$ ) from an external source is now made to appear across  $R_1$ , a voltage change ( $V_0$ ) will appear across  $R_0$  and will be registered on the voltmeter (V.M.). In equation form,

$$V_0 = V_1 \frac{(1-G)}{1+G}$$

where "G" is the voltage gain on the amplifier without the feed-back connection. If the gain is made quite large, then it is evident from the above equation that the voltage change across  $R_0$  (indicated by the meter) will be but negligibly different from that impressed across  $R_1$ . Thus, the system becomes a voltmeter with an input resistance solely determined by  $R_1$ , enabling the use of a rugged indicator (V.M.) for high sensitivities. By using a wide range of resistance values for  $R_1$ , the instrument becomes an ammeter with correspondingly wide ranges. Also, by using a standard potential and unknown resistance across  $R_1$ , the system can be calibrated as an ohmmeter.

By referring to the schematic circuit diagram (Fig. 2) it will be observed that the subject instrument is identical in principle to the system just described except for the addition of various controls including a range switch for the various input circuits used in place of  $R_1$ . R-20 corresponds to  $R_0$  and the combination of M-1 and R-21 is equivalent to V.M. S-7 is a sensitivity button which changes the meter range from 0.5 to 0.1 volt full-scale. B-7 corresponds to E; and R-15 (with variable taps on B-4) is the zero adjustment for setting the equilibrium feed-back voltage equal to that of B-7. R-12 is the megohm scale zero adjustment which, according to the specified procedure, furnishes a standard potential of 0.5 volt for resistance measurements.

The normal voltage gain "G" of the instrument amplifier is of the order of 1000, which, in the equation cited above, shows an error of 0.1% in the matching of the input and output (indicated) voltages. Thus, it is apparent that the gain may vary over fairly wide limits without appreciably affecting the accuracy of the instrument.

The operation of the amplifier is evident from the schematic diagram. The stages are directly coupled by means of the bias batteries B-1, B-2, B-3, the resistors and voltages being chosen to give proper balance over the normal range of tube characteristics and battery voltages.

For the current ranges, the various resistors corresponding to  $R_1$  are: R-4, R-5, R-6, R-7, R-8 and R-9 (respectively 5 megs, 50,000 ohms, 500 ohms, 50 ohms, 1/2 meg, and 5,000 ohms). For the voltage ranges, R-2 (55,500 ohms), R-3 (500 ohms), R-5, R-8 and R-9 are used with R-4 to obtain suitable divider circuits. In megohm measurements, R-4 is used as the "standard". The necessary "standard" potential is obtained from battery B-5, as previously explained. Precision wire-wound resistors are used in these input circuits.

Type 1B4 tubes selected at random should work satisfactorily in the amplifier. However, there is a possibility that an occasional tube may be found in which the input resistance is objectionably low (1000 megohms or less) for operation in the first stage. Because of the possibility of such resistance (due to surface or volumetric leakage, or ionic conduction), it is advisable to avoid interchanging the tubes supplied.

No routine service should be required other than checking the battery voltages occasionally, testing the tubes about every six months, and cleaning the external insulators on the binding posts. These insulators may be cleaned satisfactorily by wiping them with an unsoiled paper towel or similar unused material. Care should be taken to avoid deposit of electrolytic substances such as perspiration on the insulators, particularly for measurements at high humidities. Loss of accuracy of calibration, inability to adjust to zero needle deflection or complete failure of operation may each be due to one or more of the following causes.

- (a) Worn-out or defective batteries;
- (b) Improper location of the "zero-adjustment" taps;
- (c) Defective circuit elements or broken connections;
- (d) Defective meter.

**APPLICATION**

Numerous uses should be found for this precision instrument, particularly in engineering and research laboratories. It is ideally suited for electronic measurements and similar applications, a few of which are:

- (1) Ion and electron currents in the grid and other circuits of thermionic tubes;
- (2) Currents due to secondary emission;
- (3) Leakage currents between tube electrodes and between circuit elements;
- (4) Electron-beam currents in cathode-ray and special tubes for television purposes;
- (5) Minute currents in photo-electric cells;
- (6) Electrolysis and corrosion currents and potentials;
- (7) Galvanic currents and potentials in biological research.

The unusually high resistance of the voltmeter circuit (5 megohms or greater on all ranges) enables accurate measurement of D.C. voltage across high-impedance circuits such as those existing between tube electrodes or across circuit elements for automatic volume control, noise suppression, etc., in radio receivers. As a voltmeter, the instrument may be connected directly across grid-bias or standard-potential cells, thus permitting a direct comparison of unknown and standard potentials. The instrument also is particularly advantageous for resistance measurements in that over the total range of 0.1 to 1000 megohms, no more than 0.5 volt D.C. is ever applied across the unknown.

*This article has been prepared from data supplied by courtesy of RCA Manufacturing Company, Inc.*

**A "HANDY" P.A. AMPLIFIER**

(Continued from page 694)

since the power switch is ganged to the volume control. The input connections, it will be noted, are made directly to the grid of the 6J7 tube, and hence is of high impedance. Consequently, only high-impedance pickups or microphones should be connected to this source; in other cases a suitable matching transformer is obviously necessary.

*This article has been prepared from data supplied by courtesy of Try-Mo Radio Co.*

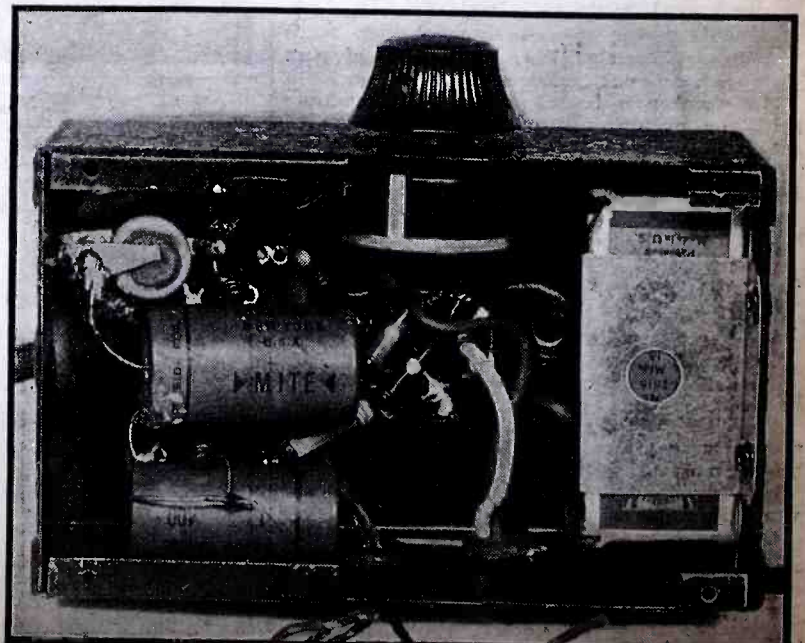

Fig. B. (Right) Underside view of the tiny P.A. amplifier.

## A DIRECT-READING ELECTRONIC "FLUX" METER

(Continued from page 680)

coil rests in the space between the poles of a horseshoe magnet. It is easy to recognize that any change in the field strength of the horseshoe magnet (or loudspeaker gap) will cause a variation of the value of the inductivity of the test coil, LE.

Any variation of the inductivity of the test coil will cause variation of frequency of the oscillator, V1, and thus a heterodyne or beat frequency will be delivered to the grid of the mixer tube, V5. Since the variations of magnetic field strength in which loudspeaker designers are interested are small, the beat frequency produced will be in the audio range, and by means of an audio-frequency meter which is calibrated in units of magnetic field strength (gauss) instead of the customary calibration in cycles (of the audio-frequency range), direct reading may be obtained, after amplification takes place in audio unit A.

Experts, who have made measurements with the previously used and quite clumsy method, will be more than enthusiastic about the simplicity of the new method of magnetic measurements, and, as said before, the entire radio industry will profit by this progress made possible only by the seemingly inexhaustible potentialities of application provided by the radio tube.

A simplified design of the same test unit, which will perhaps be as popular with Service Men in the near future as tube testers are today, is shown diagrammatically in Fig. 3 and pictorially in A. As the diagram of Fig. 3 indicates, only one oscillator, V1, is applied, working at about 40 meters. The tiny test coil, LE, is connected with the tank circuit of this oscillator, and causes changes of frequency. Coupled with this oscillator is a vacuum-tube voltmeter, V2, equipped with a tuning condenser, C1. Every change in frequency of the oscillator circuit must be compensated-for by adjusting C1 in order to obtain the same indication on galvanometer G. The knob of condenser C1 is equipped with a pointer which is read against a scale calibrated in gauss, the unit of magnetic field strength, from which direct readings may be obtained. As Fig. 4, indicates, the "tuning scale" has 3 ranges, and it needs no lengthy explanation to show that the condensers and coils, C1, C2 and C3, in the oscillator circuit, and the similar units, C6, C7 and C8, in the tube voltmeter circuit, V2, are used to adjust both units to the range to be measured. Range I embraces all magnetic field strengths from 100 to 3,000 gauss, Range II from 2,000 to 4,000 gauss, and finally Range III from 9,000 to 30,000.

## RADIO WITTIQUIZ

(Continued from page 694)

### ANSWERS

- |       |       |       |
|-------|-------|-------|
| (52c) | (53c) | (54d) |
| (55b) | (56c) | (57b) |
| (58a) | (59c) | (60c) |
| (61b) | (62c) | (63c) |
| (64b) |       |       |

### CONTEST RULES

(1) An award of a 1-year subscription to *Radio-Craft* will be given to each person who submits one or more WITTIQUIZZES that the Editors consider suitable for publication in *Radio-Craft*.

(2) WITTIQUIZZES should preferably be typed; use only one side of paper.

(3) Submit as many WITTIQUIZZES as you care to—the more you submit the more chance you have of winning—but each should be good.

(4) Each WITTIQUIZ must incorporate humorous elements, and must be based on some term used in radio, public address or electronics.

(5) All answers must be grouped, by question number and correct-answer letter, on a separate sheet of paper.

(6) All contributions become the property of *Radio-Craft*. No contributions can be returned.

(7) This contest is not open to *Radio-Craft* employees or their relatives.

(8) The contest for a given month closes on the 15th of the 3rd month preceding magazine-issue date.

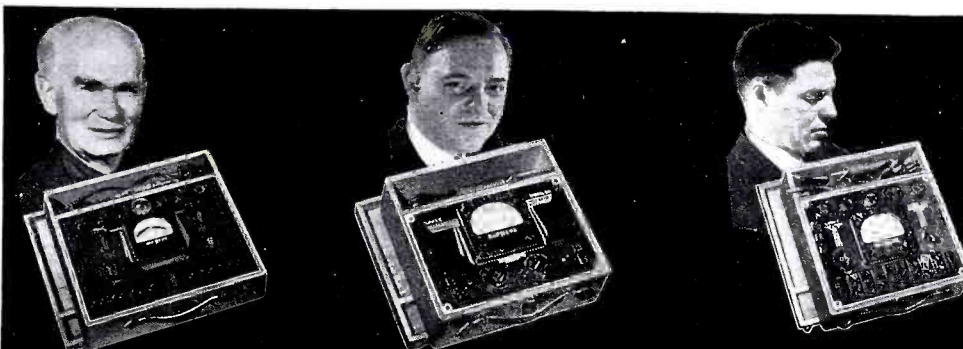

"Model 502 has almost super-human ability to separate 'Good' or 'Bad' tubes regardless of type, number of elements, or filament termination."  
LEE DE FORREST

"I am particularly glad to see SUPREME introduce so efficient and reliable an instrument as the Model 541 Set Tester."  
KARL W. MILES,  
Chief Engineer,  
The Hallicrafters, Inc.

"I was really amazed at the excellence and flexibility of Model 551 Analyzer considering its very low price."  
McMURDO SILVER,  
President,  
McMurdo Silver Corp.

## GOVERN YOUR NEXT INSTRUMENT PURCHASE BY THE OPINION OF

# Men Who Know!

Read what 6 famous radio engineers have to say of Supreme instruments! Then—see these very same instruments at your parts jobbers. Look them over carefully. Test them to your heart's content—We know you'll be a Supreme booster, too, after that!

### EASIEST INSTALLMENT TERMS!

And, remember, you can buy any Supreme instrument on Supreme S. I. C. terms—the world's easiest installment terms! See your jobber!

JUST OFF THE PRESS!

FREE ILLUSTRATED 1938 CATALOG. Write for It.

## SUPREME INSTRUMENTS CORP.

GREENWOOD, MISSISSIPPI, U. S. A.

Export Dept., Association Exporters Co., 145 West 45th St., New York City  
Cable Address: LOPREN, New York.



"Supreme is to be congratulated on the fine instrument they have built in the Model 501 Tube Tester."  
HENRY L. ARGENTO,  
Field Engineer,  
Raytheon Production Corp.

"Model 581 Signal Generator is a distinct and important contribution to rapid, intelligent and scientific radio service work."  
ALFRED A. GHIRARDI,  
Radio Technical Consultant,  
Radio & Technical Publishing Co.

"I have found that the Supreme Model 546 Oscilloscope is one of the most complete, accurate, perfectly engineered service instruments I have ever used."  
WM. L. DUNN,  
Chief Engineer,  
Belmont Radio Corp.

On page 715 of this issue appears an announcement of three new books which have just been added to the RADIO-CRAFT LIBRARY SERIES. Turn to this page NOW for complete details.

## GOOD MEN IN RADIO HAVE GOOD JOBS

There is a real future now for ambitious men in every field of Radio. But, you need something more than "good intentions." It means TRAINING NOW. Equip yourself to be able to accept the many opportunities that await men with modern training. We have the plan. Our booklet "A Tested Plan for a Future in Practical Radio Engineering" tells all. It's yours for the asking.

SEND FOR FREE BOOKLET



### CAPITOL RADIO ENGINEERING INSTITUTE

Dept. RC-4, 14th & Park Road, N. W. WASHINGTON, D. C.

## 87% OF MOVIE SOUND AND BROADCAST STUDIOS DEMAND DYNAMIC MIKES!



You can have the same dynamic microphone quality so much in demand by movie and broadcast experts who insist on "higher fidelity" . . . at a price you can afford! How? By using Transducer "Bullet" microphones. "Bullet" dynamic models are built to the rugged exacting standards of high quality telephone equipment. They challenge comparison against the field model for model. You owe it to yourself to get the best when it costs no more. Find out! Send for a free microphone comparison chart.

Priced from \$19.50 to \$90

### "BULLET" MICROPHONES

Made Only by

### TRANSDUCER CORPORATION

30 Rockefeller Plaza,

New York, N. Y.

Please Say That You Saw It in RADIO-CRAFT



HERE is the solution to the mystery of how to improve amplifier performance—and how to add Automatic Volume Expansion and Automatic Audio Volume Control to all existing amplifiers.

This new ACA Expressor can be connected in a minute to any amplifier without making any circuit changes. Self powered and operates directly from 110 volts AC.

An entirely new series of ACA Amplifiers, designed by A. C. Shaney, are now offered at lower prices than ever before. Write or wire today for complete details.

**AMPLIFIER CO. of AMERICA**  
37-47 West 20th Street New York, N. Y.

## WANT TO LEARN RADIO?

IT'S EASY...WITH Ghirardi's famous RADIO PHYSICS COURSE - ALL IN 1 VOLUME

It's as easy as A.B.C. to learn everything about RADIO, ELECTRICITY, SOUND and TELEVISION from this one big book. Ghirardi's many exclusive features and plain, understandable language make everything perfectly plain and clear, without any previous instruction. That's why Ghirardi's RADIO PHYSICS COURSE is used by more students and schools than any other radio text in the world. It's a bargain at any price—but you get it for only \$4. It's a COMPLETE course—the equal of at least 36 ordinary radio books in one.

### Here's What This Book Gives You

- Sound, Speech and Music
- Electrons
- Electric Current
- Electric Units and Circuits
- Resistance
- Ohm's Law
- Batteries
- Magnetism
- Electromagnetism
- Transformers
- Inductance
- Condensers
- Alternating Current
- Circuits
- Filters
- Electrical Measuring Instruments
- Radio Waves and Radiations
- Broadcast Stations
- Receiving Equipment
- Vacuum Tubes
- Radio and Audio Frequency Amplification
- Loud Speakers
- Battery-operated Receivers
- Power Supply Units
- Electric Receivers
- Automobile and Aircraft Receivers
- Phonograph Pick-ups
- P.A. Systems
- Short-Wave Receivers
- Photocells
- Television
- Antennas and Grounds
- Testing and Servicing Receivers
- Sound Motion Pictures
- Appendixes
- 850 Review Questions for Self-Study
- and LOTS MORE!

Mail Coupon Now! Fill it out and mail this coupon now. It gets you started in what you've always wanted to do. Get going, mister!

**\$4** 972 Pages  
508 Illustrations  
36 Chapters  
Cloth Bound

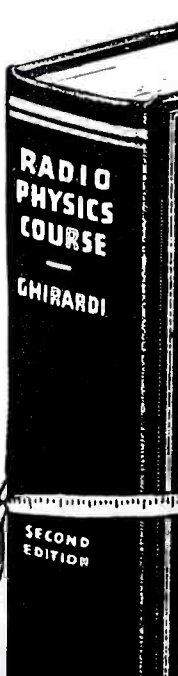

To RADIO & TECHNICAL PUBLISHING CO.  
45 ASTOR PLACE • NEW YORK

Encl. find \$4. Send my RADIO PHYSICS COURSE at once, postpaid. (Foreign, \$4.50)  
 Send me a free circular describing this book.

Name .....  
St. & City .....  
State ..... RC-48

**MONEY-BACK GUARANTEE!**

## "LEARN-BY-EXPERIMENTING" BEGINNERS' PRACTICAL RADIO COURSE

(Continued from page 688)

the current flows. This type of meter, shown, diagrammatically in Fig. 1B, though not nearly as sensitive as the moving-coil type of meter shown in Fig. 1A, has the great advantages of ruggedness and very low cost, which make it well fitted for elementary work. This type of meter is also suitable for a "roll-your-own" ohmmeter (shown in Fig. A), where the student will make his own ohms scale. Such a scale, shown in Fig. 1C, need not be of a high order of accuracy and will still be practical for a first approximation of resistance. Since the meter also has a great all-around usefulness it will not have to be discarded, if the experimenter should wish to build the more advanced type of unit later.

The principle of the vane-type meter is that of mutual repulsion between two similarly-magnetized pieces of iron. Reference to Fig. 1B shows that both stationary and movable pieces of iron are in the same solenoid. When current flows in the solenoid, the movable metal, being similarly magnetized as the fixed metal, swings on its pivot, carrying the pointer across the face of the dial. A hairspring brings it back to zero when the current ceases to flow.

The other type of meter, called the moving-coil type is the one most used by experienced radio men. In this type the swing of the needle is determined by the amount of attraction between a pivoted coil through which the current flows and a fixed permanent magnet. It is much more sensitive (and correspondingly higher in cost) than the vane-type meter.

The moving-coil-type meter (see Fig. 1A) is in reality a miniature electric motor in which motion is derived from reaction between a magnetic field and a coil of wire carrying electric current. The magnetic field is supplied by a permanent magnet.

This type of meter lends itself to combining many different types of measurements, such as volts and milliamperes in addition to ohms in one general purpose instrument. It is therefore suitable for more experienced radio students and so will here be called an advanced type of meter. Figure A shows this type meter with a factory-marked scale reading up to 100,000 ohms. By selecting this meter in the standard range of 0-1 ma. D.C. we will also be able to use it as a general purpose meter. This idea will be carried out in a later Experiment on the general use of meters, and has been provided for here by leaving room in the layout for the later additions.

With either type of meter, provision is made for obtaining full-scale deflection of the meter when the free ends of the test leads are touched together. This is accomplished by the method shown in Fig. 2A and again in Fig. 2B, where an adjustable resistor (or rheostat) is placed in series with the meter and the battery, and adjusted so that the meter reads full-scale for the battery being

used, when there is no other resistance in the circuit.

### MAKING THE SCALE

In Fig. 2B, this condition occurs when the rheostat R2 is adjusted to about 1,500 ohms. (The exact value depends upon the condition of the battery.) Let us suppose that some part, having a resistance of 1,500 ohms is now connected between the test leads. Since we now have double the resistance in the circuit (or 3,000 ohms), the meter will read 1/2 of full-scale. This reading of the meter can now be marked as 1,500 ohms. It will thus be seen that, by trying a number of accurate, known resistances, the scale of ohms can be built up.

The appearance of a completed home-made scale is shown in Fig. 1C. This was made with a vane-type meter, having a normal range of 0-6 volts, D.C. This range is a very common one (having been widely used to measure filament voltages of battery tubes). If desired, this printed scale can be used as a specimen scale, and by employing the same make of meter as specified, the resulting "roll-your-own" combination will be a very inexpensive volt-ohm-meter of the elementary type.

### PART B—RESISTANCE TESTING OF RADIO PARTS

OBJECT: To test radio parts by finding the resistance by means of a meter:

- (1) Making a "roll-your-own" ohmmeter with an inexpensive vane-type meter.
- (2) Alternative method: Using an ohmmeter of the moving-coil type.

### PROCEDURE AND RESULTS

(1) Making a "roll-your-own" ohmmeter with vane-type meter.

The parts are connected as shown in Fig. 2A. In series with the plus (+) terminal of the meter, M1 (vane type; 0-6 volts D.C.), are connected the following: resistor R1 (zero adjuster); battery (4 1/2 V.), observing its polarity; switch (Sw.); the two binding posts for the test leads, and then back to the minus (-) terminal of the meter. Turn switch on and connect the free ends of the test leads together. (Note: these may have spring clips attached to them for convenience.) Adjust the resistor so that the meter reads 4 1/2 volts (which is zero ohms on the ohms scale). Separate the two test leads and the ohmmeter is now ready for operation.

(a) Making the Scale—Test a number of known resistances by connecting each between the test leads and note position of the meter needle. Make a rough scale similar to Fig. 1C.

(b) High- and Low-Resistance Test—Test the primary and secondary of an audio transformer. Observe if the secondary shows an appreciably higher resistance than the primary.

(c) Condenser Test—Test a fixed

condenser. (This may be a mica or paper condenser having a capacity higher than 0.0005-mf., or 500 mmf.) Note the first movement of the needle due to the current charging the condenser. Continue tapping the condenser and observe if the movements of the needle disappear, showing a good condenser. If a continuous circuit is found in these types of condensers, they are rejected as unsatisfactory.

(d) **Testing Unknown Parts**—Test some part whose condition is unknown, to determine whether it is open-circuited, short-circuited, or good, that is, having approximately the desired resistance.

**Suggestion applying to classes or club groups:**

Let the teacher select three parts as unknowns; choosing, if possible, one having an open-circuit, one having a short-circuit and one good part. These are labeled simply as Unknowns 1, 2 and 3. The student then records the results for each unknown by stating whether it is open or shorted or stating the value for the resistance obtained for the good part.

(2) **Alternative Method—Using an Ohmmeter of the Moving-Coil Type.**

The parts are mounted as shown in Fig. A2 and connected as shown in Fig. 2B.

The procedure is the same as given for method (1). In this case, the meter is adjusted to full-scale reading (which is zero ohms) in order to place the ohmmeter in operation.

**CONCLUSION**

The resistance of a part may be found by connecting it in series with a battery and a meter, and measuring the current flowing. The scale of the meter may be calibrated directly in ohms, in which case, it is known as an ohmmeter.

**\*QUESTIONS**

1. When testing various resistances with an ohmmeter, the part having a higher resistance will allow: (more current; less current; or no current) to flow.

2. A part having an open-circuit, as compared with a good part, will allow: (more current; less current; or no current) to flow.

3. A part having a short-circuit, as

compared with a good part, will allow: (more current; less current; or no current) to flow.

4. The moving-coil-type meter, as compared with the vane-type meter, is (more sensitive, or more rugged and inexpensive).

5. The ohmmeter used here measures (impedance; inductance; or D.C. resistance).

\*Answers to these questions appear on Page 709.

Teachers of radio classes and club groups are invited to write to the editors concerning the use of reprints of parts of these Experiments in quantities for school use.

**LIST OF PARTS**

List for "Roll-Your-Own" Vane-Type Ohmmeter

One M<sub>1</sub>—Voltmeter (0-6 V. D.C.), Readrite;

\*One R<sub>1</sub>—Variable resistor (rheostat) 100 ohms (a potentiometer may also be used by connecting to 2 of its terminals);

†One Sw.—Switch, on-off;

†One Pair Test Leads (a two color pair, about 3 ft. long, with 2 spade lugs and 2 spring clips is convenient), Radiolab Service;

\*†One 4½ V.-Battery (a "C" battery may be used);

†Two binding posts;

One case, with holes punched for mounting parts, Radiolab Service;

†Also parts to be tested.

**Alternative List for Moving-coil Type Ohmmeter**

One M<sub>2</sub>—Volt-ohm-milliammeter (0-1 ma. D.C., 0-100,000 ohms), Triplett model 326;

One R<sub>2</sub>—Current-limiting variable resistor, 2,500 ohms tapered, Triplett, type 64;

\*†One 1½-V. drycell, intermediate size;

One case for mounting 2½-in. dia. meter;

†One switch (Sw.), one pair test leads and two binding posts as above.

\*Most Radio mail order houses can supply these items if properly identified as to title of article, issue (month) of *Radio-Craft* and year.

†Parts so marked were used in previous experiments.

**CANADA'S "INTERFERENCE DETECTIVES"**

(Continued from page 687)

The switch Sw.1 is closed on the "loop" side. The switch Sw.2 is closed either way. It is now necessary to adjust the two-gang condenser marked "Tuning" as well as the tuning dial of the receiver.

(C) "Sense," or "unidirectional" reception:

For "sense" reception, first set switches as for "Figure 8" reception and tune in signal carefully. Turn loop to position of maximum signal. Close Sw.3 to "sense" side and resistor to zero (hard left), and adjust variometer first with Sw.2 on "R" or "L". Note signal decrease at one point of variometer dial; and increase when Sw.2 is turned oppositely. Addition of resistance may improve the sense. Log all controls for sense at all frequencies.

It will be found in practice that an adjustment of the resistance in the vertical circuit will be required when the loop is in close

proximity to power lines to compensate for the relative difference in pick-up on the loop and aerial. For example, it will probably be found that less resistance is required in the vertical circuit when the loop is under a power line which has a closed grounded circuit consisting of a sky-line grounded at the poles at either side of the interference car, as this closed ground circuit increases loop reception.

The circuit is connected in such a way that when switch (Sw.2) is closed on the "R" side, the handle of the loop points to the direction from which the signal is received, for loudest signals. After the apparatus is installed in the car, this may be checked by observing the reception from a broadcast station whose location is known. If the sense indicator is reversed,

(Continued on page 711)

Please Say That You Saw It in RADIO-CRAFT

# CHATTERING VIBRATIONS

## FROM GIANT GUNS!



### BUT RAYTHEONS CAN "TAKE" IT!

The ear-splitting roar of giant guns . . . shattering vibrations that fairly rock the earth . . . these are the daily conditions under which Raytheon's tubes go through with "flying colors" in army communications!

That's because Raytheons are built *right* . . . built to stand up and "take" it! Built by the greatest engineers in the country—and with best materials available! A fact known by engineers of leading licensed set manufacturers who constantly use Raytheons as standard equipment—and by "hams" all over the world. Consider Raytheons for your rigs or replacements.

## RAYTHEON

CHICAGO      SAN FRANCISCO  
ATLANTA      NEW YORK  
NEWTON, MASS.



WORLD'S LARGEST EXCLUSIVE RADIO TUBE MANUFACTURERS



Model  
**430**

DEALER  
PRICE, Only  
**\$19<sup>80</sup>**

**Judged by the  
number in use . . .  
TODAY'S MOST  
POPULAR  
TUBE TESTER**

- HAS LINE VOLTAGE ADJUSTMENT
- HAS LEAKAGE AND SHORT TEST
- USES TRIPLET DIRECT READING INSTRUMENT (GOOD-BAD) SCALE

*Readrite*

Positively Checks All Type Radio Tubes According to Latest Recommendations of Tube Engineers. Five flush type sockets provide for all tubes. The tester operation is very simple and indicates condition of the tube for dealer and customer on Direct Reading (GOOD-BAD) colored scale of Triplet instrument. Will also test for inter-element shorts and leakages. Complete in attractive, sturdy, quartered-oak case. Sloping etched panel of silver and black. Suitable for portable or counter use.

Model 431 same as 430 except has Readrite (GOOD-BAD) Meter  
Dealer Price . . . . . **\$15.90**

**A MODIFIED EMISSION TYPE TESTER  
APPROVED CIRCUIT**

READRITE METER WORKS 416 COLLEGE AVE. BLUFETON, O.  
Please send me more information on Model 430  
Name.....  
Address.....  
City.....  
State.....

# TIME and MONEY

**SAVE BOTH WITH  
THIS GREAT CATALOG**

**HERE'S** the book that shows you how to save! 180 pages crammed full of the greatest "Buys" in radio today—parts, tubes, test instruments, ham rigs, and public address equipment, plus the famous Lafayette "line of 70" radio models for '38. In all, over 50,000 items completely described at prices you cannot beat. Write for **FREE** parts lists for any circuit described in this magazine. Send for your **FREE** copy of this catalog **NOW!**

**WHOLESALE RADIO SERVICE CO. INC.**  
NEW YORK, N.Y. • CHICAGO, ILL. • ATLANTA, GA.  
100 SIXTH AVENUE 901 W. JACKSON BLVD. 705 PEACHTREE STREET  
BOSTON, MASS. • BRONX, N.Y. • NEWARK, N.J. • JAMAICA, L.I.

**WHOLESALE RADIO SERVICE CO., INC.**  
901 W. JACKSON BLVD., CHICAGO, ILL. • 100 SIXTH AVENUE, NEW YORK, N.Y.  
(Mail to nearest warehouse)  
Rush **FREE** general Catalog No. 69-3D8  Reserve **NEW**  
**SPRING** Catalog No. 71-3D8  Send **FREE** parts lists for.....

Name.....  
Address.....  
City..... State.....

PASTE COUPON ON PENNY POST CARD

**BOOK REVIEW**

**THE PHYSICS OF ELECTRON TUBES**, by L. R. Koller. Second Edition. (1937) Published by McGraw-Hill Book Company, Inc. Size, 6 1/4 x 9 1/4 ins., cloth covers, 234 pages, 84 illustrations. Price \$3.00.

The author of "The Physics of Electron Tubes" has tried to present the subject from the point of view of a physicist in such a fashion that it would be of interest to engineers and students of physics who have no special training in electronics.

In preparing the second edition of this book the author has adhered to his original plan, namely, to present the fundamental physical phenomena involved in the operation of electron tubes and to disregard external circuit conditions. The scope and the treatment remain essentially the same as in the first edition. Mistakes have been corrected and obscure or ambiguous sections have been clarified and rearranged. In a field such as electronics in which progress has been so rapid there have been many new developments in the past 3 years and it has been necessary to add considerable new material. Sections have been added on topics such as electron optics, secondary-emission multipliers, ignitrons, and positive-ion emission. The discussions of many subjects which were given briefer treatment in the first edition have also been considerably expanded.

The chapter headings give an idea of the ground covered by this highly informative book: Theory of Thermionic Emission, Thoriated Tungsten Cathodes, Oxide-Coated Cathodes, Thermionic Emission from Caesium, Secondary Emission, Determination of Temperature, Getters and Clean-Up of Gases, Gases in Metals, Space Charge, Some Electron Tubes, Discharges in Gases.

**"PHONO PICKUPS ON PARADE"**

Clifford E. Denton, well-known sound specialist, presents in the forthcoming May issue—special **PUBLIC ADDRESS NUMBER**—of *Radio-Craft* heretofore unpublished information important to the P.A. man. Be sure to read his "Phono Pickups on Parade."

**BOOK REVIEWS**

**THE LOW VOLTAGE CATHODE RAY TUBE** And Its Applications, by G. Parr. (1937) Published by Chapman & Hall, Ltd. Size, 5 1/2 x 8 1/2 ins., cloth covers, 177 pages, 76 illustrations. Price 10s. 6d. (Exclusive American distributor, Allen B. Du Mont Laboratories, Inc.; American price \$4.00.)

Mr. Parr, Radio Division, The Edison Swan Electric Company, England, has done a first-rate job of presenting a complete cross-section of cathode-ray tube construction and use. Treatment is both theoretical and practical and hence the book becomes a valuable reference to every man in all the fields of radio in which the low-voltage cathode-ray tube familiar to most technicians may be used. There is 100 per cent value in this book (which, incidentally, is very moderately priced).

**FUNDAMENTALS OF VACUUM TUBES**, by Austin V. Eastman. (1937) Published by McGraw-Hill Book Company, Inc. Size, 6 x 9 ins., cloth covers, 438 pages, illustrated. Price \$4.00.

Discusses at length the principal types of vacuum tubes—high vacuum tubes, mercury-vapor tubes, photo tubes, and several special varieties—and the laws underlying each with engineering analyses of their more important applications. Planned to give the reader a thorough grounding in the laws governing the operation of the vacuum tube upon which he can readily familiarize himself with the details of any special application.

This book has been prepared with infinite care by the assistant professor of electrical engineering, University of Washington, and *Radio-Craft* believes it to be the most complete modern work of its kind. Anyone who takes radio seriously will want to have this book available as an engineering reference. The book includes data on the construction and use of all types of tubes under various classifications as per the following generalized grouping: Introduction, Electronic Emission, Symbols and Notations, Diodes, Triodes, Multi-Element Tubes, Photo-Sensitive Cells, Special Types of Tubes, Two Appendices on Fourier Analyses, and Authors and a Subject Index.

**SHORT-WAVE DIATHERMY**, by Tibor de Cholnoky. (1937) Published by Columbia University Press. Size, 6 x 9 1/2 ins., cloth covers, 310 pages, 38 illustrations. Price \$4.00.

Here is a book written not only for the specialist but also the general practitioner who may use short-wave diathermy alone or in combination with other classical methods of treatment. Although there are some 750 publications in the field "Short-Wave Diathermy" is the first book to furnish information from reliable sources on technique and therapeutic indication of short waves for the owners of the more than 10,000 machines estimated to be in use.

Five doctors have checked the contents of this book and Dr. Francis Carter Wood made the Crocker Research Laboratory available for experimental work. Here is a book which takes the ballyhoo out of S.-W. diathermy. The volume is divided into parts as follows: Historical Outline of Short-Wave Diathermy, The Physical Aspects of Short-Wave Diathermy, Experimentation with Short-Wave Diathermy, The Technique of Short-Wave Diathermy, The Clinical Application of Short-Wave Diathermy, Conclusion.

**TELEVISION CYCLOPAEDIA**, by Alfred T. Witts. (1937) Published by D. Van Nostrand Company, Inc. Size, 5 1/2 x 8 3/4 ins., cloth covers, 151 pages, 97 illustrations. Price \$2.25.

The alphabetical arrangement of this book made it unnecessary to include an index. Regarding its contents we quote the author's preface as follows:

"In the radio and electrical industries there are a large number of people who are keenly interested in television, yet who have not the necessary time at their disposal to be able to study the subject seriously. To these, and to keen radio amateurs, this book will prove useful, containing as it does an outline of the principles involved in the science and practice of television, presented in a manner that renders the information readily available and easily assimilated.

"The writer has endeavored to make the book as complete as possible."

Please Say That You Saw It in RADIO-CRAFT



## THE Du MONT TELEVISION SYSTEM

(Continued from page 675)

provided so that it does not interfere with the audio system. Satisfactory results can be obtained by transmitting the sawtooth sweep pulse itself or transmitting sine waves of the same frequency and converting them to sawtooth waves at the receiver by means of a simple rectifier-filter arrangement. When the receivers are to be used on the same power system as the transmitter, it is not necessary to send the frame sweep at all, as a rectifier-filter circuit at the receiver supplies the necessary frame deflection. This condition exists in well over 90% of the country, further simplifying the receiver problem in most sections.

It is believed that the Du Mont System of television is a marked improvement over present systems and eliminates the major difficulties which have been retarding the use of television receivers by the average citizen.

Laboratory workers who specialize in television research find it too inconvenient and time-consuming to attempt to design and test equipment where the image-subject is continually changing in position, lighting, etc., as would be the case if live subjects are used. Hence the development of the following interesting television-transmission device which serves the dual purpose of facilitating general television test work and of demonstrating the capabilities of the new television system.

### THE "PHASMAJECTOR"— NEW TELEVISION TERM (AND DEVICE)

The demonstrator, experimenter, designer and tester are now entirely independent of the temperamental television transmitters heretofore depended upon for video signals. Instead of waiting for days and even weeks to tune-in on the elusive television images, let alone figuring out the veritable cross-word puzzles of signals of unknown scanning techniques, the television worker now has his own signals constantly on tap and of known technique. And this is of incalculable value in accelerating further television progress.

A radically new development by the writer and his associates, the "Phasmajector" (Greek for *Image Emitter*)—a modified form of cathode-ray tube—provides a uniform television test signal with relatively inexpensive associated apparatus. In place of the usual fluorescent screen swept by the cathode-ray beam and glowing to weave an image, there is in the Phasmajector (see Fig. C) a metallic plate on which is printed the desired picture or test pattern. Also, the tube includes a collector electrode as well as the conventional cathode-ray tube gun and deflecting electrodes.

When used with proper sweep circuits and amplifiers, the picture printed on the metallic plate can be readily scanned and transmitted to a receiver for reproduction on a standard television viewing tube. It is also possible to use the standard oscilloscope cathode-ray tubes for viewing, as demonstrated by the photographic reproduction, Fig. B, of the image received on a Du Mont type 34-XH or 3-inch oscilloscope tube.

The new image-transmitting tube or Phasmajector operates on the principle of varying secondary emission from the image plate. In other words, as the cathode-ray beam scans the image on the metallic plate, varying amounts of secondary electrons are released depending upon whether the beam impinges upon metal or special ink used to print the picture. A larger number of electrons are released when the ray strikes the metal than when it strikes the ink. The varying voltage output is picked up by the collector electrode and fed to the grid of the video amplifier. This signal is very stable and of much better quality than can be obtained from a photoelectric mosaic pick-up tube because of the absence of capacity effects. The amplitude of the signal may be as high as 10 volts with high-impedance coupling and can modulate a television viewing tube directly without any video amplifier. The signal is 0.2-volt across a 10,000-ohm load.

For a simple television demonstration, two standard oscilloscopes such as are used by radio Service Men, can be employed very conveniently. One of the two oscilloscopes is equipped with a Phasmajector tube in place of the usual cathode-ray tube, and the other is utilized with its usual tube. Certain slight modifications are required, but the oscilloscopes can still be used for their normal purposes when desired. With

such a simple, inexpensive arrangement all the principles of a complete television system can be readily demonstrated. Either horizontal or vertical scanning of any desired number of lines and any interlacing arrangement can be used.

The Phasmajector Type 1 has the same operating voltages as the Du Mont 34-XH 3-inch cathode-ray tube. It has two additional electrodes, however, namely the *collector electrode* and the *image plate*. The collector is operated several hundred volts positive with respect to the anode, and feeds into the grid of the amplifier tube. The image plate is normally grounded to the anode.

The present Phasmajector available to demonstrators, experimenters and others has on its plate an excellent line drawing of Abraham Lincoln. In demonstrations recently staged at the writer's laboratories, the drawing was first scanned with a half-dozen lines or less, yet the coarse image reproduced could be at least identified. Especially so by increasing the interlacing ratio. Stepping up the scanning pattern to about 100 lines and adjusting the intensity and focusing controls, an excellent image was obtained. The individual luminous lines were observed to disappear as they overlapped and blended together. Interesting distortion could be produced at will, such as by horizontal expansion of the image, whereupon Mr. Lincoln developed an overgrown proboscis and an Ethiopian hair cut. Vertical expansion likewise produces a humorous effect, this time by way of a more than intellectual forehead and a decidedly sour expression, let alone a crop of hair that would bring joy to any hair tonic manufacturer.

### 4-TUBE "PEE WEE" T.R.F. RECEIVER

(Continued from page 683)

set to invalids; an under-pillow loud-speaker or an earphone may be rigged up with a change-over switch for personalized reception. (*Radio-Craft* suggests that the manufacturer look into this idea of incorporating a switch for this purpose.) Of course this little set also recommends itself for use in the office or as an auxiliary home set.

The set measures but 5 7/8 ins. wide by 4 1/4 ins. high and is housed in a 1-piece moulded plastic cabinet with 2-tone trimmings. A glance at the chassis shown in Fig. B shows how compactly the components are mounted.

Small as the set is, it nevertheless uses 4 standard metal tubes and a dynamic reproducer; it's selective, too.

Our Information Bureau will gladly supply manufacturers' names and addresses for any items mentioned in *RADIO-CRAFT*. Please enclose a stamped, self-addressed envelope.

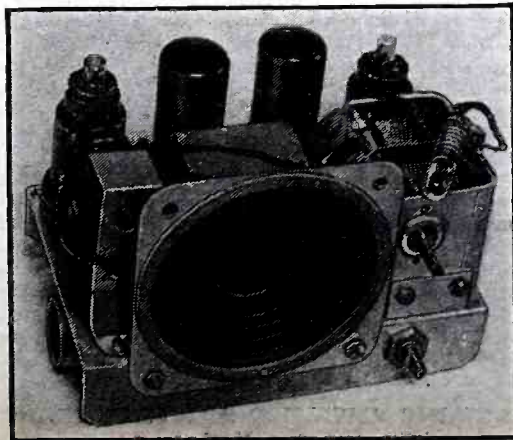

Fig. B

Please Say That You Saw It in *RADIO-CRAFT*

## STEP INTO A GOOD PAYING JOB in

# RADIO

I Can Train You  
At Home  
To Make

\$35.00  
to Per Week  
\$75.00



## I'LL PROVE IT!..

I Actually Set You Up For A  
Profitable Business

Here's the greatest opportunity you've ever had to enter the fast moving Radio industry. Tremendous money making possibilities exist for properly trained men. If you are an ambitious fellow, I can train you for a good paying full time or part time job... with a big future ahead. My training is distinctly new and different. It not only teaches all phases of Radio... It equips you fully for an actual start in your own Radio business.



### Professional Outfit Given

Positively the finest equipment offered with any Radio course is available to every Sprayberry student. Consists of All-Wave, All-Purpose Analyzer, Rider Manuals (7,070 pages), Tool Kit, Electric Eye Outfit, Experimental Apparatus.

### No Experience Needed Earn While You Learn

Sprayberry lessons are intensely interesting and easy to understand... thoroughly cover all branches and phases of Radio. Right at the beginning of your training, I show you how to get profitable spare time Radio service work. Moreover, I show you how to do these jobs efficiently. Thus you gain real practical experience and add easy cash to your bank account while you're learning.



### Don't "Wish" For More Money Train For It Now!

Wouldn't you like to be your own Boss... with a regular cash income? Why envy those fellows who have good paying jobs... who are building toward future security? They are no smarter than you. All that it takes is initiative.

### Iron-Clad Money Back Agreement

You must be satisfied that my Course is exactly as represented... or it will cost you nothing. Why not cash in now on the spare time or full time jobs waiting for properly trained men? Hundreds of fellows have made good. I cannot urge you too strongly to get started immediately in Radio.

### THESE FELLOWS Made Good... So Can You!

**Cleared \$150 in Spare Time**  
"Since enrolling I have cleared a net profit of more than \$150 in spare time alone... And I am not one-half through the course yet. Honestly, I cannot understand how you can give so much 'dope' for so little money."  
A. H. Lanole, Northbridge, Mass.

**Earns \$25 Monthly Spare Time**  
"I am now doing spare time service work as a result of your training. Make around \$25 per month installing auto Radio receivers."  
George Herrington, B. C., Canada.

**Mahoney Gets Job With Sears**  
"I found that after three months of study I was able to service sets in a much more professional manner. Business certainly showed an increase. I recently received an offer from Sears Roebuck which I could not have accepted without having had your training."  
Joseph Mahoney, Rhode Island.

### SPECIAL SERVICEMAN'S COURSE

... Of an advanced nature for men already in Radio work. Explains newest methods, circuits and short cuts. Terms low as \$3.00 per month.

GET THE FACTS!

Mail Coupon Now

Sprayberry Academy of Radio,  
F. L. Sprayberry, Pres.,  
120-D University Place, N. W.,  
Washington, D. C.

Please send me free copy of "More Money In Radio".

Name ..... Age .....

Address .....

City ..... State .....

Mail in envelope or paste coupon on postcard.  
If interested in Service Course only, check here ( )

# RCA-VICTOR MODEL 15U, RADIO-PHONOGRAPH

DATA SHEETS NOS. 223, 224 and 225

(Continued from page 693)



because of the number of curves and combinations making it possible to give my customers a perfect control at all times"

(JACK VAUGHAN)

Manager Service Dept. Broadway Dept. Store, Los Angeles, Calif.

PROUD as a peacock. Old Man Centralab adds this West Coast testimonial to the hundreds he has received from coast to coast . . . from air lines and men in the tropics. Wherever you are . . . that service job is no longer a problem if you solve it with CENTRALAB Controls and fixed resistors.

# Centralab

MILWAUKEE WISCONSIN  
BRITISH CENTRALAB, LTD.

Canterbury Rd., Kilburn  
London N.W. 6, England

FRENCH CENTRALAB CO.

118 Avenue Ledru-Rollin Paris XI, France

## Save Money on everything you buy . . .



### The New BARGAIN BULLETIN

Your Guide to Hundreds of Outstanding Values.

**FREE** Write today for this outstanding new BARGAIN BULLETIN—there is no obligation on your part. High quality merchandise at sensationally low prices! Radio Sets, Parts, Sporting Goods, Watches, Clocks, Typewriters, Cameras, Novelties and many other items at real savings to you. Fair Dealing—Prompt and Courteous Service, always. Send for your Free BARGAIN BULLETIN now, try us, and be convinced of our superior values and service.

**RADIO CIRCULAR CO., INC.**

DEPARTMENT RC

915 Broadway

New York, N. Y.

oscilloscope screen. Shift the oscilloscope "Timing" switch to "Ext." Place the frequency modulator sweep-range switch to its "Lo" position and insert plug of the frequency-modulator cable in test-oscillator jack. Turn test-oscillator modulation switch to "Off." Re-tune the test oscillator (increase frequency) until the forward and reverse waves show on the oscilloscope screen and become coincident at their highest points. This will occur at a test-oscillator setting of approximately 1,680 kc. Adjust trimmers C16, C37, and C5 again, setting each to the point which produces the best coincidence and maximum amplitude of the images.

(h) Remove the plug of the frequency-modulator cable from the test-oscillator jack. Turn test-oscillator modulation switch to "On." Set oscilloscope "Timing" switch to "Int." Tune test oscillator to 200 kc. (200-400-kc. range). Tune receiver for maximum response to this signal at a dial reading of approximately 600 kc. The 3rd-harmonic of the 200-kc. signal is used for this adjustment. Shift oscilloscope "Timing" switch to "Ext." Insert the plug of the frequency-modulator cable in test-oscillator jack. Turn test-oscillator modulation switch to "Off." Re-tune the test oscillator (increased frequency) until the forward and reverse waves show on the oscilloscope screen. This will occur at a test-oscillator setting of approximately 230 kc. Disregarding the fact that the 2 images may or may not come together, adjust the oscillator magnetite core screw L9 (top of large oscillator coil can) to produce maximum (peak) amplitude of the images. Shift the oscilloscope "Timing" switch to "Int." Remove the plug of the frequency-modulator cable from the test-oscillator jack. Turn the test-oscillator modulation switch to "On." Repeat adjustments in (g) above to compensate for any changes caused by the adjustment of L9 core, tightening lock-nuts on C16, C37, and C5, respectively, after each is adjusted.

#### "Long Wave" Band

(i) Shift the oscilloscope "Timing" switch to "Int." Remove the plug of the frequency-modulator cable from the test-oscillator jack. Turn the test-oscillator modulation switch to "On." Place receiver range selector to its "Long wave" position. Set the receiver dial pointer to 175 kc. Tune the test oscillator to 175 kc. and increase its output until a deflection is noticeable on the oscilloscope screen. Adjust oscillator magnetite core screw L10 (located on top of small oscillator coil can) so that maximum (peak) amplitude of output is shown on the oscilloscope screen.

(j) Set receiver dial pointer to 350 kc. Tune test oscillator to 350 kc. Adjust the oscillator, detector, and antenna air-trimmers C18, C38, and C6 to produce maximum (peak) output as shown by the waves on the oscilloscope screen. Without disturbing the connections, shift the oscilloscope "Timing" switch to "Ext." Place the frequency-modulator sweep-range switch to its "Hi" position and insert plug of frequency-modulator cable in test-oscillator jack. Turn test-oscillator modulation switch to "Off." Re-tune the test oscillator (decrease frequency) until the forward and reverse waves show on the oscilloscope screen and become coincident at their highest points. This will occur at a test-oscillator setting of approximately 198 kc. This setting places the test-oscillator frequency to 175 kc. The 2nd-harmonic is now used for the 350 kc. adjustment. Adjust air-trimmers C18, C38, and C6, again, to produce maximum amplitude of the images and best coincident throughout their lengths.

(k) Re-tune the receiver to approximately 175 kc. so that the forward and reverse waves appear on the oscilloscope screen. Adjust the oscillator magnetite core screw L10 to produce maximum (peak) amplitude of the waves, disregarding the fact that the 2 images may or may not come together.

(l) Shift the receiver dial setting to 350 kc. without altering any other adjustments (frequency modulator still in operation). Adjust air-trimmers C18, C38, and C6, respectively, to produce maximum amplitude and best coincidence of the waves. These adjustments compensate for any changes caused by the adjustment of the magnetite core screw L10. Tighten lock-nuts on C18, C38, and C6, respectively, after each is adjusted.

#### DYNAMIC AMPLIFIER ADJUSTMENTS

It is essential that correct voltages and currents exist at the 6L7 audio expander stage in

order that the expanding function may take place in the proper manner. A screwdriver adjustment is accordingly provided to regulate the 6L7 control-grid No. 3 bias to the correct operating value. Two methods of adjustment are applicable. Either method requires a normal voltage of 300 volts across the filter output. The simplest method is as follows:

Turn power switch off. Place RCA Stock No. 12353 Split-Plate Adapter under the 6L7 audio-volume expander. Connect a suitable D.C. milliammeter to the adapter. Turn both the "Phonograph volume" and the "Dynamic amplifier" controls to their extreme counter-clockwise positions. Turn on power switch and allow a few minutes for the instrument to become stabilized. Adjust expander bias control R46, on rear apron of amplifier (see Fig. 3), to give 1.0 milliampere of plate current with no signal input to the dynamic amplifier.

#### LOUDSPEAKER

Centering of the loudspeaker voice coil is made in the usual manner with 3 narrow paper feelers after first removing the front paper dust cover. This may be removed by softening its cement with a very light application of acetone, using care not to allow the acetone to flow down into the air gap. The dust cover should be cemented on with ambroid.

#### AUTOMATIC RECORD EJECTOR

It is important when servicing the automatic mechanism, to have it placed on a level support. It is also important to refrain from forcing the mechanism if there is a tendency to bind or jam, since bent levers and possibly broken parts may result.

The tip of the record ejector is adjustable in relation to the turntable spindle, the two being exactly coaxial when properly adjusted. To align the tip, remove the rubber silencer of the ejector assembly, loosen ejector tip retaining nut and slide the tip assembly to the position where it is in true-line with the axis of the turntable spindle. This adjustment may be simplified by placing several records on the turntable, depressing the spindle through the top record hole and lining up the ejector tip in the spindle hole of the record.

To insure that the ejector tip rotates freely, apply a slight amount of oil to the shank of the tip at the point where it is in contact with the ball bearing.

Radiotron Cathode Current Readings	
Measured with Milliammeter Connected at Tube Socket Cathode Terminal under Conditions Similar to Those of Voltage Measurements	
(1) RCA-6K7—R-F Amp.	15.0 ma.
(2) RCA-6L7—1st Det.	3.7 ma.
(3) RCA-6L7—Osc.	7.0 ma.
(4) RCA-6K7—1st I-F Amp.	5.0 ma.
(5) RCA-6K7—2nd I-F Amp.	7.5 ma.
(6) RCA-6H6—2nd Det.—A.V.C.	—
(7) RCA-6C5—Audio Voltage Amp.	2.5 ma.
(8) RCA-6E5—Tuning Tube	1.2 ma.
(9) RCA-6L7—Audio Volume Exp.	7.5 ma.
(10) RCA-6C5—Audio Driver	4.0 ma.
(11) RCA-6C5—Expander Amplifier	1.9 ma.
(12) RCA-6H6—Expander Rectifier	—
(13) RCA-2A3—Power Output	41.8 ma.
(14) RCA-2A3—Power Output	41.8 ma.
(15) RCA-5Z3—Rectifier	165 ma.*

(\*Cannot be measured at socket)

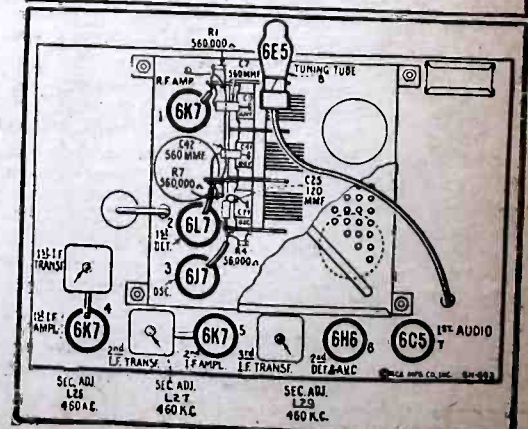

Fig. 5. Model 15U chassis showing the positions of the tuning catancomb, tubes and I.F. transformers and trimmers. See pages 690, 691, and 693 for additional service diagrams.

Please Say That You Saw It in RADIO-CRAFT

## IT'S EASY TO BUILD THIS "BROWNING-83" 4-BAND SUPERHET.

(Continued from page 673)

is not the case, as the triple-tuned I.F. circuit has the characteristic of having a very steep-sided resonance curve and, consequently, gives exceptionally good selectivity as far as adjacent-channel response is concerned.

Diode detection has been employed as well as automatic volume control. The audio system is resistance-capacity coupled and comprises a 6F5, a 6C5 and two 6F6 tubes in push-pull. The 6C5 acts as a phase-inverter. A great many circuits of this type were tried out to determine which was the most fool-proof from the standpoint of the experimenter. Many of these circuits utilize a separate tube for phase-inversion. In such cases, the resultant quality is dependent upon the amplification of the tube as well as upon the resistors and condensers used in the circuit. The circuit shown has the advantage of having only two (20,000-ohm) resistors and two (0.1-mf.) condensers which are at all critical. When the values of these component parts are within 2%, practically the same signal in reversed phase is fed to each of the 6F6 power tubes and, consequently, they are operated in a true push-pull manner. Even half the power delivered from this push-pull amplifier is sufficient for any home requirements. Should it be desired to use the receiver for auditorium or public-address systems, the 6F6's may be connected to drive 6L6's or 6V6's.

A special high-grade speaker will be available for the receiver, especially designed for the circuit requirements by Wright-DeCoster. A suitable baffle or a sound labyrinth is most desirable.

In a subsequent instalment, performance curves of the various component systems, as well as sound pressure curves emanating from the sound speaker due to a modulating radio-frequency signal being fed into the antenna circuit, will be given.

## RADIO-CRAFT'S INFORMATION BUREAU

(Continued from page 684)

were given as to how many turns to make the induction coils. I want to make one coil for long waves and two coils for short waves. Each coil has two windings. How many turns shall I make on each coil for each winding?

(A.) Your letter does not indicate which long-wave band you wish to cover. However, here are the coil values for the short-wave bands. All are calculated for use with a 140 mmf. variable tuning condenser. For 10-20 meters, primary 4 turns No. 31; secondary, 4 3/4 turns No. 22 spaced at the rate of .6 turns per inch. For 20-40 meters, pri. 6 turns; sec. 10 3/4 turns spaced 12 turns per inch. For 40-80 meters, pri. 7 turns, sec. 51 3/4 turns spaced 16 turns per inch. For 80-200 meters, pri. 15 turns, sec. 51 3/4 turns spaced 40 turns to the inch. All coils are wound on 1 1/4-inch tubing; the wire used may be either double silk covered or enameled. Primaries are separated from secondaries by 3/32-inch. If you wish to try the broadcast band, wind a 22-turn primary with a 112-turn secondary.

The diagram you show is of a very old model. The one shown in Fig. Q2-395 will afford more satisfactory results. The coil data for the 5 coils, in the same order as above, follows: primaries 4 turns, 8 turns, 15 turns, 31 turns, 64 turns; secondaries 5 turns, 11 turns, 23 turns, 50 turns, 105 turns. Space between secondary turns, 3/16-inch, 3/32-inch, 5/64-inch, 1/32-inch, 0 inch. No space between primary and secondary. Wire, D.S.C. or enameled. Primary No. 32, all coils. Secondary, Nos. 26, 26, 30, 32, respectively. On the same forms, on the other side of the primary coils, wind tickler coils: 5 turns No. 32, 7 turns No. 32, 8 turns No. 30, 16 turns No. 30, 30 turns No. 32. Spacing between primary and tickler, 3/32-inch, 3/16-inch, 3/32-inch, 5/32-inch, 5/32-inch. No space between turns. Reverse tickler (plate) coil leads, T, if circuit doesn't regenerate. The simplest way of course is to reverse these connections right at the socket; usually, the directions accompanying the coils give sufficient data regarding this item.

## EQUIP Your SHOP THE MODERN WAY...

### ...at almost no cost to you!

The ARCTURUS EQUIPMENT DEAL is unquestionably the easiest, fairest and MOST PROFITABLE plan ever offered whereby you can obtain almost any kind of shop or test equipment . . . at almost no cost to you. Get the facts. Send the coupon at once. Let us tell how we'll modernize your shop the MODERN way—how you can make your purchases of Radio's finest tubes mean greater shop efficiency and better profits in all your work.

## ARCTURUS BRINGS YOU A "NEW DEAL" IN FREE EQUIPMENT DEALS

Since the beginning of Radio, Arcturus tubes have been first choice of discriminating users. They are better engineered—scientifically constructed for better performance under all conditions. NOW the new Arcturus Equipment Deal offers you a double profit from every tube you sell by bringing you the finest servicing equipment under the fairest, easiest plan yet devised. To get the equipment you need, surprisingly few tubes need be purchased—and you get the equipment at once! Moreover, you buy Arcturus tubes at standard prices, less standard discounts. Not one cent has been added!



FEWER TUBES to BUY  
... LOWEST PRICES ...  
BETTER FROM EVERY  
PRACTICAL STANDPOINT



### YOU CAN'T LOSE! . . . ! MAIL THE COUPON TODAY!

ARCTURUS RADIO TUBE CO. C-4  
Newark, N. J.  
Without cost or obligation on my part, send details of your new equipment deal.

Name \_\_\_\_\_  
Street \_\_\_\_\_  
City \_\_\_\_\_ State \_\_\_\_\_  
 I am a dealer  I am a serviceman  
My Jobber is \_\_\_\_\_  
For convenience, paste coupon on penny postcard.

## ARCTURUS

INDEPENDENT TUBES FOR DEALERS WHO DO THEIR OWN INDEPENDENT THINKING

A TRIPLETT DELUXE MODEL

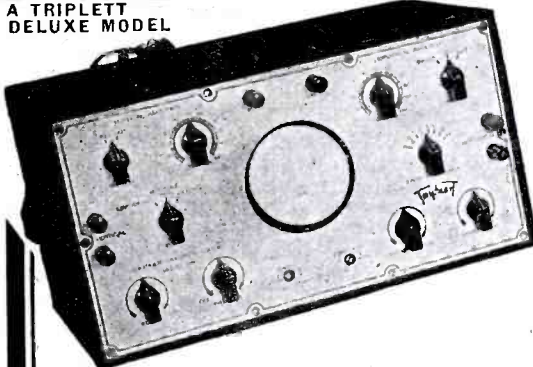

Model 1691, with 3" Cathode Ray Tube. Dealer Price ..... \$62.50

Model 1690—with 2" Cathode Ray Tube. Dealer Price ..... \$47.00  
(in Metal Case)

### ADVANTAGES

This new Triplet Oscilloscope is complete. In addition to radio servicing, it has invaluable applications in radio transmitter, sound equipment, industrial and educational fields.

The cathode ray tube with exclusive Triplet turret type mounting can be moved up or down or to either side for adjustment of the screen to an angle always in direct alignment with the user's line of vision. Adjustable shield can be pulled out to project beyond the screen for easy reading in brightest daylight on Model 1690. (Model 1691 has snap-on shield.)

The Oscilloscope incorporates separately controlled resistance coupled vertical and horizontal amplifiers. Vertical and horizontal plates can be either direct coupled with

Turn Tube in Any Direction For Direct Working View With This

## OSCILLOSCOPE Now Available With 3" Tube

- Exclusive Turret Type Tube Mounting for Adjusting Screen to Any Angle for Direct View
- Extremely Brilliant Pattern
- Linear Sweep 15 to 20,000 Cycles
- 2" and 3" Cathode Ray Tubes

amplitude control, or through amplifiers with amplitude control. Can be used with any type frequency modulated Signal Generator. 60 Cycle A.C. operated.

Linear sweep from 15 to 20,000 cycles. Sweep (either internal, external or 60 cycle) may be used through amplifier or direct with amplitude control. Positive lock. All controls on panel. No interactional controls.

The special instruction book furnished is a treatise on the subject every serviceman should have. It has been prepared by one of the leading experts without spurious costs. Nothing like it has before been furnished.

Model 1690 also is available in black leatherette carrying case with removable cover. Dealer Net Price ..... \$51.00



THE TRIPLET ELECTRICAL INSTRUMENT CO.  
164 Harmon Dr., Bluffton, Ohio

Please send me Catalog on New Triplet DeLuxe Line.

Name \_\_\_\_\_  
Address \_\_\_\_\_  
City \_\_\_\_\_ State \_\_\_\_\_

Please Say That You Saw It in RADIO-CRAFT



## Now . . . A Brand-New RCA AC Oscillator At Lowest Price Ever

Stock No. 153, complete with RCA Metal Tubes

**GIANT DIAL!** Completely AC operated. Wide frequency range - 100 to 30,000 kcs. Harmonics of last band may be used for ultra-high frequency testing. 6 bands. Dial scale length over 50 inches. Calibration accuracy of 2%.

Three attenuator taps plus fine control give continuous control of output from zero to 0.25 volts. Maximum output 1 volt

Internal modulation - 30% at approximately 400 cycles. Jack provided for external amplitude modulation.

External frequency modulation jack provided. 400 cycle output at approximately 8 volts provided for audio circuit testing.

Attractive blue-gray wrinkle finish case with snap handle.

**RCA Parts FOR PROFIT**  
RCA Manufacturing Co., Inc., Camden, N. J.  
A Service of Radio Corporation of America

## Monastery Secrets

### . . . THE FORBIDDEN KNOWLEDGE OF TIBET

What strange secrets of nature are locked within the mountain fastness of Tibet? What control over the forces of the Universe do these cloistered sages exercise? For centuries the world has sought to know the source of their power—to learn their mastery of life, and their faculty for overcoming problems with which the masses of mankind still struggle. Have they selfishly deprived humanity of these rare teachings?

#### WRITE FOR THIS FREE BOOK

Like the streams that trickle from the Himalayan heights to the plateaus below, the great truths of these brotherhoods have descended through the ages. One of the preservers of this wisdom of the sages is the Rosicrucian Brotherhood (not a religious organization). They invite you to write today for their FREE Sealed Book, with its amazing revelations about these mysteries of life. Address: Scribe C.N.Y.

The ROSICRUCIANS  
AMORC  
San Jose, Calif.  
U. S. A.

## TELEVISION STUDENTS LEARN BY MAKING CATHODE-RAY TUBES

(Continued from page 683)

and performance. (While it would be ideal to have adjustable elements in the electron gun, no good solution which can be joined with present vacuum technique has been forthcoming.)

### ELECTRON EMISSION

Our experiments on obtaining the most suitable electron emitter included a simple, pure-nickel filament coated with barium and strontium carbonate mixture. This coating was applied with a spray or by dipping in a solution. The solution consisted of 90 parts *amyl acetate* and 10 parts of *collodion* with enough powder to form a fast-drying "white paint." When the coating was thick and pebbly, like the snow on a refrigerator pipe, the best results were obtained. If the coating was too thin, which we found was recommended by some workers, it would wear away in spots very quickly when in use; on the other hand, if the coating was too thick, it would chip off during formation when first heated up. We were unable to measure the thickness of a good coating and simply resorted to using 3 spray coatings with a uniform mixture, letting the coating dry between each coat. The thickness of the coating affected the life more than the original emission. Very thin coatings emitted as well as the thick ones during the first few hours. (Emission, in this case, means the current between cathode and plate.)

We found no difference in performance between the direct-heater type of coated filament and the indirect type (described in the preceding installment), but the heater-type emitter was far more durable and less subject to burn-out. The emitter end was flat while in the case of the direct-heater filament, the shape was not quite so satisfactory. The heater type also has the advantage of having a smaller alternating current magnetic field to distort the cathode ray or electrons leaving the surface. When electrons move from the surface of the heated filament toward a positively-charged anode and move through a magnetic field, they will follow the 3-fingered "motor rule" for the motion of a conductor passing a current through a magnetic field (only, of course, using the right hand for electron direction instead of the left). If the magnetic field is properly shaped, the electrons will describe a cork-screw type of path and converge at one point called the *focus*, provided the magnetic field encircles the electron beam coaxially as shown in Fig. 4A. Here, the electron assumes a path of least work and any work done by it is returned to the system. That is, the magnetic field simply alters the motion of the electron, and both the magnetic field and the electron work so that no energy is taken away from either the moving electron or the magnetic field in order to bring about the focusing action. The electron spirals around any line of force which it ap-

proaches at an angle when it enters the magnetic field and continues to show this corkscrew motion through it. When it leaves the magnetic field, it travels in a straight path like a ball thrown from a whirling wheel. Obviously, if the magnetic field is not adjusted so as to focus all of the electrons at one point in their corkscrew motion, then, several sections of the corkscrew will be visible on the screen as shown beyond the focus point.

Thus, a magnetic coil may be used to focus the electron stream, but any stray magnetic field not properly shaped will distort the path of the electrons, and if an alternating current through the heater cathode element is permitted to develop a magnetic field it will distort the path of the electrons at the start. A directly-heated filament is more difficult to properly design than the heater type so that the magnetic field does not interfere with the electron path. We were, therefore, very pleased to observe that we obtained as much emission from the heater-type emitter as from the directly-heated type of filament.

### FORMING THE FILAMENT (EMITTER)

The process of "forming the filament," is important. The gas must be totally exhausted from the vessel as well as possible before forming is started. When the emitter is formed, it is brought up to a temperature higher than normal and then a potential difference of 20 volts is applied between the emitter and the nearest anode which is, of course, charged positively to develop a small electron current. This electron current increases steadily starting from zero, and chemical combination between the mixture and the nickel appears to take place. If any gas is present in the tube, or the voltage is raised high enough to ionize the small remaining gas which is usually present until the pumping operation has been entirely completed, then, the positive molecules will bombard the filament surface and tear away large pieces of the emitter materials.

The life of the filament is greatly reduced and affected if this is permitted. The longest life can be obtained by forming the filament at low potentials and with an absence of gas according to our brief and incomplete observations. However, these same cathodes, once well formed, can emit powerful electronic currents in the presence of gas up to 20 millimeters or more in pressure and such emitters are used in our powerful *glow-discharge lamps*. The filament is most badly taxed when the gas is at those extremely low pressures which are low enough to permit cathode rays to be formed and still high enough to form a "glow discharge" where the velocity of the positive molecules is very high. Therefore, small traces of gas in a cathode-ray tube shorten the filament life tremendously.

Please Say That You Saw It in RADIO-CRAFT

Even when the gas is at such a low pressure and the potentials low enough so that no visible glow takes place, the "invisible bombardment" shortens the life of the filament.

This can be demonstrated by comparing the life of identical filaments in tubes that have been exhausted for various numbers of hours ranging from 4 hours up to 4 days on a good pump. The tube that is exhausted for 4 days will have better life and the filament will emit at a lower temperature. We can see from these tests why it pays to pump tubes for a long time.

After we concluded a satisfactory number of filament tests, we put a small hole in the plate immediately in front of the emitter and tested the emission. Such a setup is shown in Fig. 4B. We observed that after the gas was removed the electron current was much lower than one without the plate, and it was evident that the remaining electrons were shooting straight through the hole. By placing a fluorescent screen, on the end of the tube immediately in front of the aperture, we were pleased to observe a uniform glow over the entire surface indicating the arrival of cathode rays.

**FOCUSING THE CATHODE RAY**

We then tried placing a magnetic coil about the neck of the tube and observed that the beam focused to a small spot. The spot, however, had considerable distortion and was far from what could be very acceptable for a "television" cathode-ray tube.

We then tried placing 2 discs in front of the emitter with small holes in the center as shown in Fig. 4C. The disc closest to the emitter was varied from zero to a positive or to a negative potential at will, while the disc on the outside was charged to a high positive potential. The magnetic coil was used to focus the image of the aperture or the filament. When the first disc was charged zero, we were able to see an image of the emitter surface. It looked very much like an astronomical photograph of the sun. It had small pits like volcanoes and as the first disc was slightly varied in potential, huge streamers were seen to project from it according to the screen image. It was evident that we were focusing an electron image with electric means very similarly to the way we focused light images with lenses.

Various literature on the subject has compared electric focusing methods—

using magnetic or electrostatic fields—to optical practice. We, therefore, searched for a design which followed the best procedure used in projection systems, for it was evident that we were dealing with a problem similar to a projector. A good projection system follows the design shown in Fig. 4D. A reflector is placed immediately behind the source of light—a thin collector lens is used immediately in front of it to work as close as possible to the source and then two other condensing lenses are used to converge the light upon the aperture that is to be projected. If this were a motion picture projector or a magic lantern, the film would be placed at the aperture. A corrected lens is then used to project the image at the aperture on the screen. Thus, the function of the condenser lenses is to direct as much light as possible through the aperture. It is self-evident that equivalent electron gun design is desirable.

The RCA Projection Kinescope recently developed has an electric design which follows the best optical procedure in equivalent electric focusing systems. The first aperture appears to act as a reflector and the cathode is placed immediately in front of it. Thus, any electrons emitted are partially pushed through the first hole. The holes in the discs become successively smaller as the electrons are accelerated and finally converge upon the final aperture and cross and again diverge. They are then focused by a combination of the magnetic coil and the aquadag coating to a point on the end of the screen as shown in Fig. 4E.

In Fig. 4F we show a method tried that is entirely electrostatic. This has the advantage of not requiring any outside focusing coil. The performance of this gun was more satisfactory than all other guns tried. It is capable of brilliant performance. At this point, we felt that we had obtained a brilliant and bright enough spot and suitable focusing means for any reasonable television tube. So our next steps had to consist of investigating methods whereby the intensity of the beam could be varied uniformly from darkness to maximum brilliancy without obtaining a variation in the size of the spot that was detrimental in order to conclude our first experiments with electron gun design. The results obtained concerning this work will be published in our next issue.

*This article has been prepared from data supplied by courtesy of American Television Institute.*

**"LEARN-BY-EXPERIMENTING" BEGINNERS' PRACTICAL RADIO COURSE**

ANSWERS TO QUESTIONS ON PAGE 703

1. When testing various resistances with an ohmmeter, the part having a higher resistance will allow: (less current) to flow.
2. A part having an open-circuit, as compared with a good part, will allow: (no current) to flow.
3. A part having a short-circuit, as

- compared with a good part, will allow: (more current) to flow.
4. The moving-coil-type meter, as compared with the vane-type meter, is (more sensitive).
  5. The ohmmeter used here measures (D.C. resistance).

Please Say That You Saw It in RADIO-CRAFT



**"RIDER'S..... Out Front Again"**

Says Service Manager of Leading Set Manufacturer

"That HOW IT WORKS section in RIDER MANUAL Volume VIII, certainly puts Rider out front again! It makes clear the underlying theory you must understand when working on complicated 1938 receivers." In addition to 64 pages on HOW IT WORKS, plus the 128-page INDEX, Volume VIII includes 1650 pages on essential service data on 1715 models of over 100 manufacturers. Yet, the price is the same as last year's Volume—\$10.00!

**RIDER BOOKS BANISH Bewilderment**

Radio Technicians get a sure grasp of the underlying theory of modern sets by using up-to-date Rider Books.

**AUTOMATIC FREQUENCY CONTROL SYSTEMS**

With Automatic Frequency Control Circuits in most new higher-priced models, knowledge of "AFC" means money in your pocket! Learn the practical facts, from these easy-to-understand explanations. Get your copy today. Cosh in on profitable "AFC" work. Hard covers. 144 pp. \$1.00.

**THE CATHODE-RAY TUBE**

Written especially so you can understand the subject. With introduction of new, cheaper Cathode-Ray Tubes, this book is even more indispensable for its complete practical information on Oscillographs, etc. 336 pp. 450 illustrations. \$2.50

**SERVICING SUPERHETERODYNES**

Changes, changes, changes! That has been the history of the superheterodyne circuit. Make repairs quickly by analyzing the different parts of the circuit quickly. Rider shows you how in this revised edition which has 288 profusely illustrated pages. \$1.00

**"AN HOUR A DAY WITH RIDER" BOOKS —60¢ each**

- ON AUTOMATIC VOLUME CONTROL will speed up your AVC work. 96 pp. 65 illus.
- ON RESONANCE & ALIGNMENT. You need this! 96 pp. 48 illus.
- ON D.C. VOLTAGE DISTRIBUTION IN RADIO RECEIVERS. How d-c voltages are led to tube elements, etc. 96 pp. 69 illus.
- ON ALTERNATING CURRENTS IN RADIO RECEIVERS—with drawings and diagrams.

JOHN F. RIDER, PUBLISHER  
1440 Broadway, New York City

**YOU NEED ALL 8 Rider MANUALS**

# TIME PAYMENTS ON EVERYTHING WE SELL

Have all the radio equipment you want when you want it! A few dollars down will bring you the latest and finest equipment. Everything for the "Ham", Service Man and Experimenter. All at rock-bottom prices—ALL sold on convenient Time Payments. Send for your FREE copy of Wards 1938 Radio Catalog NOW.

## MONTGOMERY WARD

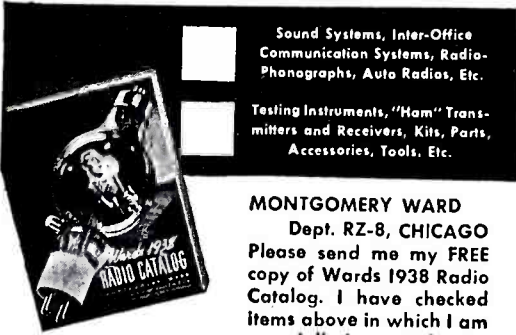

NAME \_\_\_\_\_

ADDRESS \_\_\_\_\_

CITY \_\_\_\_\_

STATE \_\_\_\_\_



## BUILT FOR "DX"

HAMMARLUND components built into your receiver means greater "DX." The "MC" midget condensers together with the "SWK" 17-270 meter "XP-53" low-loss coil set, and the type "S" Isolantite socket are matched parts "built for 'DX'." Send coupon for 1938 catalog.

HAMMARLUND MFG. CO., Inc. RC-4-38  
424-438 W. 33 St., N. Y. City

( ) Please mail me new '38' catalog

Name \_\_\_\_\_

Address \_\_\_\_\_

City \_\_\_\_\_ State \_\_\_\_\_



## HAMMARLUND

## NEW! AUDIO "EXPRESSOR" FOR SOUND SYSTEMS

(Continued from page 676)

If a well-monitored symphonic record is played-back on any high-quality standard, or voice amplifier, it cannot sound real, because the loud "peaks" have been depressed and the low "valleys" have been raised. In fact, all symphonic records are characteristically devoid of their original dynamic volume range, and therefore sound "flat". It is this "flat" effect that robs the finest symphonic recordings of their realism, and enables the layman to tell the difference between a recording and an actual rendition.

### THE VOLUME EXPANDER

Sound engineers have long known the existence of this defect and have labored continuously to rectify this undesirable condition. The problem finally evolved itself around the development of a circuit which would "expand" the dynamic range of symphonic recordings so as to neutralize the effect of compressive monitoring. The volume expansion circuit, as finally perfected, actually undoes the monitoring and enables the recorded version to be played back in exact conformity with the original rendition.

What the expander actually does is to raise the "peaks" (make the loud passages louder). This condition produces the effect of lowering the valleys (making the low passages lower), so that rendition is restored to its original fullness. To listen to a volume expander amplifier for the first time is a revelation. In fact, it is only the absence of the orchestra itself that enables the listener to tell the difference between the real and reproduced version of a recorded selection. (Expansion circuits as an integral part of an amplifier circuit have been described in past issues of *Radio-Craft*. In this article, instead, Mr. Shaney tells how to make up an independent or "add-on" expansion [and compression] unit.—Editor)

### EXPANDER ACTION OF THE EXPRESSOR

A cursory examination of the schematic circuit in Fig. 1 will disclose how the input signal is fed into both the 6S7G remote plate current cut-off tube and the control amplifier section of the 6C8G.

The control section amplifies the input signal and rectifies it in the diode section. The rectifier voltage which appears across its load resistor ( $\frac{1}{2}$ -meg.) is applied through a time-delay circuit to both the control-grid and the suppressor-grid of the 6S7G. A time delay circuit is inserted into the control-grid circuit so as to produce a pleasing rate of expansion. The suppressor-grid, however, acts more rapidly (although not as effectively) to preserve expansion of staccato passages. It will be noted that, during expansion, a positive voltage is developed across the rectifier section. This lowers the effective bias on the 6S7G and raises its mutual conductance.

Figure 2 shows how the mutual conductance of the 6S7G is increased by lowering the control-grid bias and the effective suppressor-grid voltage.

### THE COMPRESSOR ACTION OF THE EXPRESSOR

The reversing switch (S1) reverses the rectifier output voltage and causes the negative voltage to be applied to both the control- and suppressor-grids. This effectively reduces the mutual conductance of the tube and lowers the output voltage when high input signals are present. Its action exactly complements the performance of the expander. In fact, reverse expansion actually takes place. By proper adjustment of the expressor control, a constant output voltage can be maintained over the wide range of input signal levels so that effective automatic audio volume control will take place.

### UNUSUAL APPLICATIONS

The unit has been designed for convenient use with any and all existing type amplifiers. It will be noted (Fig. A) that optional low-impedance input and output transformers are available should it be necessary to match the impedance of any pickup or amplifier input circuit. By inserting the expressor into the microphone circuit—by plugging mike into expressor, and expressor into amplifier—either expansion or compression can be applied to voice or musical pick-up. Ordinarily, the expander should not be applied to speech. The expressor (in the expander position), however, will add some expression to a monotoned orator.

A striking demonstration of the value of automatic audio volume control can be shown by adjusting the maximum output of the system to identical values with and without compression. The use of the compressor will then result in material increase of power output at reduced input signals. In other words, should the orator turn away from the microphone, the sensitivity of the system will automatically increase, so as to maintain, within very narrow limits, a constant output. This extraordinary effect is highly desirable in installations where performers resent the idea of burying their faces in the microphone.

By inserting the expressor into the phono circuit, and plugging the phono pickup into the input jack of the expressor, either expansion or compression can be applied to phono recordings. If the maximum output level of the system be adjusted to identical values with and without expansion, the use of the expander will appear to materially reduce scratch. In fact, it can be shown under actual demonstration that scratch can be completely eliminated from records ordinarily characterized by objectionable scratch. If the low-level passages are adjusted to provide equivalent output with and without expansion, it will be noted that high-level passages will greatly increase the power output

Please Say That You Saw It in RADIO-CRAFT

# NEVER BEFORE

**300 TESTED MONEY MAKERS**  
**MAIL ORDER PLANS**  
**BUSINESS SECRETS**  
**SUCCESS SCHEMES**  
**64 PAGES**

has the small sum of 10c brought you so much as we offer in our 1938 edition 64 page book, 300 TESTED MONEY MAKERS.

In this book you will find all the real money makers which have and still are making money for others,—men who have started on the proverbial shoe-string, and often with less than \$10 capital. In this book you will find dozens of successful mail-order plans, many confidential business secrets, successful formulas and many profitable schemes that are being used by small business traders who are making a good but honest living either in their full time or spare time.

**10c**

WE ONLY ASK YOU TO DEPOSIT THE SMALL SUM OF TEN CENTS WITH US. IF THREE DAYS AFTER RECEIPT OF THE BOOK YOU DO NOT THINK IT WORTH TEN TIMES THE AMOUNT, WE WILL CHEERFULLY REFUND YOUR MONEY.

Do not fail to send for this important book—the New 1938 Edition has just been published. It's sent post-paid. Remember, all of these plans are genuine, NOT JUST IDEAS, but every plan has been tried out successfully. Send coin or U. S. postage stamps.

**NATIONAL PLANS INSTITUTE**

246R Fifth Avenue New York City

## MODEL 801 VOLT-OHMETER

*The Serviceman's Favorite!*



A sensationally low priced instrument that will prove itself to be the busiest meter in your shop. Its accuracy plus its compactness makes it indispensable to the servicemen for general test purposes.

The D'Arsonval type moving coil meter is accurate within 2%. The low resistance scale is calibrated from 0-500 ohms with 50 ohms at the center of the scale, thus permitting accurate resistance readings down to 1 ohm. The high resistance scale is calibrated from 0-500,000 ohms. No external batteries are required for either scale.

DC voltage up to 1000 can be determined. Individual jacks provide for 0-5, 0-50, 0-500 and 0-1000 volt tests.

Net dealers price, complete with battery and prods ..... **\$5.75**

### MODEL 801A AC-DC Volt-Ohm-Milliammeter

Contains the same characteristics as Model 801 Volt-Ohmmeter, with these additional features:

Reading Available:

0-5-50-500 and 1000 volts D.C.; 0-5-50-500 and 1000 volts A.C.; 0-500-500,000 ohms; 5-50-500 and 1000 mills. D.C.  
 Stock No. 801A. Specially priced ..... **\$9.95**

**TRY-MO RADIO CO., Inc.**

85 CORTLANDT STREET NEW YORK, N. Y.

## Correspondence Courses in RADIO and ELECTRICAL ENGINEERING

**ELECTRICAL ENGINEERING** Get good grasp of wide electrical field. Prepare yourself, at Low Cost, for secure future. Modern, simplified, you can understand quickly.  
**RADIO ENGINEERING** Extra fine course in radio, public address, photo-electric work, technician. Exper. kits furnished. Diploma on completion. Tuition, \$25 either course. Deferred payment plan.  
**FREE** Get copies of school catalogs, student magazines, complete details. SEND NOW!

LINCOLN ENGINEERING SCHOOL, Box 831-73. LINCOLN, NEBR.

**\$500,000 GENUINE**

**MAJESTIC-GRIGSBY GRUNOW REFRIGERATOR & RADIO PARTS FOR MODELS PRIOR TO 1936**

**MAJESTIC** UNITS GUARANTEED 18 MONTHS. SEND FOR PRICE LIST. G & G GENUINE MAJESTIC REFRIGERATOR & RADIO PARTS SERVICE 5801 W. DICKENS AVE. CHICAGO, ILL.

## Complete Electric Plants



Onan A. C. plants furnish same current as city lines. 110 Volt, 60 Cycle. For farms, camps, construction jobs. Operate radios, water systems, all appliances. New models, 350 to 5000 watts. 6, 12, 32 and 110 volt D.C. Models \$57.50 and up. Also combination A. C. - D. C. units. Shipped complete, ready to run.

Write for details. D. W. ONAN & SONS 864 Royalston Ave., Minneapolis, Minnesota

over the normal high-level output of the system, and thereby produce a much desired realistic playback performance. It is of course taken for granted that the power amplifier will handle this higher output without introducing undue distortion.

On the other hand, should phono recordings be used for dance purposes in large dance halls where a constant power output is desired, compression may be applied to the phono circuit so as to provide a more uniform output regardless of fluctuations in recording.

### UNUSUAL FEATURES OF THE EXPRESSOR

It will be noted that the unit employs a 6U5 cathode-ray indicator to visually indicate the degree of compression or expansion present. A number of new design principles have been used in producing the power transformer, chokes, and input and output transformers. A dual coil hum-bucking construction is used throughout, so as to avoid undue magnetic or inductive pick-up. A 3-stage filter system is employed to completely eliminate the plate-circuit hum.

Hum usually produced from heater-to-cathode and heater-to-plate emission has been completely eliminated by raising the heater 200 volts above ground so that the heater potential is higher than any other element in the 6S7G, thereby effectively preventing emission to the screen-grid, cathode, and plate circuits. This high "bias" potential does not affect the performance of the other tubes in the unit.

The addition of this expressor to any microphone or phono circuit will not only add considerable flexibility to the reproducing ability of the amplifier system, but will also add approximately 20 db. to any input circuit (when volume control is on full). This will enable the use of low-level microphones with amplifiers designed for high-level inputs. In other words, the unit may also be used as a preamplifier when additional gain is desired.

The entire unit when completed measures 14 ins. long, 6 ins. wide, and 8½ ins. tall. It weighs approximately 12 lbs. and can be readily attached to any existing amplifier. Questions will be gladly answered by the author. Address him care of *Radio-Craft*.

## CANADA'S "INTERFERENCE DETECTIVES"

(Continued from page 703)

it may be corrected by reversing the outside loop leads.

### (D) Probe Reception:

The probe antenna is connected to the terminals PP and reception is obtained by closing the switch (SW.1) on the "probe" side and the switch (SW.2) on "R", leaving the switch (SW.3) on the "loop" side. The probe transformer secondary is now tuned by one-half the gang condenser marked "Tuning".

Once the source of interference has been located, steps must be taken to overcome it. This is done by repairing or replacing defective parts, repairing poor contacts, removing causes of leakage, etc. However the procedure for remedying various sources of noise constitutes the subject matter of subsequent instalments.

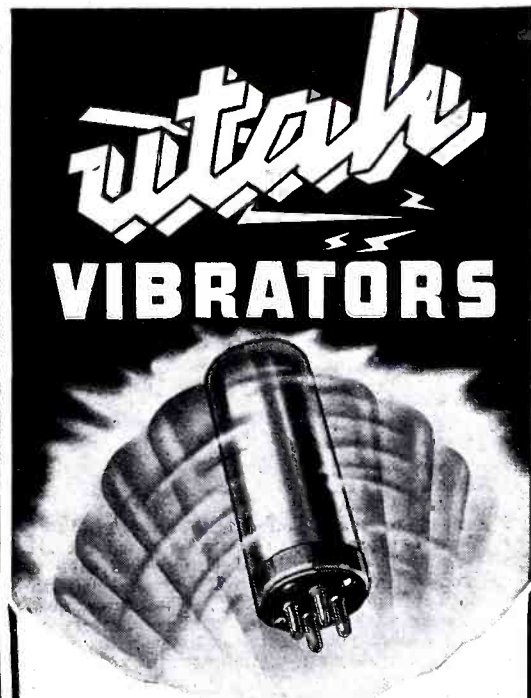

- ✓ **LAST LONGER**
- ✓ **WORK BETTER**
- ✓ **COST NO MORE**

UTAH Vibrators are TOUGH! Impartial tests *prove* it. But UTAH research still goes on. That's why the UTAH factory is responsible for practically every major improvement in vibrator design. And the 1938 UTAH Vibrator is the finest and toughest ever made! Give your customers the vibrator that "can take it." Just say UTAH to your jobber.

- ✓ Corrosion-free contacts because of patented rubber liner.
- ✓ Longer reed life because bending strains are evenly distributed.
- ✓ Shorter leads reduce interference. Held steady with clamps. Breakage is practically impossible.
- ✓ Tungsten contact points. Self-cleaning.
- ✓ Lower rubber liner accurately molded to firmly support mechanism.
- ✓ Rubber liner consists of two parts beveled to make a closer fit and suppress noise.
- ✓ Patented UTAH features make this the finest vibrator ever made.

*Your jobber has UTAH vibrators for all auto and farm radios. Get the best. Always say "Utah!"*

**UTAH RADIO PRODUCTS CO.**  
 CHICAGO, U. S. A.

**BUENOS AIRES-UCOA RADIO PRODUCTS CO.**

**'16 YEARS OF LEADERSHIP'**

**CAN YOU REPAIR ANY MAKE OF RADIO SET?**

**"Yes Ma'm!"**

... is your answer if you get

**FREE**

**EQUIPMENT the**

**EASY NATIONAL UNION WAY**

No need to wish you might have the fine modern equipment you see advertised you can have it. National Union will give it to you with purchases of National Union radio tubes and condensers. It's easier now than ever with both tubes and condensers to apply against your purchase agreement. Find out . . . Ask your distributor. If you don't know who your nearest N.U. distributor is, send coupon or write—right now!

**N. U. TUBES and CONDENSERS are QUALITY PRODUCTS**

Thousands of top notchers in the Radio Service Engineering profession are depending on National Union quality. It's the kind of precision and value that makes good friends for you. National Union quality will never let you down . . . The National Union guarantee is your assurance.

**NATIONAL UNION RADIO CORPORATION**  
570 Lexington Avenue  
New York City RC-438

Who is the nearest N.U. distributor?

Name .....

Address .....

City ..... State .....

Ask your **JOBBER**  
for the **NEW**

**STANCOR**

**"HAMANUAL"**

New Tubes . . . New Circuits

**16 NEW TRANSMITTERS**  
5 WATTS TO 1000 WATTS

**STANDARD TRANSFORMER CORPORATION**  
850 BLACKHAWK STREET, CHICAGO

**Something New!**



**They're Ultra Compact!**

Cornell-Dubilier type BR dry electrolytics (illustrated here actual size) are the last word in efficient compact filter capacitors. Hermetically sealed aluminum case gives absolute protection against heat and humidity. Write for catalog flyer No. 154A, TODAY!

**CORNELL-DUBILIER ELECTRIC CORP.**  
1014 Hamilton Blvd., So. Plainfield, N. J.

**RECENT DEVELOPMENTS IN ELECTRONIC MUSIC**

(Continued from page 667)

and magnetic pick-up units for translating the string vibrations into magnetic field fluctuations, then into electric voltages, and finally into sound, by amplifier and loudspeaker.

A better type of pick-up involves substitution of electrostatic for magnetic pick-up; an adjustable metallic screw is placed near each string. These electrodes are connected together, and shielded from external electrostatic hum fields by a small metal housing. The housing shield is connected to the strings, to the shield of a 1-wire shielded cable and to amplifier ground. The central wire is connected to the pick-up electrodes. Well-filtered polarizing voltage is taken from the amplifier and applied to this wire at the amplifier end through a 10-megohm charging resistance to polarize the pick-up electrodes with respect to the grounded strings of the instrument. Such polarizing voltage is kept off the amplifier grid by a blocking condenser.

The amplifier needs more gain than is necessary for the magnetic pick-up but this presents no difficulty whatever. Properly shielded electrostatically, this pick-up will not respond to any stray electrostatic or electromagnetic hum fields. The magnetic pick-up responds to both types and it is very difficult to shield it from the latter.

The electrostatic pick-up is much more linear in its operation than the magnetic, since the capacity change is a function of the first power of distance; the magnetic type operates more nearly on a square law principle and thus itself causes distortion of the waveform of the string vibration as translated into electrical alternating voltage.

Another advantage of the electrostatic pick-up is that it may be used even with gut strings as on violins, violoncello, double basses, etc. The strings, from a conducting bridge to the pick-up electrodes, need only be slightly conducting for perfect operation. This conductivity may be given them by penciling them with a lead (graphite) pencil, by liquid aquadag, or any other method. With properly arranged pick-ups, such as two electrodes for each string between and out of which the string vibrates, the string need not even be conducting, as it is a dielectric of different dielectric constant than air, and its motion in the electrostatic field between the two electrodes sets up an alternating voltage, just as in the case of the conducting string.

**THE ELECTRONIC PIANO**

The newest instruments to be introduced commercially are *electronic pianos* which use conventional piano cases, strings, keys and hammer actions, pedals, etc. However, they have no sound boards. Opposite the strings for each note is a pick-up screw near the bridge ends. These screws all connect together, carry polarizing voltage, and feed into the first amplifier tube grid through a blocking condenser, just as in the case of the guitar. The strings and plate are grounded to the amplifier chassis. The inside of the piano case is painted with aquadag (colloidal graphite) to shield out external electrostatic hum fields, as before.

Since each note frequency has an adjustment of pick-up output voltage, by its distance adjustment from its strings, it is here possible to tone regulate, or "voice", the sound level output separately for each note of the scale, and thus compensate for any irregularities, at particular frequencies, in the amplifier or speaker frequency characteristic. These pick-ups respond in no way to air-borne sound waves, so they offer no means for acoustic feedback. Indeed, 50-watt power amplifiers and 18-inch, high-efficiency reproducers are being installed right in the piano case. These produce output sound levels as high as 110 db. at 10 feet, or more than 5 times those of the largest concert grand pianos of conventional types using mechanical sound boards for tone production.

Near the string ends the high overtones are strong; near the middle these are weak and the lower ones are strong; at the string middle only the odd-numbered partials are present; at other positions there is no 2nd or 3rd, or 4th or other partials.

Once pick-up position is determined and fixed in the design, there is still plenty of tone quality variation possible by low-pass, high-pass, or band-pass filters. A volume control attached to a swell pedal enables the electronic pianist to do

**Westinghouse Power Generator**

Manufactured for U. S. Signal Corps  
200 Watt. 110 V. AC

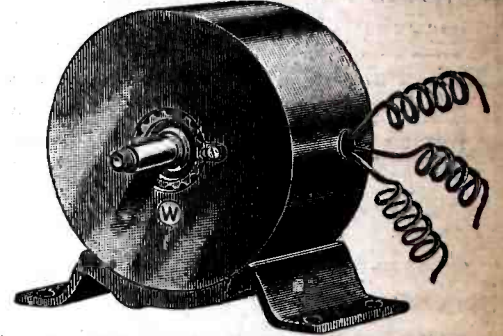

**A. C. ELECTRICAL POWER**

from a Windmill, from available Waterpower, from your Automobile, from your Motorcycle, from your Bicycle, Foot-pedals or Handcrank (for transportable Radio Transmitters, Strong Floodlights, Advertising Signs); do you want to operate AC Radio sets from 32 V. DC farm light systems; operate two generators in series to get 200 V. AC; obtain two phase and three phase AC, etc., etc.

**There Are Over 25 Applications**  
Some of which are:

A.C. Dynamo lighting from eight to ten 20 Watt 110 Volt lamps. Short Wave Transmitter supplying 110 Volts AC for operating "Ham" transmitter. Operating 110 V. AC 60 Cycle Radio Receiver in DC districts. Motor Generator. Public Address Systems. Electric Sirens on motor boats, yachts, etc. Camp Lighting. Short Wave artificial "fever" apparatus. Television. Pelton Waterwheel for lighting or other purposes. Airplane: for lighting strong search lights or electric signs. Laboratory work, etc., etc.

1/4 to 1/2 H.P. needed to run generator.

BLUE-PRINT 22 x 28 in. and Four-Page

8 1/2 x 12 in. INSTRUCTION SHEETS

FREE with Generator.

Generator, as described, including four replacement carbon brushes. Blue-print and instructions . . . . . **\$7.90**

Send \$2.00 deposit balance C.O.D.  
Shipping weight 18 lbs.

(Replacement carbon brushes bought separate \$1.50 per set of four. Set of instructions bought separate \$1.00.)  
**MONEY-BACK GUARANTEE**

**WELLWORTH TRADING COMPANY**

560 West Washington Blvd., Dept. RC-4-38, Chicago, Illinois



**SWAP & SELL**

is the great, big, new magazine that shows you how to get more than 1000 different articles, such as cameras, rifles, books, magazines, clothing, tools, pets, etc., **WITHOUT HAVING TO BUY THEM!**

It runs your own swap ad free!  
It prints letters from men and women who seek new friends!  
It publishes true experiences from real life!  
It tells you how to swap and how to make money!  
It helps you get all the things you've always longed for, yet never could afford!  
You need a copy to help you get more out of life!

**NOT SOLD ON NEWSSTANDS**

**SWAP & SELL**, 99C HUDSON STREET, NEW YORK, N. Y.

**RADIOS..SAVE UP TO 50%**

DEAL DIRECT...FACTORY PRICES! Many models to select from: AC-DC, All-Wave, armchair models; automatic tuning; car radios; Farmsets that operate like city radios! Send postcard for NEW Bargain Catalog FREE. 30-DAY TRIAL plan and agent-user proposition! GOLDENTONE RADIO CO. DEPT. D2, DEARBORN, MICHIGAN.

**\$6.98 UP**

Please Say That You Saw It in RADIO-CRAFT



# WANTED.. YOUR TOUGHEST RESISTOR JOBS!

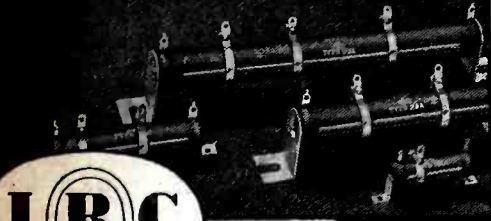

## TRANSMITTING WIRE WOUNDS

They'll stand the overloads. No breakdowns, "opens" or coating cracks. No damage by moisture.

For more than five years, IRC Cement Coated Power Wire Wounds have been proving their superiority. Today you'll find them specified for the most difficult industrial, aircraft, naval and communications applications—jobs where there must be no resistor failures. Write for IRC Catalog No.42.

## INTERNATIONAL RESISTANCE COMPANY

401 N. Broad St., Philadelphia, Pa.

# ELEMENTARY MATHEMATICS

For the Technician and Craftsman

### CONTENTS OF BOOK

I. ARITHMETIC: Addition, Multiplication, Division. II. Factoring and Cancellation, Fractions, Decimals, Percentages, Ratio, and Proportions. III. The Metric System. IV. How to Measure Surfaces and Capacity (Geometry). V. POWERS: Involution—ROOTS: Evolution. VI. Mathematics for the Manual and Technical Craftsman. Thermometer Conversions, Graphs or Curve-Plotting, Logarithms, Use of the Slide-Rule. VII. Special Mathematics for the Radio Technician. VIII. Commercial Calculations, Short-cut Arithmetic, Interest, Discounts. IX. Weights and Measures, Useful Tables.

PRICE  
**50c**  
POSTPAID

## TECHNIFAX

Division RC-438

558 W. Washington Blvd.

Chicago, Illinois

## Breaking all Records FOR PRICE AND PERFORMANCE

MODEL 407  
**AC-DC Multitester \$9.95**

The lowest priced AC-DC tester on the market, yet incorporating all these features: 3/4" bakelite D'Arsonval meter • Multi-colored dial • 4 range AC voltmeter • 3 range ohmmeter • 4 d.b. ranges • 2 current ranges • 4 output ranges • Measures resistance less than .05 ohms.

Write for Catalog C.

## RADIO CITY PRODUCTS CO.

88 PARK PLACE

NEW YORK CITY

what the organist has long done with control of dynamic nuances. These instruments represent the first important improvement in the piano in hundreds of years and extend immeasurably the horizons for pianistic literature and musicians. (See "Latest Tone-Controlled Electronic Piano," Jan. 1937 *Radio-Craft*. Also the book, "A Fugue in Cycles and Bells," by John Mills, [Part III—An Electrical Future for Music]. —Editor)

### MISCELLANEOUS NEW INSTRUMENTS

What of other new developments? In addition to these organs, pianos, guitars, and violins, we have developed numerous other electronic instruments. (See illustrations.)

Among these is a small Swiss music box whose plucked reeds (producing barely audible tones themselves) are provided with an electrostatic pick-up which, with a powerful amplifier produce the tones of a huge bell carillon. This was used, in one town, for audio broadcasting of carols on last Christmas eve.

Another is a bass viol with very big and fine tones; no viol body is necessary and only a long, narrow wood board is used to support the strings, bridge, pick-up and tuning pins.

Another instrument is a battery of 13 kettle-drum-tone producers consisting only of bass viol gut strings about 2 feet long and fitted with electrostatic pick-ups, amplifier and reproducer!

Another of our developments is an electronic harmonica which produces tones as powerful as those of a large organ, and of beautiful quality. We have made this with both electrostatic and magnetic pick-ups for the brass reeds.

We have also developed electronic reed instruments like clarinets and saxophones. In these a tiny, very thin sliver of magnetic iron alloy is cemented to the bamboo reed, near the tip on its inner side. Inside the mouthpiece is mounted a very small, slender, magnetic pick-up well insulated against the moisture of condensed breath, having its pole tip opposite the iron armature on the vibrating reed. Since the reed has reflected into its motion all the harmonics of the instrument's enclosed and vibrating air column, this pick-up develops alternating voltage waveforms just like those of the instrument's output sound waves, and the amplifier produces the sounds of the instrument. However, since these are solo-type instruments playing only one note at a time, various types of distortions may be introduced in the amplifier to alter the output tone quality without in the least developing bad musical effects. In fact a clarinet, by extreme amplifier overloading, may be made to sound as blattant and brassy as a trumpet. It is even possible, by use of a balanced full-wave rectifier, to jump the whole pitch range an octave by the resultant frequency doubling. We have also developed instruments based on beat-frequency-oscillator principles, on photoelectric types of generators, and on electrostatic scanning of conducting waveforms.

### THE "ELECTRONIC ORCHESTRA" OF THE FUTURE

I can visualize the orchestra of the future (and a very near future it is, too, with several already in process of formation) as composed of a great variety of these modern electronic instruments for the creation of music surpassing anything ever before heard in the greatest orchestras of today, not only in power, but chiefly in sheer color, beauty, and intricacy of musical design.

Very likely the conductor will have a much more effective control over his ensemble than he now has with waving baton. His desk will, of course, have the musical score, but it will have much more besides. For every instrument he will have tone quality and power controls so that he can regulate every instrument the better to merge them all into the musical design created in the score and unrolled into a living, moving tapestry of sound through his direction.

What is the purpose of all these developments? There is just one object. This is to provide instruments of unlimited musical versatility; instruments with which all known, and a great many hitherto unknown, musically useful and beautiful sounds may be produced; to give to the performer and to the composer before him new and better tools to enrich his art; to unleash them from the bonds of their traditional implements; to extend the horizons of music which have been almost fixed since the beginnings of recorded history.

# RACO CRASHES THROUGH WITH NEW S-W VALUES

You fans who want real DX must have a RACO SHORT-WAVE RECEIVER. Any one of the many RACO sets pulls in stations from far corners of the globe.

## UNIVERSAL CLIPPER



Uses the new 25L6 low voltage beam power tube which makes possible high power output with an inexpensive A.C.-D.C. power supply, operating from any type of 110-volt current. Here is the famous CLIPPER circuit. The same smooth, non-critical tuning; combined regeneration and super-regeneration; separate bandspread and ultra-high frequency tuning condenser; 5 inch dynamic speaker; 3 to 555 meter tuning range; automatic earphone jack; in fact, all of the splendid features which make the CLIPPER circuit a tremendous success.

ASK THE MAN WHO OWNS A CLIPPER—LOOK AT HIS LOG!

COMPLETE KIT WITH ALL PARTS ASSEMBLED and wiring diagram; less only tubes and cabinet, unwired ..... **\$12.40**

Black crackle finish cabinet ..... 1.80  
Matched set of five tubes ..... 3.20  
Wiring ..... 2.90

UNIVERSAL CLIPPER—COMPLETE, with black crackle cabinet (20" x 10" x 9"); five tubes; 6K7, 2-6J5G, 25L6, 25Z6G; ready to operate, and one-year guarantee. Special Complete Price ..... **\$19.50**

## THE NEW RANGER

3-TUBE UNIVERSAL A.C.-D.C.

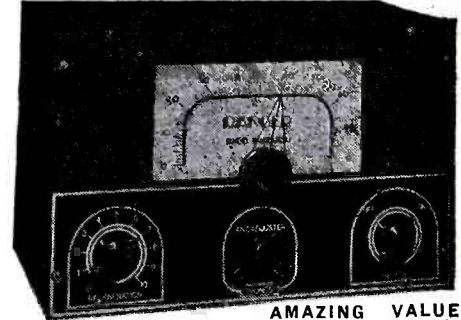

### AMAZING VALUE IN THIS SPLEN-

DID ALL-WAVE SET! You will be astounded at the way it brings foreigners rolling in. Yes, and separates them, too! Uses supersensitive electron coupled regenerative circuit giving smooth tuning and perfect regeneration control over its entire wave-length range. Tunes from 15 to 550 meters with positively no skips.

RANGER 3-TUBE UNIVERSAL A.C.-D.C.—complete kit, assembled but not wired, including wiring diagram and broadcast coil but less cabinet and tubes ..... **\$4.50**

3 additional coils (15 to 200 meters) ..... .60  
Crystallized metal cabinet ..... .90  
Set of three tubes (2-6J5G; 1-6A7) ..... 1.35  
Wired and tested ..... 1.40

SPECIAL COMPLETE PRICE with all coils, cabinet and tubes, wired and tested, with one-year guarantee ..... **8.25**

## FREE Catalog!

Kits, receivers, converters, valuable antenna information—everything you'd expect to find in a complete short-wave catalog—at prices astoundingly low. Write today for RACO'S LATEST SHORT-WAVE CATALOG—illustrating and technically describing RACO'S complete line of long distance receivers.

ADDRESS DEPT. RC-438



## RADIO CONSTRUCTORS LABORATORIES

136 LIBERTY ST., NEW YORK, N.Y.

• WITH RACO SHORT-WAVE KITS YOU CAN ALWAYS BUILD BETTER RECEIVERS •

# BUILD A QUALITY RECEIVER

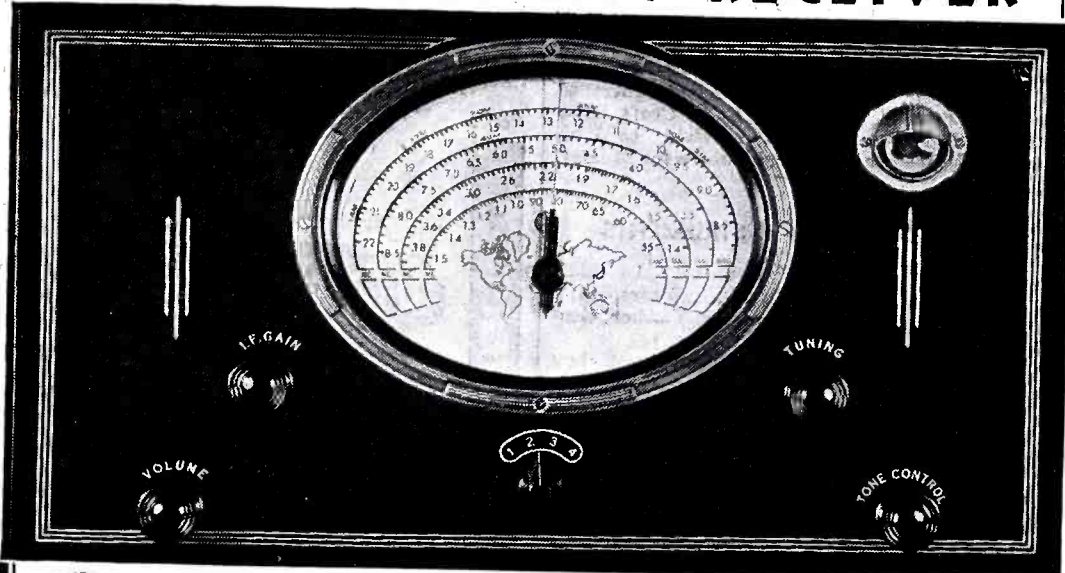

**THE BROWNING LABORATORIES, INC., ANNOUNCES  
THE BROWNING 83-THE TEN TUBE, FOUR BAND KIT RECEIVER  
HIGH SIGNAL-TO-NOISE RATIO FOR DX RECEPTION - ADAPTABLE TO  
EXPERIMENTATION - INSTALLATION IN YOUR PRESENT FINE CONSOLE**

ASSEMBLE THE BROWNING 83. Browning Model No. 1 Tuner completely wired, aligned and tracked at the Laboratory. Complete final alignment of receiver may be made without a signal generator.

A WORTHY SUCCESSOR TO THE BROWNING-DRAKE AND THE BROWNING 35  
WRITE FOR DETAILED INFORMATION AND CIRCUIT DIAGRAM

**BROWNING LABORATORIES, INC., — 750 MAIN ST., WINCHESTER, MASS.**

## OPERATING NOTES

(Continued from page 682)

circuited or leaky 6B7 cathode bypass condenser. This is a 4 mf. electrolytic unit mounted on the terminal strip under the power transformer. In some cases, reproduction will not be choked but only badly distorted, the degree of distortion depending upon the leakage in the electrolytic bypass condenser, which reduces the cathode voltage. Measurements made with a good ohmmeter connected between the cathode of the 6B7 socket and chassis with the positive terminal of the ohmmeter connected to the cathode, should produce a reading of approximately 5,000 ohms.

Inoperation of these models is often due to an open-circuited or burned-out 30,000-ohm oscillator plate series resistor, a carbon unit. Where the paint on the resistor is blistered or burned, check immediately the 4 mf. electrolytic condenser bypassing this resistor, for a short-circuited condition. This condenser is one section of a dual block mounted to the left of the wave-band switch upon the front of chassis.

(Continued on page 717)



## Quiet Your Razor to Quiet Your Radio!

Filternoys Suppressor F01DH is an approved plug-in device to be attached to any electric razor and plugged into the electric fixture. It takes the noise of an electric razor's motor out of your radio programs.

CONTINENTAL Filternoys F01DH, list price \$1.00, offers radio servicemen a handy profitable item to sell on many service calls. Carry a few in your kit. Any CONTINENTAL CARBON distributor can supply you.

### CONTINENTAL CARBON Inc.

13914 LORAIN AVE., Cleveland, Ohio  
Also, Toronto, Canada

Makers of Carbon Resistors, Paper Condensers, and Noise Suppression Filters

Enclosed find 10c in coin or stamps for my copy of Handy Pocket Data on Radio Interference Elimination.

Name ..... Address .....  
City ..... State .....

### SERVICEMEN AND SET BUILDERS

DON'T BUY RADIO PARTS OR SETS UNTIL YOU RECEIVE OUR WHOLESAL CONFIDENTIAL CATALOGUE. SENT FREE UPON REQUEST.

**UNITED RADIO COMPANY**

58-M MARKET STREET

NEWARK, N. Y.

## RADIO INTERFERENCE NOW INTERNATIONAL PROBLEM

Radio-Craft magazine takes pleasure in endorsing a truly worthwhile activity inaugurated by Frank L. Carter, of East Rockaway, Long Island, N. Y.

Writing in the February, 1937, issue of this magazine, Mr. Carter detailed some of the causes of man-made static. Even at that time he had organized his National Association for Prevention of Radio Interference (N.A.P.R.I.) and had aroused national interest therein.

When publishing his article, Radio-Craft called attention to the N.A.P.R.I., and suggested that listeners might address it in care of the magazine. Now the editors go a step farther. They reproduce herewith the N.A.P.R.I.'s statement of its purposes and principles, together with a coupon for the use of readers who may wish to share in the good work being done.

The statement, which the N.A.P.R.I. is anxious to have reprinted and distributed in as many localities as possible, in order to secure the large membership which is necessary if action is to be secured, reads as follows:—

The purpose of this association is solely to work for improvement of radio reception throughout the entire spectrum, through elimination by law and in other ways, unreasonable, preventable, and unnecessary electrical disturbances which are knowingly and wilfully created and which

distort radio signals to the detriment not only of listeners' enjoyment of their radio receivers, but also constitute serious menaces to efficient operation of military, police, aviation and general commercial point-to-point radio communication.

Achievement of this purpose will be brought about chiefly through cooperation of manufacturers and users of electrical apparatus which causes radio interference. This cooperation eventually will result in improvement of such devices so that they no longer will radiate interference.

Inasmuch as it has only been very recently that radio interference has come to be recognized both as a public nuisance and a menace to public safety, very few communities as yet have suitable legislation providing for control of interference-causing apparatus. One of the primary purposes of this association is to devise and bring about the passage and enforcement of such legislation.

Radio interference is an international as well as a local problem, and should be governed both by local and international law.

Associate membership in this association entails no responsibility upon the member for the actions of the association or its financial obligations; there are no dues or other expenses developing upon the member. In becoming an associate member your only obligation is your pledge to support suitable local and international legislation for control of interference and where possible to use only such electrical equipment as has been so designed and constructed that it will not cause interference.

FRANK L. CARTER,  
President.

The membership application, printed below, may be sent directly to "N.A.P.R.I."

National Association for Prevention of Radio Interference,  
East Rockaway, Long Island, N. Y.

Dear Sirs:

Please enroll me as an associate member of the N.A.P.R.I. I agree to do all in my power to further the purpose of the association in securing passage of adequate legislation for control of preventable radio interference. I also agree that wherever possible I will avoid the use of any electrical apparatus which causes such interference.

Name .....  
Address .....  
City & State .....

Please Say That You Saw It in RADIO-CRAFT

**3 NEW 64-PAGE BOOKS!**  
added to the famous

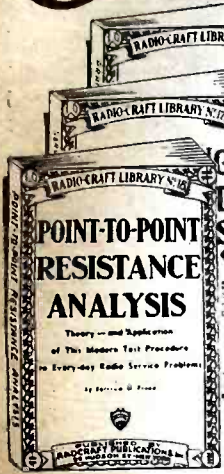

**RADIO-CRAFT LIBRARY SERIES**

**PRACTICAL RADIO CIRCUITS**

**SERVICING WITH SET ANALYZERS**

**POINT-TO-POINT RESISTANCE ANALYSIS**

HERE are three NEW TITLES just added to the popular RADIO-CRAFT LIBRARY SERIES. Radio men will want to read these new books . . . and refer to them often for reference. Each volume contains

64 pages, bound between stiff, flexible covers, and measures 6 x 9 inches to conform with others in the series. Dozens of illustrations appear in each volume. A resume of the contents of each book appears below.

No. 16

**PRACTICAL RADIO CIRCUITS**  
By David Bellare

INTRODUCTION \* BROADCAST RECEIVERS—Crystal Receivers; Regenerative Circuits; T.R.F. Circuits; etc. \* ALL-WAVE RECEIVERS—Superhet with Phase Inverter and Colorama Tuning; Circuit with AFC System; etc. \* SHORT-WAVE SETS, CONVERTERS AND ADAPTERS \* AUTOMOBILE RECEIVERS—Superhets with AVC; Custom-built; Battery-operated; etc. \* PUBLIC ADDRESS—A Variety of P.A. Systems Are Described; Auto-howl; Magic-Eye; Volume Expansion; etc. \* POWER PACKS \* TELEVISION RECEIVERS \* SIMPLE LOW-POWERED TRANSMITTERS \* TEST EQUIPMENT \* MISCELLANEOUS APPARATUS for many needs.

OVER 100 ILLUSTRATIONS

No. 17

**SERVICING WITH SET ANALYZERS**  
By H. G. McEntee

INTRODUCTION \* FUNDAMENTAL ANALYZER PRINCIPLES—Various Types and Uses of Switches; Elementary Set Analyzer Circuits \* TROUBLE SHOOTING WITH SET ANALYZER—Preliminary Checking; Testing Tubes under Operating Conditions; Point-to-Point Testing; Checking Individual Components \* ASSOCIATE TESTING EQUIPMENT—Vacuum Tube Volt-meter; Test Oscillator; Output Meter; Oscilloscope \* COMMERCIAL TESTING EQUIPMENT \* RMA SOCKET NUMBERING SYSTEM.

OVER 80 ILLUSTRATIONS

No. 18

**POINT-TO-POINT RESISTANCE ANALYSIS**  
By Bertram M. Freed

Value of Resistance Method of Servicing \* Basic Principles Involved in Point-to-Point Analysis \* Methods and Instruments Employed in Resistance Measurements \* Point-to-Point Testing Equipment \* Easily Constructed Multi-Range Volt-Ohmmeter \* Resistance in Radio Receivers \* Typical Point-to-Point Analysis of a Modern Receiver \* Combination Voltage and Resistance Point-to-Point Analysis \* Actual Service Problems \* Appendix. OVER 65 ILLUSTRATIONS

**RADCRAFT PUBLICATIONS, Inc.**  
99 Hudson Street, New York, N. Y.

To Order Any of These Books—  
**CLIP AND MAIL COUPON BELOW!**

**RADCRAFT PUBLICATIONS, Inc.** RC-438  
99 Hudson St., New York, N. Y.

Gentlemen: Enclosed you will find my remittance of \$..... for which please send me, POSTPAID, the books checked below, at Fifty Cents (50c) per copy.

- No. 16—PRACTICAL RADIO CIRCUITS
- No. 17—SERVICING WITH SET ANALYZERS
- No. 18—POINT-TO-POINT RESISTANCE ANALYSIS

Name .....

Address .....

City ..... State .....

(Remit by check or money; register letter if you send cash or unused U. S. Postage Stamps.)

**CIRCUIT FEATURES OF 1937 AND '38 INSTRUMENTS**

(Continued from page 669)

while the tube is hot will light up and give a visual indication on leakage resistance up to 500,000 ohms. The circuit arrangement employed is shown in Fig. 1B. The flexible connectors are removed from the neutral jacks and placed into the plate bus, one at a time. A permanent glow in the neon tube when this is done with any of the connectors indicates leakage (or a short) in the tube. This set-up is satisfactory for testing inter-element leakages, for a tube having an inter-element leakage under 500,000 ohms will not ordinarily operate satisfactorily.

If the same set-up were used for testing hot-cathode leakage it would reject almost all "good" tubes, because all satisfactory tubes have a permissible hot-cathode leakage of this extent. In many tube testers this problem is attacked by reducing the sensitivity of the neon lamp so that good tubes will not be rejected on the hot-cathode leakage test. The resultant disadvantage is, of course, that the less sensitive test set-up will pass as OK some faulty tubes which have a higher inter-element leakage than is permissible but which is yet not quite low enough to show up on the reduced-sensitivity neon-lamp type set-up.

In the "306" tester no compromise is made. Two separate test arrangements are employed. The high-sensitivity neon tube arrangement just described is used for all inter-element leakage tests, and the meter test arrangement shown in Fig. 1C is employed for the hot-cathode leakage test. With the plate connector placed in one of the plate bus jacks and the cathode connector in one of the cathode bus jacks, the cathode bus is normally disconnected from the transformer. Then, if the tube has cathode leakage, the leakage between cathode and heater will provide the return circuit for the plate current of the tube to flow back to the transformer, and the meter pointer will show a deflection. Its magnitude depends upon the amount of cathode-heater leakage.

**(5) TEMPERATURE COMPENSATION CIRCUIT FOR RECTIFIER-TYPE METERS**

Clough-Brengle Model 120 Rectifier Circuit. It is generally well known that, unless special compensating features are built into rectifier-type A.C. meters, changes in temperature may cause relatively large errors in their indications. As the temperature increases, the meter becomes more sensitive and therefore gives higher readings, while the input resistance to the rectifier decreases with a temperature increase. The result of these various changes is to give higher meter readings with a rise in temperature.

To compensate for these "temperature" characteristics the "120" rectifier meter circuit is arranged as shown in Fig. 2C. It consists of a D.C. meter, (Continued on following page)

Please Say That You Saw It in RADIO-CRAFT

**"I'M THE BOY WHO'S SATISFIED!"**

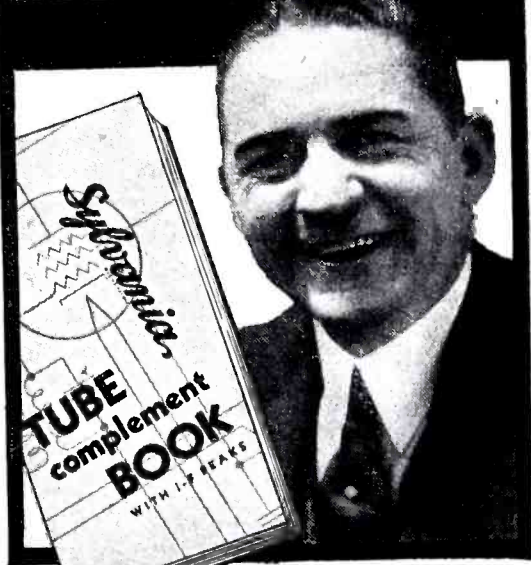

**"I paid 25c. for a tube complement book that has already repaid its cost many times!"**

The Sylvania Tube Complement Book can save you money, too. For this manual tells before you leave to service a set, just what tubes you need to take. That means no return trips to the shop . . . no wasted gasoline . . . no loss of time.

Servicemen like this tube complement book. It gives the tube complements of 10,386 radio models . . . contains the most complete compilation of if-peak available . . . names and addresses of all active radio receiver manufacturers . . . helpful articles dealing with tube selling, etc.

And there are lots of other features too—all designed to be of help to servicemen. Send 25c and the coupon below for your copy of the Sylvania Tube Complement Book. Or get it from your local jobber.

Hygrade Sylvania Corporation also manufactures the famous Hygrade Lamp Bulbs

**SYLVANIA**

Set-Tested Radio Tubes

HYGRADE SYLVANIA CORPORATION  
Emporium, Pa. RC-48

Enclosed please find 25c. Send me my copy of your new Tube Complement Book right away.

Name .....

Address .....

City ..... State .....

- Dealer  Service Man
- Amateur  Experimenter



# PYRO PANTAGRAPH

Size of Box: 12 1/2 x 8 1/2 inches



**\$2.75**

Shipping Wt. 3 lbs

**THIS** electrical outfit is especially designed for burning designs permanently on materials such as Leather, Wood, Cork, Bakelite, etc. Plug the Pyro-electric pencil in any 110 volt AC or DC outlet and it is ready to be used. Plug and cord furnished.

By the use of the Pantagraph included in the outfit, any design may be reproduced either in original, reduced or enlarged form.

Outfit consists of: one Pyro-electric Pencil; one Pantagraph; three hardwood plaques; one bottle of Varnish; one Brush; one tracing tip and four-page instruction sheet.

Size of box: 12 1/2 x 8 1/2 inches.

Outfit will be forwarded by Express Collect if not sufficient postage included with your order.

## WELLWORTH TRADING CO.

558 W. Washington Blvd., Dept. RC-4, Chicago, Ill.

# FACTORY TO YOU

NEW REMINGTON NOISELESS PORTABLE!



**10¢ A DAY**

Famous Remington Noiseless Portable that speaks in a whisper, only 10c a day, direct from factory. Standard keyboard. Automatic ribbon reverse. Variable line spacer and all the conveniences of the finest portable ever built. PLUS the NOISELESS feature. Act now. Send coupon TODAY for details.

**You don't RISK a Penny**  
We send you Remington Noiseless Portable for 10 days' free trial. If not satisfied, send it back. We pay all shipping charges.

**FREE Typing Course and Carrying Case**  
You will receive FREE a complete simplified home course in Touch Typing. Also FREE, a handsome, sturdy carrying case. No obligation. Mail coupon for full details—NOW

Remington Rand Inc., Dept. 189-4  
465 Washington St., Buffalo, N. Y.  
Tell me, without obligation, how to get a new Remington Noiseless Portable, plus Free Typing Course and Carrying Case, for 10c a day. Send Catalogue.

Name .....  
Address .....  
City ..... State .....

### Better - Quicker - More Profitable Servicing with RADIO CHASSIS CRADLE

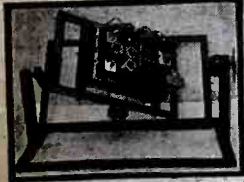

Service shops need the RADIO GIMBLE (chassis cradle) for efficient servicing of testing and repairing of receivers or amplifiers. Equipment clamps to cradle which can be adjusted to any angle. Accommodates chassis up to 13 x 12 x 23 inches. Excellent for displaying receivers. Write for illustrated circular RC1

WM. A. THOMAS CO. 321 CAROLINE ST., NEENAH, WISCONSIN

# RADIO ENGINEERING,

broadcasting, aviation and police radio, servicing, marine radio telegraphy and telephony, Morse telegraphy and railway accounting taught thoroughly. Engineering course of nine months' duration equivalent to three years of college work. All expenses low. Catalog free. School established 1874.  
Dodge's Institute, Hudson St., Valparaiso, Ind.

connected across jacks 4 and 5. Switch H is now set at the proper range-tap. This simply puts the unknown resistor in series with the meter.

To use the instrument for the low 0-2,000 ohm range, jacks 4 and 5 are first "shorted" and resistor G is adjusted for full-scale deflection. Now the unknown resistor is connected across jacks 1-2. This shunts the meter and reduces the deflection, indicating the exact reading in ohms on the instrument scale. This is the familiar "back-up" type of ohmmeter circuit.

### (7) TEST OSCILLATOR WITH PLUG-IN COILS

Readrite-Ranger Model 557 Test Oscillator. Departing radically from what has become almost standard practice in test oscillator design, this 2-tube battery-operated oscillator uses special plug-in coils to achieve high accuracy and wide frequency range in a low-cost unit. By employing 5 plug-in coils, a range of from 110 to 20,000 kc. is obtained. The unit is direct-reading on all wave-bands.

The circuit diagram of the oscillator is shown in Fig. 1D. A cut-away view showing the interior of the plug-in coils is shown in the inset in Fig. 1D. It will be seen that for 4 of the coils, the grid winding is tuned by two 265 mmf. variable tuning condensers connected in parallel, in addition to a small trimmer condenser which is located inside the coil and which is adjusted at the factory. On the short-wave band, one of these 265 mmf. tuning condensers is automatically cut out of the circuit.

Each coil is individually calibrated at the factory by peaking with the trimmer condenser—the trimmer condenser being built as an integral part of the coil.

## OPERATING NOTES

(Continued from page 714)

Strong oscillation with weak, choked signals sometimes accompanied by motor-boating has been traced to an open-circuited oscillator plate bypass condenser, the 4 mf. unit mentioned above. It is meant by "an open-circuited condition" that the condenser has lost capacity as a result of excessive temperature, overload or other causes.

Fading and intermittent reception, wherein the volume level drops appreciably, and signals may be received with a fair degree of station or resonance hiss, in some cases has been found to be caused by open-circuiting or open-circuited 0.05-mf. 1st-detector—oscillator and I.F. grid filter condensers. The failure may be attributed to poor internal contact of the pigtail leads to the foil.

The complaint frequently encountered with these models is that of a slipping dial. The drive arrangement operates satisfactorily when the tuning knob is pulled out for vernier or slow-speed tuning, but will slip badly when the tuning knob is pushed in for fast tuning. This condition is caused by the

(Continued on following page)

Please Say That You Saw It in RADIO-CRAFT

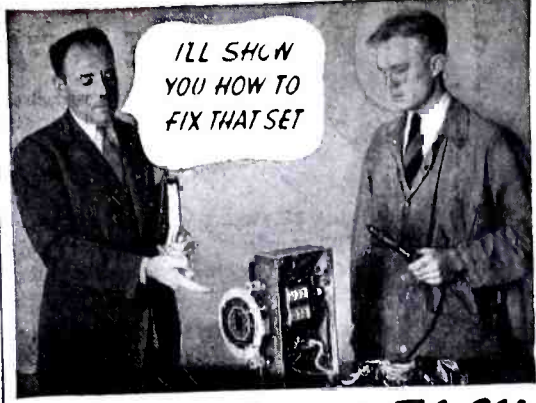

## All Service Jobs made EASY - if you use "Ghirardi"

HERE'S WHAT HE'LL DO FOR YOU!

**TEST INSTRUMENTS**  
He'll explain everything about the construction and operation of all types of servicing instruments, with diagrams, construction data, etc.—even how to build your own!

**TROUBLE-SHOOTING**  
He'll give you latest repair methods for parts and sets, how to align superhets eliminate electrical interference, etc.

**REPAIR METHODS**  
He'll show you latest repair methods for parts and sets, how to align superhets eliminate electrical interference, etc.

**SPECIALIZED SERVICING**  
He'll throw in a whole course on Auto-Radio installation and servicing from A to Z, servicing All-Wave sets, High-Fidelity sets, etc.

**CASE HISTORIES, Etc.**  
He'll give you the "Case Histories" of over 1500 receivers, I. F.'s of over 6,000 superhets, and over 25 invaluable tables and charts to speed up your service work—and keep more coming to you regularly in his "Supplement Sheet Service."

Let A. A. Ghirardi come into your shop and help you with your radio service work! Just like having constantly at your elbow one of the greatest radio servicing authorities in the world—when you get Ghirardi's 2 great servicing books and start using them in your work. They're so practical and to the point—so well illustrated, clear and easy to understand—that they'll make every repair job easier, quicker, more profitable to handle.

### The whole science of Radio servicing clearly explained

In his MODERN RADIO SERVICING book, Ghirardi gives you the most complete accumulated knowledge available on present-day servicing methods and practices—test instruments, trouble-shooting, repairing, etc. It explains exactly WHAT TO DO and HOW.

### Handy DATA BOOK, too!

The loose-leaf RADIO FIELD SERVICE DATA book is full of just the kind of receiver data you're always needing in a hurry on every service job—in the shop and out. A regular Supplement Sheet Service keeps it always up to date. Time saved means more money, so save your money by ordering today these 2 "extra hands" for your shop. Mail the coupon right now! You don't risk a single penny!

**MODERN RADIO SERVICING & RADIO FIELD SERVICE DATA BOOK**  
1800 PAGES 813 ILLUS. (TOTAL)  
Both Books for \$6  
Sent Postpaid Anywhere!



**SPEED UP**  
Your Service Work with GHIRARDI'S GADGETS  
In a flash these amazing Pocket Trouble Shooters spot over 800 different set troubles over you exact TESTS and REMEDIES. One each for HOME and AUTO radios—no day Trial. Free Circular—no obligation! Write RADIO & TECHNICAL PUBL. CO., 45 Astor Pl., Dept. RC-48.

**FREE TO SERVICEMEN RADIO PROFITS**  
ZENITH PHILCO CROSLLEY RCA Victor Grunow Emerson  
BUY WHOLESALE—SELL RETAIL  
Send for sales data TODAY! Sell 1938 nationally advertised radios for big profits. ACT AT ONCE! WRITE  
RADIO DISTRIBUTING COMPANY  
1080 NORTH HALSTED STREET CHICAGO, ILLINOIS  
COMPLETE DISCOUNT SALES PLAN SENT



# BRINGS YOU ANY ONE OF THESE 4 FAMOUS RADIO BOOKS

RADIO FANS! Help yourselves to a radio education for the price of 10c per book. These books give you a good foundation towards the study of radio. You'll be amazed at the wealth of information contained in them. They are especially written for beginners but are useful review and reference books for all.

Each book contains 32 pages, profusely illustrated with clear, self-explanatory diagrams. They contain over 15,000 words of clear legible type. They are an education in themselves and lay the groundwork for a complete study of radio and electricity.

### HOW TO BUILD FOUR DOERLE SHORT-WAVE SETS

Due to a special arrangement with the publishers of SHORT WAVE CRAFT, we present in this book complete details for building the Doerle sets, also an excellent power pack if you plan to electrify any of the sets. Contains EVERYTHING that has ever been printed on these famous receivers. These are the famous sets that appeared in SHORT WAVE CRAFT: "A 2-Tube Receiver that Reaches the 12,500 Mile Mark," by Walter C. Doerle, "A 3-Tube 'Signal Gripper,'" by Walter C. Doerle, "The Doerle

### HOW TO MAKE THE MOST POPULAR ALL-WAVE 1- AND 2-TUBE RECEIVERS

This book contains a number of excellent 1- and 2-tube sets, some of which have appeared in past issues of RADIO-CRAFT. These sets are not toys, but have been carefully engineered. They are not experiments. To mention only a few of the sets the following will give you an idea. The Megadyne 1-Tube Pentode Loudspeaker Set, by Hugo Gernsback—Electrifying The Megadyne—How to Make a 1-Tube Loudspeaker set, by W. P. Chesney—How to Make a Simple 1-Tube All-Wave Electric Set, by F. W. Harris—How to Build a Four-in-Two All-Wave Electric Set, by J. G. Bernsley, and others.

Each set is fully described in simple language so that anyone can build with limited means and with practically no experience a worth-while all-wave radio set. Has 30 illustrations. 10c postpaid

### ALTERNATING CURRENT FOR BEGINNERS

This book gives the beginner a foothold in electricity and radio. Electric circuits are explained in simple language. This includes Ohm's Law, alternating current, sine waves, volts, amperes, watts, condensers, transformers, motors and generators, A.C. instruments, house-wiring systems, electrical appliances and electric lamps. Here are some of the practical experiments which you can perform. Simple tests for differentiating between A.C. and D.C.; how to light a lamp by induction; making a simple electric horn; demagnetizing a watch; testing motor armatures; charging storage batteries from A.C. outlet; testing condenser with A.C.; making A.C. electromagnets; frying eggs on a cake of ice; making simple A.C. motors and many others. Has 42 illustrations. 10c postpaid

### ALL ABOUT AERIALS

In simple, understandable language this book explains the theory underlying the various types of aerials; the inverted "L," the Doublet, the Doublet, the Doublet, etc. It explains how noise-free reception can be obtained, how low-impedance transmission lines work; why transposed lead-ins are used. It gives in detail the construction of aerials suitable for long-wave broadcast receivers, for

## RADIO WAVES USED TO COMPLETELY CONTROL REMOTE RECEIVER

(Continued from page 679)

a separate tuning circuit, and every circuit tuned to another frequency, a great number of tricks may be performed.

It may be of interest to notice that only 1 type 313A tube is employed in the modern system (which has been developed by RCA License Laboratory); and 2 other tubes\* (see note) of standard and cheaper design. Instead of 10 frequencies (Fig. 1B) only 2 are used in actuality, namely 200 and 300 kc., but despite the fact that the number of tubes and frequencies has been reduced considerably one can hardly say that the function of the radio remote tuning system has become simpler.

The contrary is the case because we now must send so-called "A"- and "B"-phased, modulated-radio impulses over the powerline to the remote radio receiver. Radio Service Men of the future in all probability will have to acquire an engineering degree from an institute of technology in order to understand how to service such a set.

A simplified outline as to how the new system operates is shown in Fig. 1D. A small box containing 2 small oscillator tubes and 10 pushbuttons is plugged into the nearest wall outlet of the house powerline. One of the buttons is pressed and an impulse of either 200 or 300 kc. and with A- or B-phased modulation is sent to the remote radio receiver. If one does not care for the station thus tuned-in, another button is pressed. This causes the set to tune to the preferred station. And finally, if the loudspeaker volume is too low or too high, a 3rd button accomplishes the necessary alterations. (See Note, below.—Editor)

NOTE:—This story of RCA Lab's remote control system has been divided into two major classifications, (1) the gas-switch tube circuit for turning the remote radio set off or on; and, (2) the highly ingenious selection system for tuning and volume control. Due to the complexity of the complete system only the off-on operation has been described in any considerable detail inasmuch as this, from the consumer's standpoint, in the long run will perhaps be found to be the most important element. Due to this brevity in the treatment of the story we add the following few words which may serve to clarify several points in connection with the second portion of this remote control system. \*The 2 tubes mentioned are a 6N7 and a 6R7. They are located in the main radio receiver. The R.F. signals from the remote control box are fed into tuned

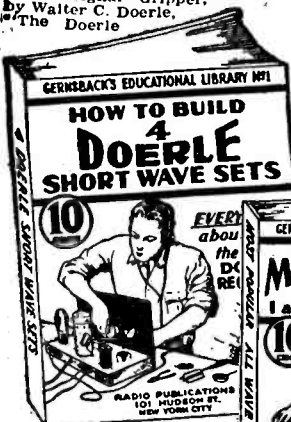

'2-Tube' Adapted to A. C. Operation. 'The Doerle 3-Tube 'Signal Gripper' Electrified, and 'The Doerle Goes 'Band Spread.' Has 30 illustrations. 10c postpaid

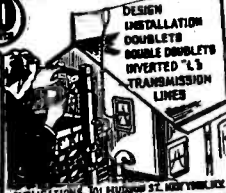
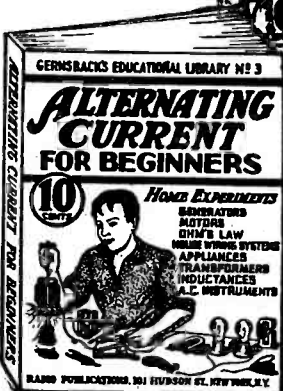
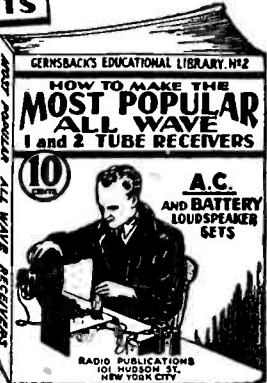

Short-wave receivers, and for all-wave receivers. The book is written in simple style. Various types of aerials for the amateur-transmitting station are explained, so you can understand them. Has 66 illustrations. 10c postpaid

Remember that each book has 32 pages and contains over 15,000 words. Each book has from 30 to 66 fine illustrations. POSITIVELY THE GREATEST 10c VALUE IN RADIO BOOKS EVER OFFERED TO THE PUBLIC.

If you do not think that these books are worth the money asked for them, return them within 24 hours and your money will be instantly refunded.

Send for our FREE circular listing 48 new 10c Publications

**RADIO PUBLICATIONS**  
99A Hudson St., New York, N. Y.

RADIO PUBLICATIONS 99A Hudson Street, New York, N. Y. RC-4-38

Please send immediately POSTPAID the books checked:

- No. 1—How to Build 4 Doerle Short Wave Sets.....10c
- No. 2—How to Make the Most Popular All-Wave 1- and 2-Tube Receivers.....10c
- No. 3—Alternating Current for Beginners.....10c
- No. 4—All About Aerials.....10c

I am enclosing.....c; the price of each book is 10c

Send me FREE circular listing 48 new 10c publications

Name .....

Address .....

City ..... State .....

(U. S. Coin or U. S. Stamps acceptable.) Books are sent postpaid.

**CLASSIFIED ADVERTISEMENTS**

Advertisements in this section are inserted at the cost of fifteen cents per word for each insertion—name, initials and address each count as one word. Cash should accompany all classified advertisements unless placed by a recognized advertising agency. Not less than ten words are accepted. Advertising for the May, 1938, issue should be received not later than Monday, March 7, 1938.

**RADIO BOOKS**

FOUR NEW RADIO BOOKS—LATEST SERVICING methods. Complete technical reference library. Servicing instruments, fault location methods, trouble analysis. Indispensable. Sensational savings—four volumes, only \$1.95 (Regularly \$2.50.) ELECTRONIC PUBLISHING CO., Box 323-A1, Lincoln, Nebr.

**PATENTS—TRADE MARKS**

All cases submitted given personal attention by members of the firm.

Form "Evidence of Conception" and instructions

"How to Establish Your Rights"—Free

LANCASTER, ALLWINE & ROMMEL  
PATENT LAW OFFICES  
436 Bowen Bldg. Washington, D. C.

To Readers of **RADIO-CRAFT**

Post cards make it easy to answer advertisements which appear in RADIO-CRAFT, without cutting valuable data which you may wish to save. Many times manufacturers request you to "clip the coupon" when answering their ads. Often this means destroying part of an article on the reverse page you may need later for reference. Save your RADIO-CRAFT issues complete. If you should ever want to sell bound volumes, or certain copies of RADIO-CRAFT, the resale value of uncut issues is very much higher than that of mutilated ones. So send for a supply of these free post cards and use them in answering all RADIO-CRAFT advertisements.

**Vest Pocket Adding Machine**



Sturdy Steel Construction. Lifetime Pocket Companion. Adds, Subtracts, Multiplies, Divides. Capacity, 999-999.99. A real machine—guaranteed 5 years. Send name and address. We ship immediately. On delivery, pay postman \$2.50 (plus few cents postage). (Foreign countries send cash.) Your money back after 10 days trial if not satisfied. Thousands of satisfied users. Send for Special Offer to agents.

Free Trial \$2.50  
Send no money  
Total Cost

TAVELLA SALES CO., 21 West Broadway, New York, N. Y.

Please Say That You Saw It in RADIO-CRAFT

**ADVERTISERS' INDEX**

<b>A</b>	
Allied Radio Corporation.....	697
American Microphone Co.....	699
American Television Institute.....	Back Cover
Amplifier Co. of America.....	702
Arcturus Radio Tube Co.....	707
Arrow Sales Company.....	716
Automatic Devices Manufacturers.....	719
<b>B</b>	
Browning Laboratories, Inc.....	714
Brush Development Company.....	720
Burstein-Applebee Company.....	716
<b>C</b>	
Capitol Radio Engineering Inst.....	701
Central Radio Laboratories.....	706
Classified Section.....	718
Continental Carbon, Inc.....	714
Cornell-Dublier Corp.....	712
Coyne Electrical School.....	659, 696
<b>D</b>	
Dodges' Institute.....	717
Allen B. Du Mont Labs., Inc.....	717
<b>E</b>	
Electric-Eye Devices Co.....	720
<b>G</b>	
G&G Genuine Majestic Refrigerator and Radio-Parts Service.....	711
Goldentone Radio Company.....	712
Grenpark Company.....	713
<b>H</b>	
Hammarlund Mfg. Company.....	710
Hygrade Sylvania Corp.....	715
<b>L</b>	
Lancaster, Allwine & Rommel.....	718
Lincoln Engineering School.....	711
<b>M</b>	
Meissner Mfg. Company.....	700
Million Radio & Tel. Labs.....	720
Modell's.....	720
<b>N</b>	
National Plans Institute.....	711
National Radio Institute.....	657
National Schools.....	720
National Union Radio Corp.....	712
New York YMCA Schools.....	700
<b>O</b>	
D. W. Onan & Sons.....	711
<b>P</b>	
Par-Metal Products Corp.....	720
Precision Apparatus Corp.....	716
<b>R</b>	
Radio Circular Company.....	706
Radio City Products Company.....	713
Radio Distributing Company.....	717
Radio Publications.....	718
Radio & Technical Publ. Co.....	702, 717
Radio Training Assoc. of America.....	697
Radolek Company.....	719
Raytheon Production Corp.....	703
RCA Institutes, Inc.....	716
R.C.A. Manufacturing Co., Inc.....	708, 699
Readrite Meter Works.....	704
Remington Rand, Inc.....	717
John F. Rider.....	709
Rosierucian Order.....	708
Radio Constructors Labs.....	713
<b>S</b>	
E. H. Scott Radio Labs.....	698
McMurdo Silver Radio Corp.....	720
Solar Mfg. Company.....	705
Sprayberry Academy of Radio.....	712
Standard Transformer Corp.....	695
Superior Instrument Company.....	701
Supreme Instruments Corp.....	712
Swap & Sell Magazine.....	712
<b>T</b>	
Tavella Sales Company.....	718
Technifax.....	713
Teleplex Company.....	700
Test Equipment Co. of America.....	Inside Back Cover
William A. Thomas Co.....	717
Transducer Corporation.....	701
Triplett Elect. Instr. Co.....	707
Try-Mo Radio Co., Inc.....	711
<b>U</b>	
United Radio Company.....	714
Utah Radio Products Co.....	711
<b>W</b>	
Montgomery Ward & Co.....	710
Wellworth Trading Company.....	712, 717
Weston Elect. Instrument Corp.....	Inside Front Cover
Wholesale Radio Service Co., Inc.....	704
Wright-DeCoster, Inc.....	720

(While every precaution is taken to insure accuracy, we cannot guarantee against the possibility of an occasional change or omission in the preparation of this index.)

circuits that feed both these tubes independently; the rectifier sections of the 6R7 develop bias voltages for the amplifier sections of both tubes.

Inside the control box at the remote station are placed not only the control buttons but also a twin-triode tube, a 6N7, with 2 independent oscillating circuits. One circuit operates at 200 kc. and the other one at 300 kc., both triodes being fed with raw 60-cycle A.C.

Now we arrive at the subject of "A" and "B" phasing mentioned by the author. These designations refer to operation of the oscillators on either half-cycle of the A.C. supply. (The idea may be clarified by considering theoretically that the A.C. modulation for "A" phasing is derived with the plug in the wall outlet in one position; "B" phasing would then result if the plug position in the socket were to be reversed.)

With this as a starting point we then find that by sending currents modulated in "A"- or "B"-phase at either 200 or 300 kc., and either individually or together, over the powerline to the radio receiver it is possible to produce 10 different phase and frequency combinations. Selective circuits at the receiver are then designed to operate the 6N7 and the 6R7 input tubes so that these relay-control tubes properly actuate 3 control relays. These relays then perform the previously-mentioned 8 operations of tuning-in either of 6 different stations, and varying the volume to any desired level; the remaining 2 operations are achieved by means of the gas tube and involve turning the set on or off.—*Editor*

**READERS' DEPARTMENT**

(Continued from page 692)

A selector switch allows the circuit to be switched through the milliammeter. This allows a good test on electrolytics. A second selector allows selection of different load voltages. If one wished an even more complete tester it would be quite practical to use a very low-range meter and rectifier and thereby obtain a means of measuring capacity.

I realize that this tester is nothing new in principle but thought my little improvements might be useful to the Service Industry.

A. J. CHAPMAN

**BRITISH SERVICE HARDER**

Dover, England:

We have a lot of service work to do in this country on American sets, and we usually find that they are simpler jobs than on our own makes. Your valves (tubes) last longer than British-made types and are much simpler in their markings. Do you know that there are over 200 different types of British valves, and every maker has his own way of marking? Thus, in your country, an 80 rectifier is known as an 80 in every make, but here, gosh, in Mullard, it's DW2; Marconi, UR1; Mazda, 150/500; and so on. Nearly every new model of set brings new types of valves.

I have often wished I could come to America to study your methods of servicing, but I expect your Service Men have to put up with just as much as we do; perhaps more. Service Men in Britain are not so well organized as they seem to be in your country, and therefore, we get a lot of competition from outsiders, such as bus and truck drivers. However, sets are getting more complicated, and set repairing is getting more specialized.

Personally, I like American stuff. It is so much better finished off than our own, and lasts better, too. I have just recently serviced a Majestic which is 8 years old and works better than most of its modern English counterparts.

THOMAS SMITH, JR.

Please Say That You Saw It in RADIO-CRAFT

**NOW!**  
**PUSH BUTTON TUNING**  
*for EVERY Radio*



Every customer you have is a prospect for a push button installation. This device makes ANY radio a modern, up-to-the-minute push button set. Installed in a few minutes. Increase your profits by selling this compact, fool-proof unit! Write today for complete details!

Model B6 for 2 Gang Var. Cond. Receivers

LIST \$660

Service Man's Net Price

\$395

Model B6JA for 3 and 4 Gang Var. Cond. Receivers

LIST \$725

Service Man's \$425 Net Price

- Only 3 leads to connect.
- 6 Push Buttons.
- Compact 5 1/4" wide, 1 1/2" high, 2 1/2" deep.
- Adaptable for remote control.
- Manual control of re-

- ceiver as well as push button control.
- Completely shielded by metal container.
- Unit complete with instructions, escutcheon, station tabs, hardware, etc.

**AUTOMATIC DEVICE MANUFACTURERS**

Dept. 4R, 4243 West Ogden Ave., Chicago, U. S. A.

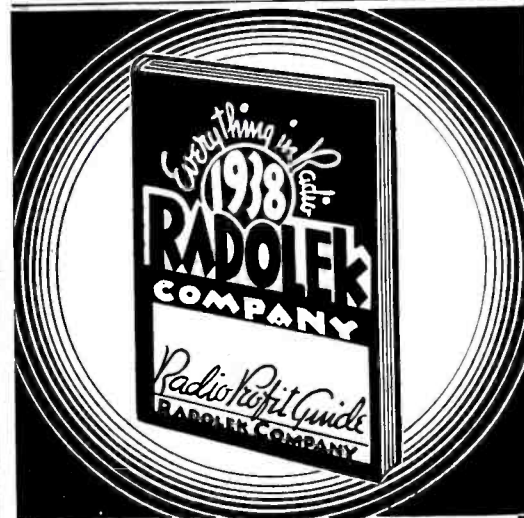

Everything you need in radio. It's all in this new RADOLEK RADIO PROFIT GUIDE. Every repair part for every receiver. Newest radio receivers. New 1938 model public address amplifiers, outputs for 5 to 100 watts. New model public address speakers. Test instruments. Technical books. Special equipment. Leading standard brands. Every item guaranteed. It must be right or we make it right.

And everything under one roof. You get what you want promptly, and exactly what you want. Radolek's immense stock plus Radolek's efficient organization insures you fastest service. 25,000 service men depend on this service and benefit by Radolek's lowest prices. Send now for your copy of Radolek's Radio Profit Guide. It will help you make more money.

**RADOLEK**

601 W. Randolph, Chicago, Dept. C-16

Send me the 1938 Radolek Radio Profit Guide FREE.

Name .....

Address .....

Service man?  Dealer?  Experimenter?

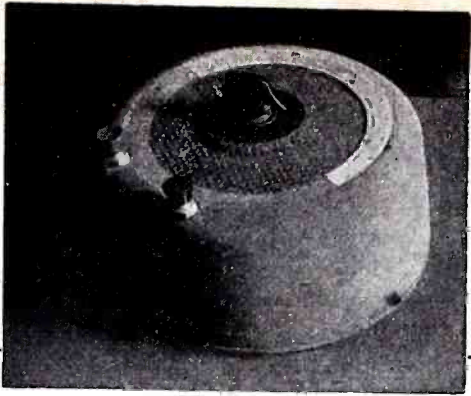

Model TBU 1700  
Size 6½" diameter, 3" high

### The Tremendous Increase

in sales on our Talk-Bak\* Units proves they have the *lasting wear, perfect operation and attractive appearance* we have been claiming for them.

Write for Talk-Bak\* literature and catalog—include your distributor's name.

Wright-DeCoster Distributors are always anxious to cooperate.

### WRIGHT-DECOSTER, Inc.

2251 University Ave., St. Paul, Minnesota  
Export Dept.—M. Simons & Son Co., New York  
Cable Address: "Simontrice"  
Canadian Representatives:  
Wm. F. Kelly Co., 1207 Bay St., Toronto, Ontario  
Taylor & Pearson, Ltd., Edmonton, Alberta

\*Copyrighted

### TYPE 1B PRE-AMPLIFIER-MIXER

**EXTREMELY  
COMPACT AND  
PORTABLE!**

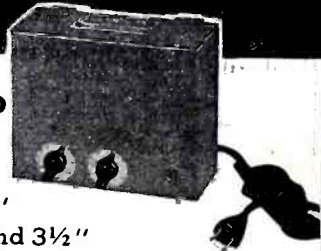

● Only 7" long, 6" high and 3½" deep,

the 1B is a universal a.c.-d.c. self-powered two channel pre-amplifier and electronic mixer. High gain channel, 53 db gain. Low gain channel, 15 db gain... both may be mixed and faded as desired. Frequency response is flat 2 db from 30 to 10,000 cycles. A neat and business-like unit finished in the new British "post office gray."

**\$17.50**

Complete with one each tested Raytheon 6J7 6F8, 6J5

**MCMURDO SILVER CORPORATION**  
2900-G South Michigan Boulevard, Chicago, Illinois

### NOW DU MONT FOR THE SERVICE ENGINEERS!

The Type 164 three-inch Service Oscillograph designed for the service engineer and built with the same care that has made Du Mont instruments the choice of the leading Industrial and Educational Laboratories of the world at a New Low Price.

**Only \$54.50 Dealers Net**

Ask Your Jobber

**ALLEN B. DU MONT LABORATORIES, INC.**  
542 VALLEY ROAD UPPER MONTCLAIR, N. J.

### SERVICING Q & A

(Continued from page 682)

of the 2nd R.F. tube, some reception may be heard. There is no plate voltage on the 1st R.F. tube and but 2 volts on the 2nd R.F. tube. Both plate bypass condensers are OK. Where may the trouble be?

(A.) With the receiver set up for operation, check the field coil of the reproducer by testing the magnetic "pull" of the field "pot" with a screwdriver, or other iron or steel object. A section of the field coil is probably open-circuited, or the tapped lead of the field coil has been ripped off. Plate voltage for the 1st and 2nd R.F. tubes is obtained through this tap on the field coil.

### "INTERMITTENT" OSCILLATOR

(47) A. A. Guntrum, Rimersburg, Pa.

(Q.) I have an Apex model 7A receiver which has been causing trouble for 6 years. The oscillator ceases to function. At times, reception will cut off after 3 hours of operation. Almost every part but the oscillator coil assembly has been replaced in an effort to clear the condition. What do you advise towards remedying the defect?

(A.) The receiver in question employs a type 24A tube as an autodyne or composite detector-oscillator, connected in a circuit shown in Fig. Q.47. The I.F. coil and oscillator coil are a composite unit. Failure of the oscillator portion of the receiver, such as you mention, may be due to any one of several causes. Should the upper portion of the tank coil, designated as L4 in the diagram, open-circuit, then oscillations would cease. No operating voltages would be disturbed in this case. A voltage analysis at the 24A socket would disclose normal readings. This is also true of the cathode bypass condenser. An open-circuited condition of the 0.01-mf. condenser would produce the symptoms described without affecting voltage reading. In some instances, failure of the bypass condenser results in uncontrollable oscillation, only a whistle being heard "over the entire dial" as the receiver is tuned.

The fact that voltages are present at the tube socket proves that L1, the I.F. primary, the oscillator coil primary L3, and the lower tapped portion of L4, are intact. Consequently, the intermittent open-circuiting of the upper portion of the oscillator tank coil L4, or cathode bypass condenser, is probably the cause of your troubles.

Should the composite I.F.-oscillator coil assembly and cathode bypass condenser be found intact, substitute a 2,000-ohm resistor for the 3,200-ohm unit now in the cathode circuit of the 24A detector-oscillator tube. Try, also, a 0.005-mf. cathode bypass.

### Public Address Number

The forthcoming (May) issue of *Radio-Craft* will be of special interest to the Public Address specialist. Order your copy today.

Please Say That You Saw It in RADIO-CRAFT

### PRICES REDUCED

on two Brush microphones — BR2S and B-1. If your jobber can't supply you, write us.

**THE BRUSH DEVELOPMENT CO.**  
3312 Perkins Ave., Cleveland, Ohio

### MILLION

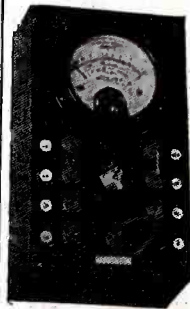

### MODEL S

Pocket Volt-Ohmmeter

0-5-50-500-1000 volts @  
1000 ohms per volt;  
0-1000 ohms  
0-500,000 ohms.

Cash Price **\$7.95**  
Dealers Net

Write for literature on full line.

**MILLION RADIO & TELEVISION**  
559 N. Union Chicago

QUALITY recommends

*Condensers*  
by

WET... DRY  
PAPER  
MICA... THINNER



Please Write for Details

**SOLAR MFG. CORP.** 599-601 Broadway New York City

### ELECTRIC EYE Control Unit Kit

Complete kit with wiring instructions, \$5.98. Completely wired ready for installation, \$8.98. Operates on 110 V. A.C.-D.C. (Not a toy but proven equipment). Used for light controls, alarms, signals, door-openers, and many other electronic applications. Terms: 1/3 cash with order, balance C.O.D. Consult us on your electronic needs—we build to your specifications.

**ELECTRIC-EYE DEVICES CO.**  
51 East 125th Street New York, N. Y.

### WE HAVE The RADIO YOU WANT



How would you like to save up to 50% on Nationally advertised radios, such as Stromberg Carlson, Philco, RCA, Zenith, G E etc. etc. for home, farm and auto: over 400 models to choose from. Also hundreds of electric appliance items for the home. Write today for the new 1938 giant catalog FREE.

MODELL'S Dept. 57 Cortlandt St., N.Y.C.

DO YOU LIKE  
**RADIO**  
&  
**TELEVISION**



If you want to know employment opportunities and requirements in radio and related industries, get National's book of facts. Send for YOUR FREE COPY TODAY Dept. RC-1, 4000 S. Figueroa NATIONAL SCHOOLS Los Angeles

### You need our 1938 Catalog

It illustrates and describes our complete line of

**RACKS • PANELS • CABINETS**

Write for your Free Copy Today!  
**PAR-METAL PRODUCTS CORP.**  
3527 41st St., Long Island City, N. Y.



# 10 DAYS FREE TRIAL!

and this  
**SMASHING  
 GUARANTEE**  
*Stands Behind These*  
**INSTRUMENTS!**

**GUARANTEE:** We guarantee each and every instrument manufactured by us to be exactly as represented. We guarantee that it will reach you in perfect condition. We guarantee to exchange or repair any merchandise returned to us that contains any mechanical or electrical defect in accordance with the standards of honest and sincere manufacturing policies. We pledge ourselves to strict adherence to this guarantee.

TEST EQUIPMENT COMPANY of America

No line of test equipment is better than the company behind it! That is why TECO is the choice of so many servicemen! Now for the first time YOU can buy TECO equipment DIRECT FROM THE MANUFACTURER AT PRICES THAT SAVE YOU 50%. Our years of engineering ability, the experience of our trained technicians, our factory-to-you method of selling—

all combine to make TECO the best "buy" on the market. Remember, you may buy the TECO Instruments you need and try them for 10 days! If you find one does not meet your specific requirements, YOU MAY RETURN IT TO US FOR FULL CREDIT ON ANY OTHER TECO EQUIPMENT WHICH WE MAKE! Could anything be more fair?

## TECO MULTIMETER T-15

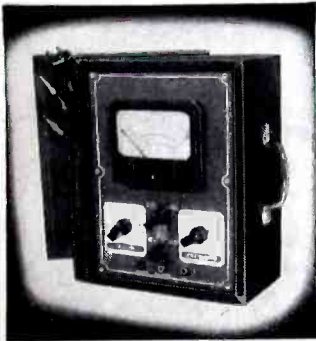

Here's the unit you need for rapid, accurate measurements. A 1,000 ohms per volt type instrument featuring d'Arsonval type movement 0-1 Milliampere. Accuracy 2%; and attractive etched metal panel. For use on 110 V. 60 cycle A.C.

**3 RESISTANCE RANGES**  
 0-500 ohms, 0-50,000 ohms, 0-5 megohms  
**HIGH AND LOW CAPACITY SCALES**  
 .005-1 mf. and .05-200 mf.  
**COMPLETE AC and DC VOLTAGE and CURRENT RANGES**  
 DC Voltage: 0-15, 0-150, 0-750 volts DC  
 AC Voltage: 0-15, 0-150, 0-750 volts AC  
 DC Current: 0-1, 0-15, 0-150, 0-750 Ma., DC  
 AC Current: 0-15, 0-150, 0-750 Ma., DC  
**THREE DECIBEL RANGES**  
 -10 to 18 Db., +10 to 38 Db., +20 to 58 Db.  
**INDUCTANCE:** .5-1000 Henries

TECO Multimeter comes complete in carrying case with test leads and instructions. Size 11 1/2 x 9 1/2 x 5 1/2. Shpg. wgt. 8 lbs. Our net price.....

**\$13.60**

## The New TECO T-25 SIGNAL GENERATOR

A new R.F. and A.F. Signal Generator with d'Arsonval output meter built in.

### SPECIFICATIONS

Radio and intermediate frequencies, 100Mc to 60Mc in 6 bands. All on fundamentals (no harmonics used).

Audio frequencies in 6 bands: 60 cycle sine wave, with percentage modulation control: 100, 400, 1000, 5000 and 7500 cycles, saw-tooth modulation.

R.F. and A.F. independently accessible. Switch selection of all R.F., I.F. and A.F. and all direct reading on panel and dial.

Built-in output meter of exclusive design, .5-2 volts r.m.s. in newest molded square Bakelite case. Flat characteristics: 20-7500 cycles; down 2 db. at 10,000 cycles. Operates directly from voice coil of set or may be used generally as 2 volt AC meter. Accuracy 2%.

Attenuator for R.F. and I.F. works on all bands. Leakage is extremely low.

Operates on 90-130 volts AC or DC. Sine wave modulation not present when Generator is worked on DC but saw tooth modulation is present in both instances.

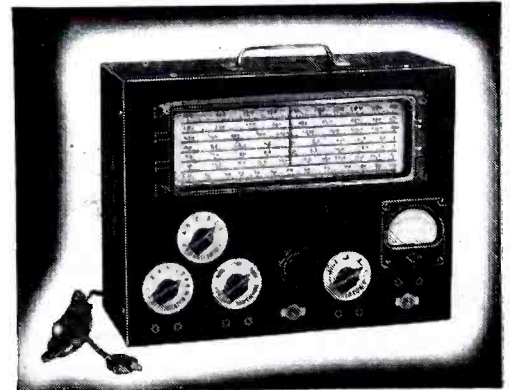

Black shielded cabinet trimmed with crystalline panel featuring German silver escutcheon plates; test leads. Uses 1-6J5G R.F. Oscillator, 1-25Z6 Rectifier and 1 neon modulator tube.

Latest Crowe 10" oblong vernier dial with full vision and six indications of calibrations.

Model T-25, complete with 3 tubes, test leads, handle, instructions. Size: 9x11x5 1/2". Shpg. wgt. 18 lbs. Our net price . . . .

**\$17.45**

## TECO T-10 TUBE TESTER

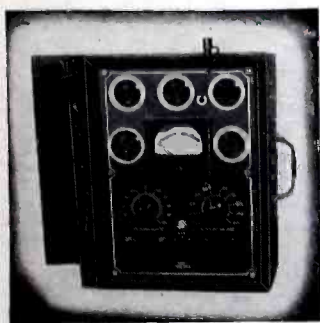

A genuine achievement! For accurate and rapid work. Has d'Arsonval moving coil meter. Tests all types of receiving tubes. For use on 110v. 60 cycle AC.

### FEATURES

- ★ Tests all 4, 5, 6, 7s-7L and octal base tubes.
- ★ Tests all Diodes, Triodes, Pentodes and Tetrode receiving tubes, as well as many transmitting types.
- ★ Separate Neon Test for leakage or shorts between elements.
- ★ English reading meter, with "BAD-7-GOOD" scale.
- ★ Minimum number of adjustments, without impairing efficiency or accuracy of test.

- ★ Rugged, foolproof construction. Built for a lifetime of use.
- ★ Attractively designed etched panel, metal carrying case and cover.
- ★ Compact and lightweight. Ideal for service laboratory or field servicing.
- ★ Supplied with complete instructions and tabular data for every known receiving type of tube, including many transmitting types.
- ★ Size: 11 1/2 x 9 1/2 x 5 1/2. Shpg. wgt. 9 lbs. Our net price .....

**\$11.75**

## TECO T-20 SET TESTER

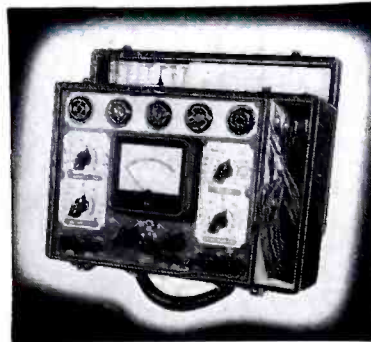

A whole testing laboratory all in one unit. Combines TECO Model T-10 Tube Tester and TECO Model T-15 Multimeter. Specifications are exactly the same as on both of the models mentioned. Never before such a sensational value! Comes complete with unusually large 4" d'Arsonval type meter and attractive etched panel; instructions. For use on 110v. 60 cycles. A.C. Size: 14x9 1/2 x 5 3/4". Shpg. wgt. 20 lbs. Our net price .....

**\$21.45**

## TECO POCK-O-METER



A new pocket size volt-ohm-milliammeter that includes AC measurements and is the lowest priced, full-service instrument ever offered! Has a 3" d'Arsonval movement 0-1 milliammeter. Comes with attractive etched panel.

### SPECIFICATIONS

- 5 Linear DC voltage ranges: 0/1.5/15/25/75/500 volts
  - 5 Linear AC voltage ranges: 0/1/10/100/500/2,500 volts
  - 4 DC Current ranges: 0/1/10/100/500 Ma.
  - 2 Resistance ranges: 0/500/500,000 ohms. (low ohms read to 1 ohm).
- Pock-o-meter supplied complete with batteries, test leads and instructions. Size 6 1/2 x 3 1/2 x 2 1/2"; shpg. wgt. 5 lbs. Our net price .....

**\$8.45**



**TEST EQUIPMENT COMPANY of America**

139 CEDAR STREET

RC-4

NEW YORK, N. Y.

# Read What TRI-TOWN RADIO AMATEUR CLUB Says About Their A.T.I. TELEVISION OUTFIT

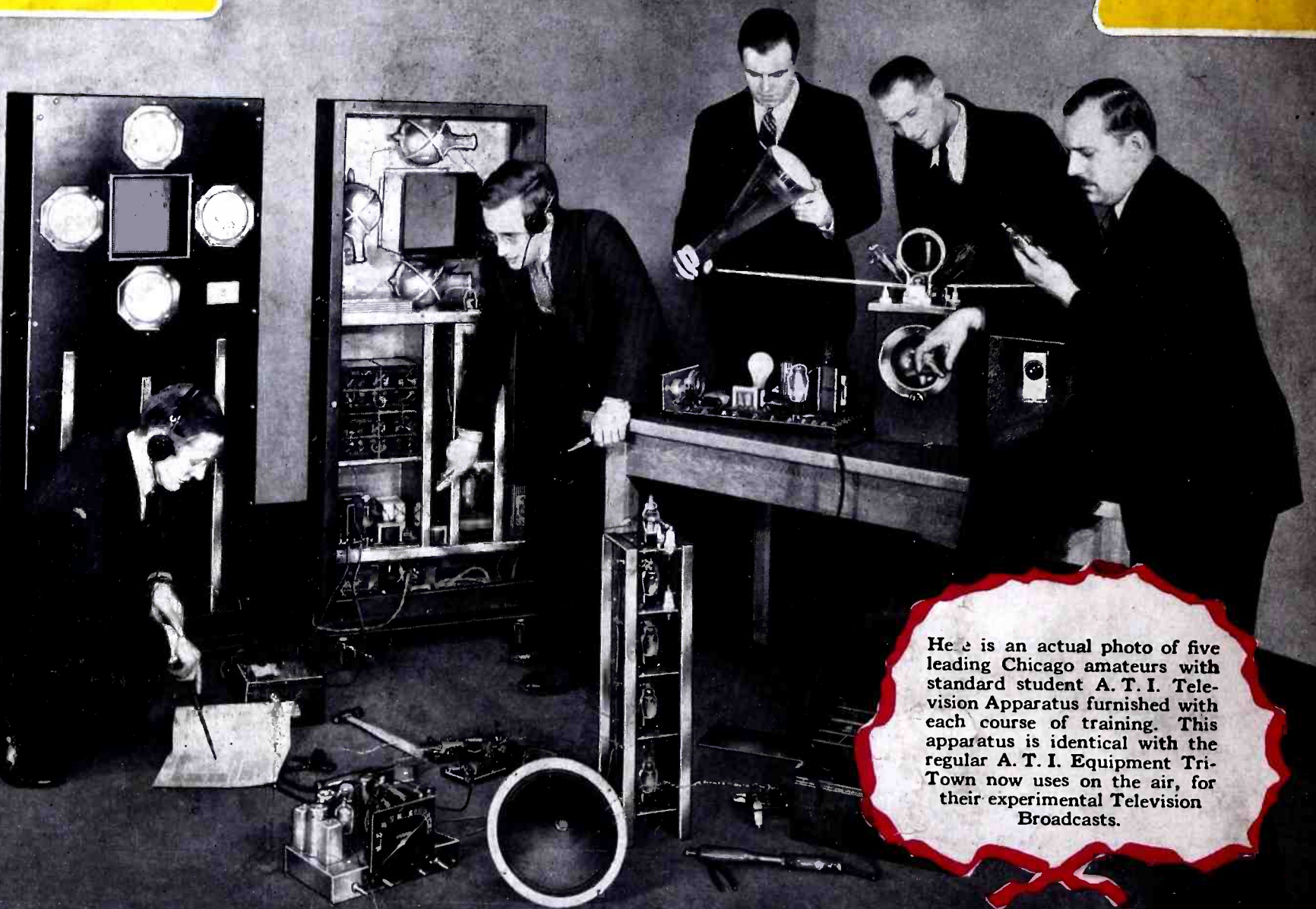

Here is an actual photo of five leading Chicago amateurs with standard student A. T. I. Television Apparatus furnished with each course of training. This apparatus is identical with the regular A. T. I. Equipment Tri-Town now uses on the air, for their experimental Television Broadcasts.

- 

**Dr. Norman F. Ellemeir** says, "As an optical expert, I find the A.T.I. equipment in line with the finest precision standards. It produces an exceptionally good image. The sensitivity is remarkable."
- 

**Edward Gibbons, W9TAK**, says, "I have worked with A.T.I. equipment. It lends itself perfectly to experimental work and hundreds of tests which give you a first hand practical knowledge of television."
- 

**E. F. Wiechmann, W9RLA**, says, "I am tremendously impressed by the size and quality of your equipment. The cathode ray tube and four photo electric cells alone are worth the entire price you ask for the complete machine and training."
- 

**Mr. A. G. Roberts, W9VMF**, says, "I favor A.T.I. television equipment because it is thoroughly modern. Every part is as good as any experimenter would want."
- 

**G. L. Dosland, W9TSM**, says, "This equipment is practical and lends itself admirably to experimental uses and the study of television."

**We Invite All Men to Write to Us**

The Tri-Town Radio Amateur Club, W9MWJ, of Ridge Park, Chicago, is the only Amateur Club, we believe, that has its own Television Experimental Laboratories. Their television test broadcasts on the air will mark the beginning of local amateur cooperation dedicated to the progress and perfecting of Television. The enthusiasm these "hams" show over their A.T.I. Television Equipment, and their appreciation of the cooperation A.T.I. Engineers have extended to them is well reflected in their statements. We have hundreds of letters from A.T.I. men throughout the nation, expressing their enthusiasm about A.T.I. Equipment and A.T.I.'s new method of learning Television at home, with practical equipment. The American Television Institute cordially invites all men who are interested in Television to write for complete information on the A.T.I. New Method of Television-Radio Training.

**A.T.I. Equipment Includes:**

Complete television transmitter and receiver, cathode ray tube with large 7" screen, sweep circuits, photo electric cells, gas arcs, 50 watt radio transmitter, super-heterodyne receiver, hi-gain transmission amplifier, projector, Mazdas, lenses, loud speaker, meters, phones, and complete RCA tubes. Large five foot steel rack and panels with separate television receiver. Complete text books and technical manuals. This equipment is sent to you at home, and is yours to keep, and is worth \$1,000 to anyone taking this training. You learn by actually doing television work with your own equipment at home under our direction. Television can not be properly learned from texts alone, that's why we give you all this equipment in addition to a full engineering course in Radio, Television and Electronics with final training in our laboratory in Chicago under the direction of internationally famous television engineers. Employment service given to graduates.

**You Can Make 350 Experiments . . .**

With this A.T.I. Equipment, you can make over 350 amazing, interesting Television and Electronic experiments right in your own home. You can produce your own Television program for a local audience . . . transmitting and receiving the faces of your friends. You can build a complete Television Receiver that picks up any modern 441 line signal . . . Television Transmission and Reception Systems, Television Amplifiers, Radio Transmitters, Television Pick-ups, Photo-Electric Relays, Light Beam Telephone, Magic Lantern, Grid-Glow Alarms, Sound Amplifiers, Photo-Electric Photometers. You can make hundreds of comparison tests that show you Television and Radio in a quick, simple way . . . much easier to understand than just mere words in a book. It costs you nothing to thoroughly investigate this opportunity. You cannot afford to pass it up. *Send Coupon Now.*

**A. T. I. TELEVISION - RADIO TRAINING IS AMAZINGLY LOW-PRICED ON EASY TERMS TO SUIT YOU**

**AMERICAN TELEVISION INSTITUTE**  
433 E. Erie St., Dept. RC 438, Chicago, Ill.

I am interested in your special offer of 4 free lessons in Television. Please send literature and complete details. No obligation.

Name ..... Age .....

Address .....

City ..... State .....

**4 Free LESSONS in TELEVISION**  
**THIS OFFER GOOD FOR A LIMITED TIME ONLY!**  
**DON'T DELAY! SEND THE COUPON NOW!**